



Technical Report
FCRC-TR 96-01

Smouldering & Flaming Fires - an Experimental Program

FCRC Project 4
Fire Safety System Design Solutions
Part A – Core Model & Residential Buildings

Fire Code Reform Research Program
October 1996

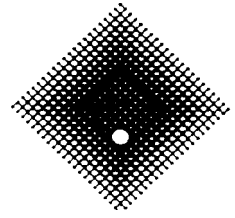

Flaming Fires

an Experimental Program

Ian Moore
Vaughan Beck

RESEARCH REPORT

February 1996

CESARE Report 96-001

Centre for
Environmental
Safety & Risk
Engineering



Important Notice

This Report has been prepared for work commissioned by Fire Code Reform Centre Limited and has been released for information only.

The statements and conclusions of the Report are those of the author(s) and do not necessarily reflect the views of Fire Code Reform Centre Limited, its Board of Directors or Members.

Neither the authors, Fire Code Reform Centre Limited, nor the organisations and individuals that have contributed, financially or otherwise, to production of this document warrant or make any representation whatsoever regarding its use.

Background

The Fire Code Reform Research Program is funded by voluntary contributions from regulatory authorities, research organisations and industry participants.

Project 4 of the Program involves development of a Fundamental Model, incorporating fire-engineering and risk-assessment methodology, for performance prediction of building fire safety system designs in terms of Expected Risk to Life (ERL) and Fire Cost Expectation (FCE). Part 1 of the Project relates to Residential Buildings as defined in Classes 2 to 4 of the Building Code of Australia.

Preparatory to development of the Model a significant Experimental Fire Test Program was undertaken in realistic residential layouts at VUT's Fire Test Facility, Fiskville, Victoria. This Technical Report was prepared following completion of that part of the Experimental Program that related to Smouldering and Flaming Fires.

Acknowledgements

Since inception of the Fire Code Reform Research Program in 1994 the Australian Building Codes Board has been its principal financial contributor. Substantial funds have also been provided by Forest and Wood Products Research and Development Corporation and generous contributions have been received from a number of industrial and financial entities and individual donors. Funding for the Experimental Fire Tests described in this Report was received from the Federal Government's Australian Building Research Grants Scheme

The Board and management of Fire Code Reform Centre Limited acknowledge with sincere thanks receipt of all these financial contributions. The company also acknowledges the kind permission to re-produce and publish this document received from the Centre for Environmental Safety and Risk Engineering at Victoria University of Technology.

Comments

Comments on the content or other aspects of this document are always welcome and should be addressed to:- Fire Code Reform Centre Limited, Suite 1201, 12th Floor, 66 King Street, Sydney, NSW 2000, Australia. Tel: +61 (2) 9262 4358 Fax: +61 (2) 9262 4255

SMOULDERING AND FLAMING FIRE EXPERIMENTS

PHASE 1 EXPERIMENTAL PROGRAM

A Project Funded by the

AUSTRALIAN BUILDING RESEARCH GRANTS SCHEME

Being Part of

FIRE CODE REFORM CENTRE LTD

PROJECT 4: FIRE SAFETY DESIGN SOLUTIONS FOR THE BCA

**PART 1: CORE MODEL AND RESIDENTIAL BUILDINGS
CLASS 2 - 4 BUILDINGS**

by

Ian Moore and Vaughan Beck

Centre for Environmental Safety and Risk Engineering



**Victoria University of Technology
Australia**

CESARE Report No. 96-001

February, 1996

Copyright © 1996, Victoria University of Technology.

Abstract

The project detailed in this report forms the Smouldering and Flaming Fire Experiments, Phase 1 - Experimental Program? being part of the Fire Code Reform Centre Ltd. (FCRC), Research - Project 4, Fire Safety Design Solutions for the BCA, Part 1: Core Model and Residential Buildings, Class 2 - 4 Buildings. Funding for the phase one sub-project was obtained from the Australian Building Research Grant Scheme.

This report describes a series of full - scale fire experiments (31 experiments in total) that were designed to generate both comprehensive and reliable data on both the growth and spread of fires in residential buildings and the response of building subsystems to these fires. Two types of fires, smouldering and flaming (non - flashover) fires, with various ventilation conditions and fuel loads were investigated. Suggestions are also made on areas of possible future investigation and research.

The comparison between the experimental results (reported herein) and model prediction will be undertaken in the Fire Code Reform Centre project.

Contents

1. AIM	8
2. SCOPE OF PROJECT WORK	9
2.1 Background	9
2.2 Development of	9
2.3 Outline of	10
3. EXPERIMENTAL BUILDING FIRE FACILITY AND INSTRUMENTATION SETUP	13
3.1 BUILDING STRUCTURE	13
3.2	19
3.2.1	19
3.2.2 Instrumentation Room	23
3.2.3 Smoke Management System	24
3.2.4	24
3.2.5 Sprinkler	25
4. INSTRUMENTATION	26
4.1	26
4.2	27
4.2.1 Thermocouples	27
4.2.2 Radiometers	32
4.2.3 Weigh Assembly	32
4.2.4 Chemical	32
4.2.5 Smoke Obscuration	34
4.2.6 Video Recording	34
4.2.7 Pressure Measurements	34
4.2.8	35
4.2.9 Weather	35
5. EXPERIMENTAL PROGRAM	36
5.1 FIRE STATISTICS	36
5.2 FIRE EXPERIMENTS	38
5.2.1	39
5	39
5.2.1.2 Fire Simulation Experiments	39
5.2.2 Flaming Fires	43
5.2.2.1	43
5.2.2.2 Fire	43
5.2.3 Flaming Fire Experiments	48
5.2.3.1	48

5.2.3.2	Experiments	48
6.	RESULTS OF SMOULDERING FIRE EXPERIMENTAL PROGRAM	50
6.1		50
6.1.1		50
6.1.2	Concentration	50
6.1.3		51
6.1.4	Summary	51
6.2		52
6.2.1		52
6.2.2	Temperatures	52
6.2.3	Carbon	53
6.2.4	Oxygen Concentration	53
6.2.5	Carbon Dioxide Concentration	54
6.2.6		54
6.2.7	Smoke Obscuration	54
6.2.8	Detector Activation	55
7.	RESULTS OF SMALL ROOM FLAMING FIRE EXPERIMENTS	56
7.1	COMMERCIAL PRODUCT EXPERIMENTS	56
7.1.1		56
7.1.2	Carbon	56
7.1.3	Oxygen Concentration	57
7.1.4	Temperatures	57
7.1.5	Visual Observations	57
7.1.6	Summary	58
7.2	SIMULATION EXPERIMENTS	58
7.2.1		58
7.2.2	Temperatures	59
7.2.3	Temperatures in the Corridor	60
7.2.4	layer	61
7.2.5	Carbon Monoxide Concentration	61
7.2.6		62
7.2.7	Smoke Obscuration	62
7.2.8	Detector Activation	63
7.2.9	Sprinkler Activation	64
7.3	CHAIR FIRE SIMULATION EXPERIMENTS	65
7.3.1		65
7.3.2	Temperatures	65
7.3.3	Temperatures in	66
7.3.4	layer	67
7.3.5	Carbon	67
7.3.6	Carbon Dioxide and Oxygen Concentrations	67
7.3.7	Smoke Obscuration	68
7.3.8	Detector Activation	69
7.3.9	Sprinkler Activation	70
8.	RESULTS OF LARGE ROOM FLAMING FIRE EXPERIMENTS	71
8.1	COMMERCIAL PRODUCT EXPERIMENTS	71

8.1.1 Mass Loss	71
8.1.2 Carbon	71
8.1.3 Oxygen Concentration	72
8.1.4 Average Room Temperatures	72
8.1.5	73
8.1.6 Summary	74
8.2 LARGE ROOM CHAIR FIRE	74
8.2.1	74
8.2.2 Average	75
8.2.3 Temperatures	76
8.2.4	76
8.2.5	77
8.2.6 Carbon Monoxide Concentration	77
8.2.7	78
8.2.8	78
8.2.9 Detector Activation	79
8.2.10	79
8.2.11 Sprinkler Activation	80
9. SUMMARY	81
9.1 SUMMARY OF	81
9.2 SUMMARY OF RESULTS	82
9.2.1 Commercial	82
9.2.2	83
9.2.3	84
10. CONCLUSIONS	86
11. ACKNOWLEDGMENTS	87
12. REFERENCES	87

LIST OF APPENDICES

- Appendix A - Instrumentation**
- Appendix B - Smoke Detector Test Certificate**
- Appendix C - Air Handling / Smoke Control Commissioning Report**
- Appendix D - Fire Statistics Used in the Development of the
Experimental Program**
- Appendix E - Fuel Load Details**

LIST OF TABLES

TABLE 4-1:- IDENTIFICATION CODES OF	26
TABLE 5-1 DOOR AND VENTILATION	FIRE
EXPERIMENTS	41
FLAMING	44
TABLE 5-3:LARGE ROOM	49
FIRE	55
EXPERIMENTS	64
TABLE 7-1:	64
EXPERIMENTS	64
TIMES FOR	KITCHEN FIRES
TABLE 7-3 DETECTOR	CHAIR FIRE
EXPERIMENTS	69
TABLE 7-4: TIMES AND TEMPERATURES	70
THE	CHAIR
TABLE 8-1: DETECTOR ACTVATION	79
FIRE EXPERIMENTS	FOR
TABLE 8-2: TIMES	80
THE ROOM	

LIST OF FIGURES

1 LEVEL	PLAN	14
FIGURE 3-2 LEVEL 1M		15
FIGURE 3-3 LEVEL 2 FLOOR PLAN		16
LEVEL 3		17
FIGURE 3-5 SOUTHERN ELEVATION		18
WINDOW	102)	19
FIGURE 3-8	102	20
PLATFORM		21
FIGURE 3-9 EXPERIMENTAL		22
INTERIOR VIEW OF THE INSTRUMENTATION ROOM.		23
FIGURE 4-1 LEVEL 1		27
FIGURE 4-2 LEVEL 1		28
FIGURE 4-3 LEVEL 1M		28
LEVEL 2		29
FIGURE 4-5 LEVEL 3		29
RACK T/C07	102	30
RACK T/C 08	102	30
FIGURE 4-8 THERMOCOUPLE RACK T/C09	101	31
RACK T/C10	101	31
10 THERMOCOUPLE RACKS T/C12 - T/C14	103	32
FIGURE 5-1 CHAIR	AND	FLAMING
EXPERIMENTS		41
FIGURE 5-2 CHAIR	SMOULDERING	42
VIEW OF KITCHEN	IN	
FLAMING FIRE EXPERIMENTS		45
FIGURE 5-4: PHOTOGRAPH OF MOCK-UP		FIRE
EXPERIMENTS		46

NOTE: Those **figures** (graphs) relevant to Sections 6 to 8 of this report are not listed here; they are located at the end of this report.

A I M

The aim of this experimental research program was to conduct real fire experiments, which involved both smouldering and non-&shover fires, in a realistic multi-storey residential layout (representative of Class 2 to 4 buildings, as defined in the Building Code of Australia) using the Centre for Environmental Safety and Risk Engineering (CESARE) Experimental Building-Fire Facility (EBFF) at Fiskville.

Comprehensive data was recorded during these experiments. This data will be used to both validate and develop mathematical models for fire growth and spread and the response of building components and sub-systems. Model validation and development will be conducted as part of the Fire Code Reform Centre Research Project 4, Part 1, Core Model and Residential Buildings, Class 2 - 4.

2. SCOPE OF PROJECT WORK

2.1 Background

This project was funded by the Australian Building Research Grants Scheme (ABRGS). The project was designed to be an integral part of the Fire Code Reform Centre Ltd (FCRC), Project 4, Fire Safety Design Solutions for the BCA (Building Code of Australia), Part 1: Core Model and Residential Buildings (Class 2 - 4 Buildings). FCRC Project 4, Part 1 consists of the three phases, namely:

- Phase 1: Experimental Program, Smouldering and Flaming Fire Experiments
- Phase 2: Experimental Program, Flashover Fire Experiments
- Phase 3: Modelling and Computer Program

This report details Phase 1 of Project 4, Part 1; namely Experimental Program, Smouldering and Flaming Fire Experiments.

The FCRC was established in 1994 by the Australian Building Codes Board and industry to undertake a major program of reform of the existing fire provisions of the BCA (by adopting an engineering approach) and to introduce new **engineering-**based design codes for the cost-effective design of fire safety and protection in buildings.

The **Centre** for Environmental Safety and Risk Engineering (CESARE) was appointed as the major research provider to the FCRC and to provide leadership to Project 4. The CESARE applied to the ABRGS to undertake an experimental program on smouldering and flaming **fires** on the basis that such an experimental program was an integral part of the FCRC Project 4, Part 1.

2.2 Development of the Experimental Program

Many models have been developed to predict the fire environment in a room and some models have the capability to predict the environment in adjoining rooms. In the development of these models there have been limited attempts to validate these models by comparing the results with experimental results. **In** many cases experiments have been conducted in single, isolated rooms of standard size where standard fuel items have been used (such as timber cribs, propane burners, liquid pool fires and polyurethane slabs). There have been limited attempts to collect comprehensive data of the fire environment arising **from** the combustion of realistic items of **furniture** in realistic building layouts using a variety of ventilation conditions. The experimental program (Phases 1 and 2) was designed to rectify this deficiency.

Accordingly, this experimental program was designed to collect comprehensive data of the fire environment arising **from** the combustion of realistic items of **furniture** in a realistic building layout using a variety of ventilation conditions. The experimental data collected during this experimental program will be compared with the predictions obtained from computer models. The aim of this comparison is to modify/validate computer models to predict the fire environment arising **from** the combustion of realistic items of **furniture** in a realistic building layout using a variety of ventilation conditions.

Both experimental programs, namely Phase 1 Flaming and Smouldering Fires and Phase 2 Flashover Fires were undertaken on the basis that only experimental data will be collected during these experimental programs. This data will be further analysed and compared with model predictions during Phase 3 of the project, namely Modelling and Computer Program.

2.3 Outline of the Experimental Program

The project was designed to conduct **real** fire experiments in a realistic residential building layouts, typical of Class 2 - 4 buildings. The Building Code of Australia (BCA) defines Class 2 - 4 buildings as:

Class 2:- A building containing 2 or more sole occupancy **units** each being a separate dwelling excluding Class 1.

Class 3:- A residential building, other than Class 1 or 2, which is a common place of living of a number of unrelated persons, including:

- a) **Boarding** house, guest house, hostel, lodging house
- b) **Residential** part of a hotel or motel
- c) Residential part of a school
- d) Accommodation for the aged, disabled or children
- e) Residential part of a health care building which accommodates members of staff

Class 4 :- A dwelling in a building that is Class 5, 6, 7, 8 or 9 if it is the only dwelling in the building.

The following conditions were investigated during the experimental program:

1. Fire types

Investigate typical fire scenarios including

- smouldering **fires**
- non&shover **fires**

2. Ventilation

Investigate the effects of various combinations of doors open and/or closed.

3. Sprinklers

Investigate the time of operation and the effects of sprinklers on fire growth.

4. Smoke Management

Investigate the effects of smoke management subsystems, including stair pressurisation, on smoke spread . Record the time of operation and effectiveness of operation.

5. Different fuel types

Different fuel types were investigated which are representative of combustible items found in bed rooms, lounge rooms and kitchens of Class 2 - 4 buildings. Fuel types to be included in the program include bedding, a polyurethane mattress, an upholstered chair, sofa, cooking oil and particle board shelves.

6. Realistic Building Layout

To represent a realistic building layout use was made of CESARE's Experimental Building- Fire Facility (EBFF). The EBFF is a three-storey building which has been fitted-out to be representative of an apartment building containing all conventional services. The EBFF contains a wide range of **instruments** and a data acquisition system which is used to record comprehensive data on the fire environment in the facility.

7. Different Room Sizes

As noted previously, many fire experiments have been conducted in a “standard” size room. In order to investigate the influence of room size on the resulting fire environment, it was decided to investigate the **fire** environment conditions in a “large-size room”.

The combination of the above factors led to the development of an experimental program containing a broad range of experiments in which comprehensive data was collected on the fire environment arising from the combustion of realistic items of furniture in a realistic building layout using a variety of ventilation conditions. Such an experimental program provides an ideal opportunity to subsequently develop/validate computer programs to predict the **fire** environment **in** buildings under realistic conditions.

In consideration of the desire to conduct as comprehensive an experimental program as possible, and recognising the resource constraints of the grant, it was decided to conduct the majority of the experiments using simulated furniture. In order to select an appropriate configuration for the simulated furniture it was decided to conduct a number of comparative experiments in which the performance of actual items of furniture were compared with simulated pieces of furniture. The criterion for selection was that the simulated piece of furniture should give results which are similar to, but (in general) conservative, when compared with the performance of actual pieces of furniture.

A total of 31 experiments (12 smouldering, 19 non-flashover) were conducted. During each of the experiments the following parameters were recorded (where practical):

- . Mass loss
- Temperature distribution
- Gas concentrations:
 - Carbon monoxide
 - Carbon dioxide
 - Oxygen
- Smoke obscuration
- Times of activation:
 - Smoke detectors
 - Thermal** detectors
 - Sprinklers

- Air velocity

The comparison between the experimental results (reported herein) and model prediction will be undertaken in the Fire Code Reform Centre project.

An extensive amount of data was **collected** during the experimental program. While some smoothing and **averaging** of the experimental data has been undertaken, not all of the experimental data obtained is reported herein for the sake of brevity.

3. EXPERIMENTAL BUILDING FIRE FACILITY AND INSTRUMENTATION SETUP

3.1 BUILDING STRUCTURE

The Experimental Building-Fire Facility (EBFF), which is of steel and concrete construction, is 12 metres high, with a plan area of 21m by 15m.

The Facility consists of three main levels with a mezzanine level constructed between levels 1 and 2 because of the 5.2m inter floor height between levels 1 and 2. This **mezzanine** level is denoted as Level 1M (Level 1 Mezzanine). The **inter-floor** height between Levels 2 and 3 is 3.6m. The configuration of the levels are intended to represent the layout of part of a **typical** apartment building. Given in Figures 3.1 - 3.4 are the floor plans of various levels and Figure 3.5 is the southern elevation of the building. The layout of the building consists of four rooms and a corridor for Levels 1, 1 M, and 2; the third level consists of a corridor only.

The **structural** frame of the EBFF consists of steel sections used as main beams and columns. The main floors consist of suspended concrete slabs using light weight galvanised steel decking as permanent formwork. The wall construction of the **fit out** comprises 75 x 32 x 1.2 mm steel studs to which standard and fire-rated plasterboard linings are attached internally. The external south wall facade consists of 9 mm compressed cement sheeting, while the external north and east facades consisted of steel cladding.

One corner of the structure of the EBFF consists of a services core. The walls of the service core are constructed of lightweight aerated concrete block work. The service core comprises a stairwell, lift well, air-handling/smoke spill shafts, and services compartment. All levels are linked by a composite steel and concrete staircase in the stairwell shaft. The stairwell also contains a pressurisation sub-system for the control of smoke. The air-handling equipment comprises supply air duct work, return air shafts, and associated dampers distributed via the services compartment to Levels 1, 1M, and 2 (Level 3 is not serviced). The air-handling sub-system is designed to operate as a zone **control** smoke management sub-system and along with the smoke spill fan and stairwell pressurisation system is used for smoke management.

The EBFF is also equipped with a sprinkler sub-system feeding Levels 1, 1M, and 2. The sprinkler sub-system, corresponding to a low density grid is capable of maintaining a supply pressure of 800 kPa when in **full** operation.

Figure 3-1 Level One Floor Plan

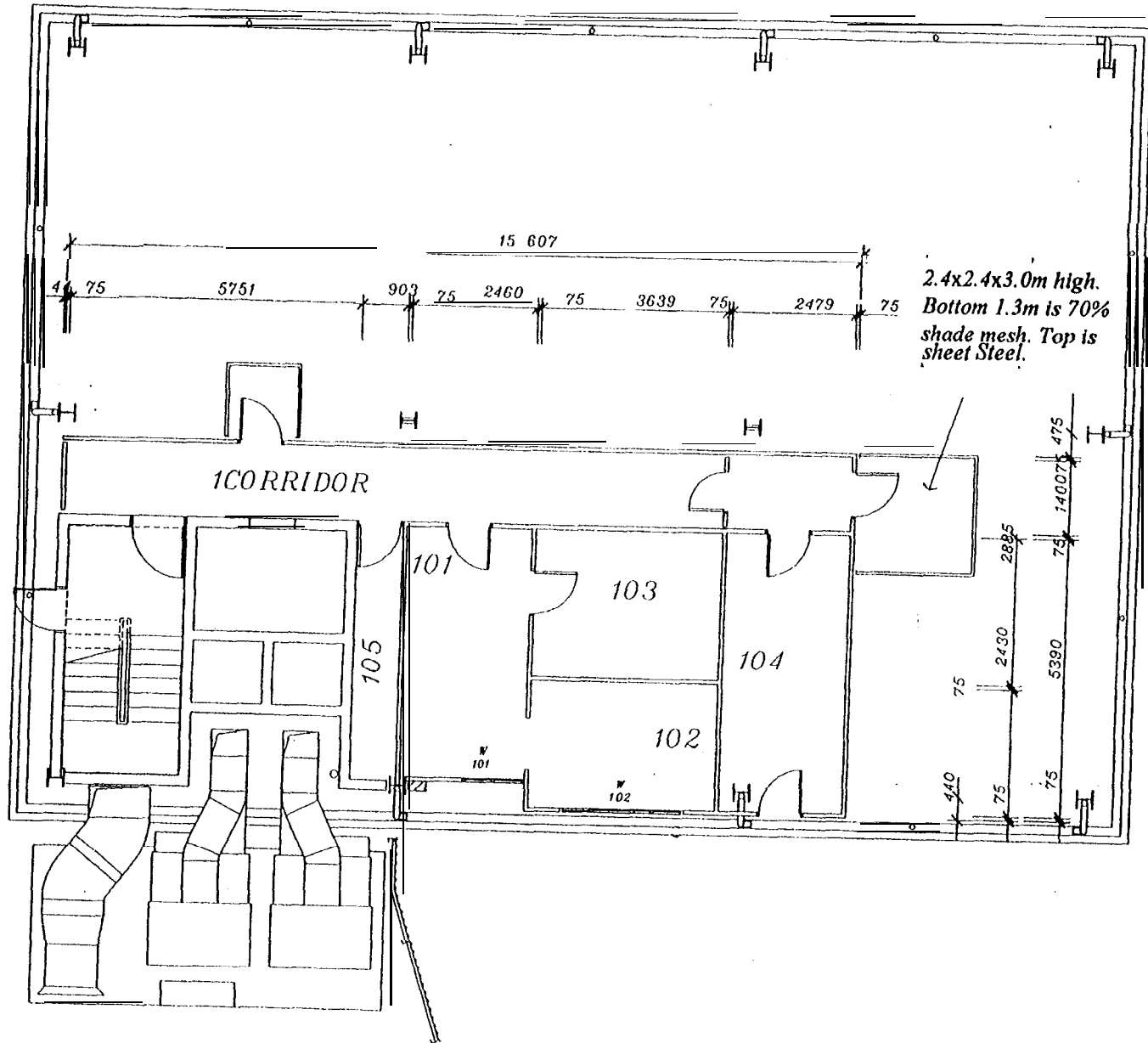

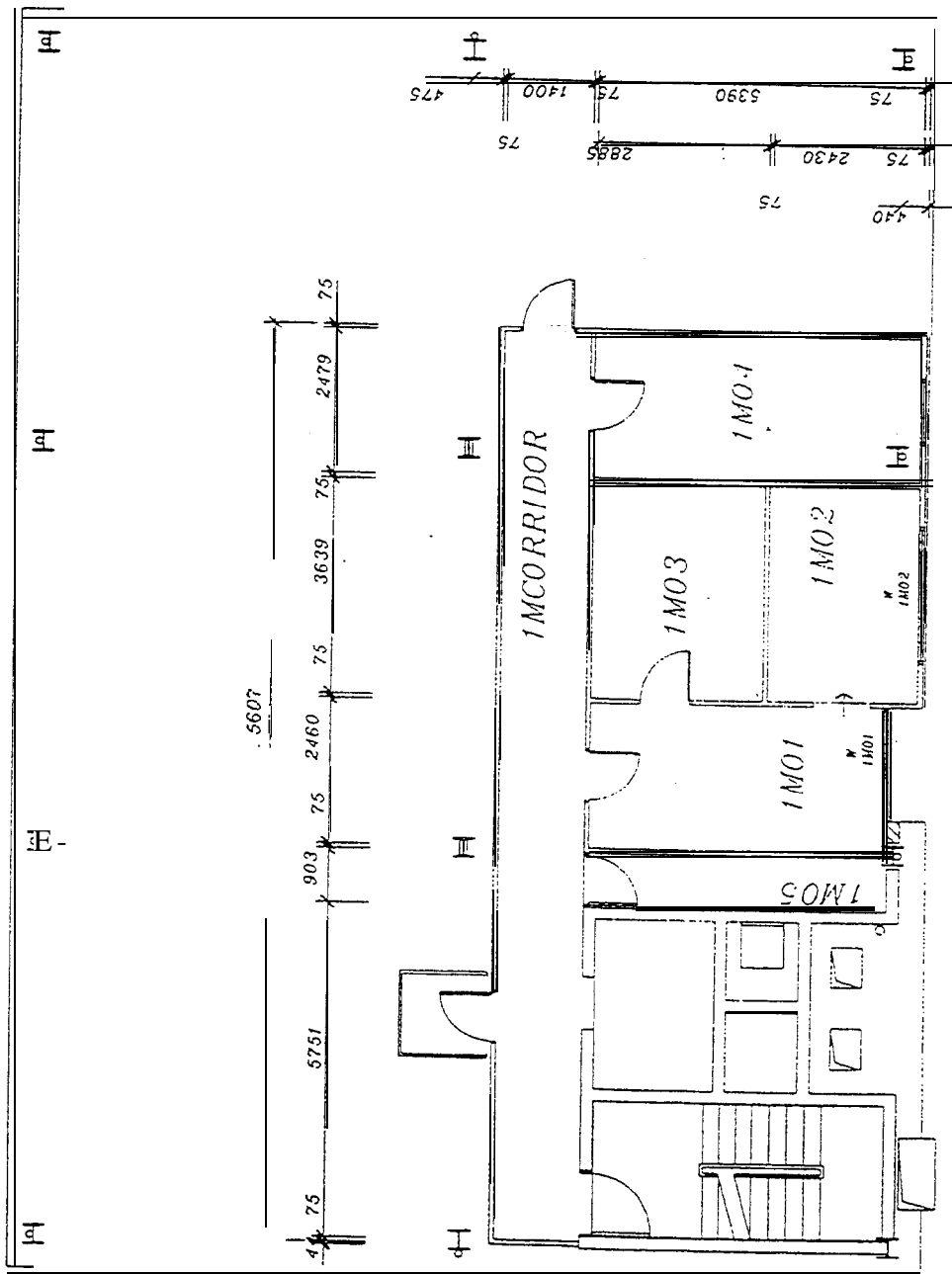

Figure 3-2

Floor Plan.

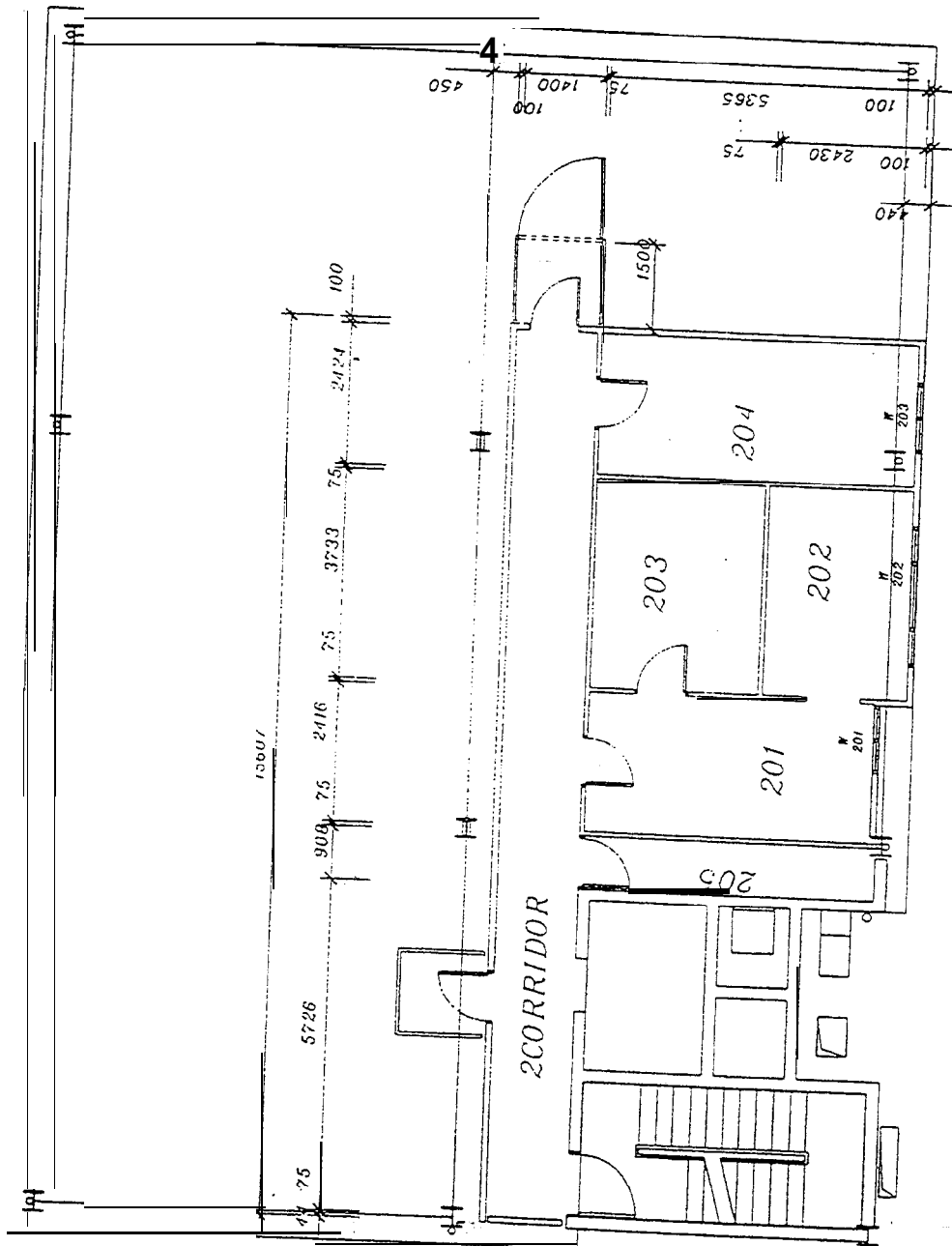

Figure 3-3 Level 2 Floor Plan

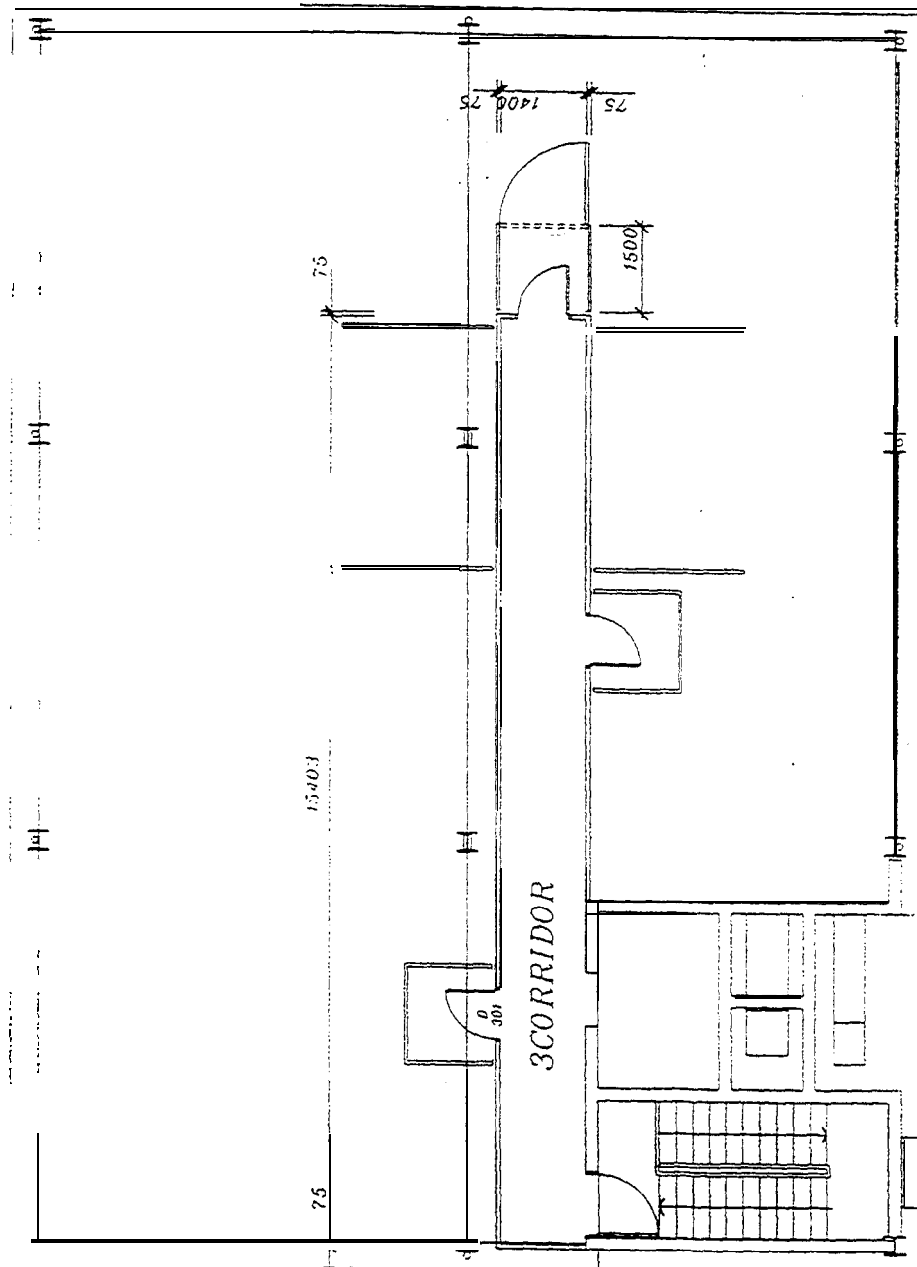

Figure 3-4 Level 3 Floor Plan

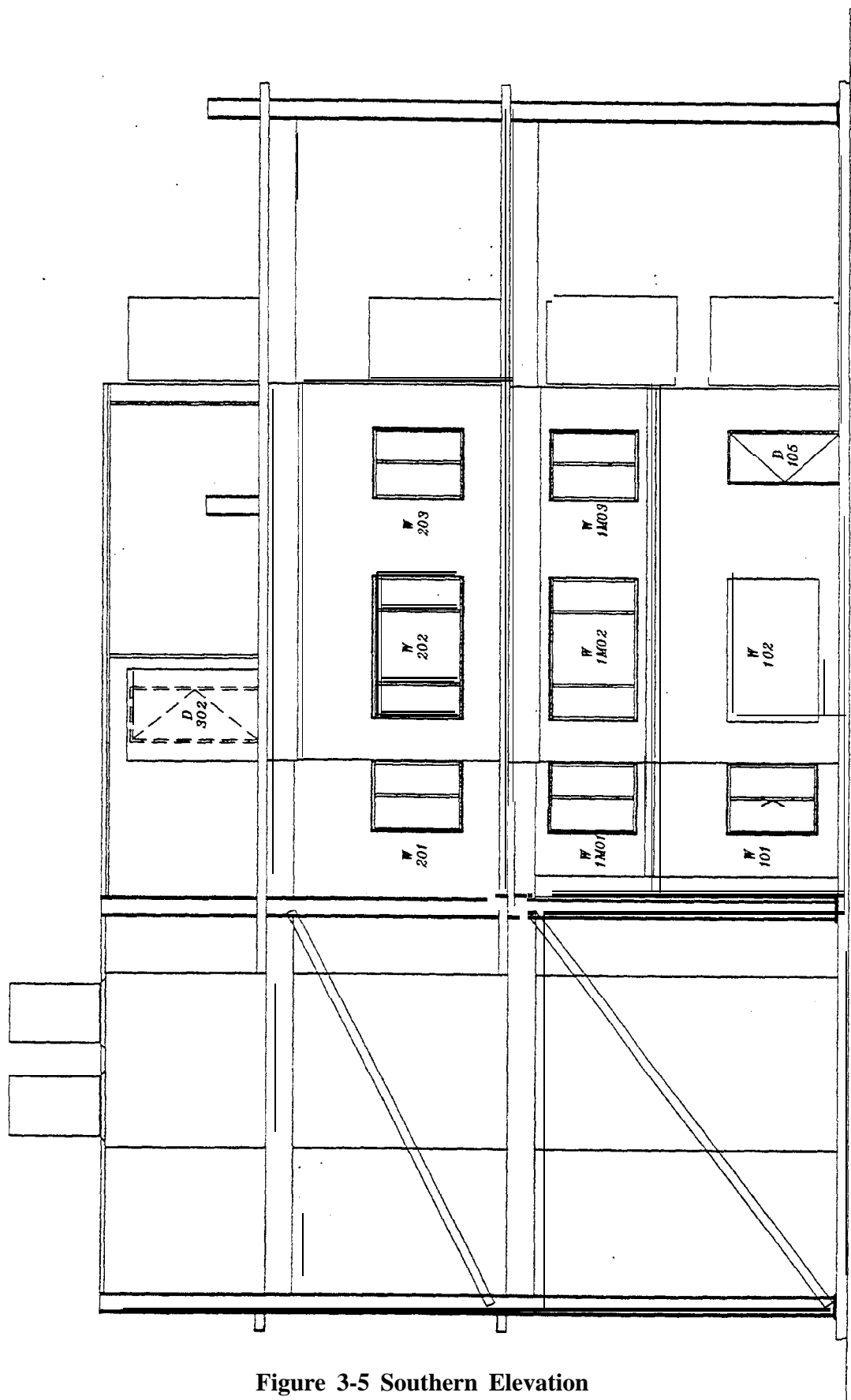

Figure 3-5 Southern Elevation

3.2 CONSTRUCTION DETAILS

3.2.1 Burn Room(s)

Room 102 on Level 1 was used as the burn room for the smouldering (SM) and small room fire experiments (FMS). Rooms 102 and 103 were then combined by removing the common wall to form a large burn room (5.4m x 3.6m) that was used for those flaming fires (FML) involving a larger fuel load (refer Figure 3.1). For the experiments involving the large burn room, the door to Rooms 101, 102 and 103 were sealed and a new door was placed centrally in the northern end of the large burn room into the corridor. Room 104 was used exclusively as the instrumentation room and was blocked off during all the experiments.

The small burn room is nominally 2.4m x 3.6m in plan as shown in Figure 3.6, and has a height of 2.4m. A single door is situated on the western wall of the room measuring 820 mm by 2040 mm high, positioned in the centre of the west wall of the room. The gap at the top of the door when it is closed is 5 mm and at the bottom it is 20 mm. Located in the floor of the burn room is a platform of a weighing assembly which is used to determine the fuel mass loss during a fire experiment (refer to Appendix A).

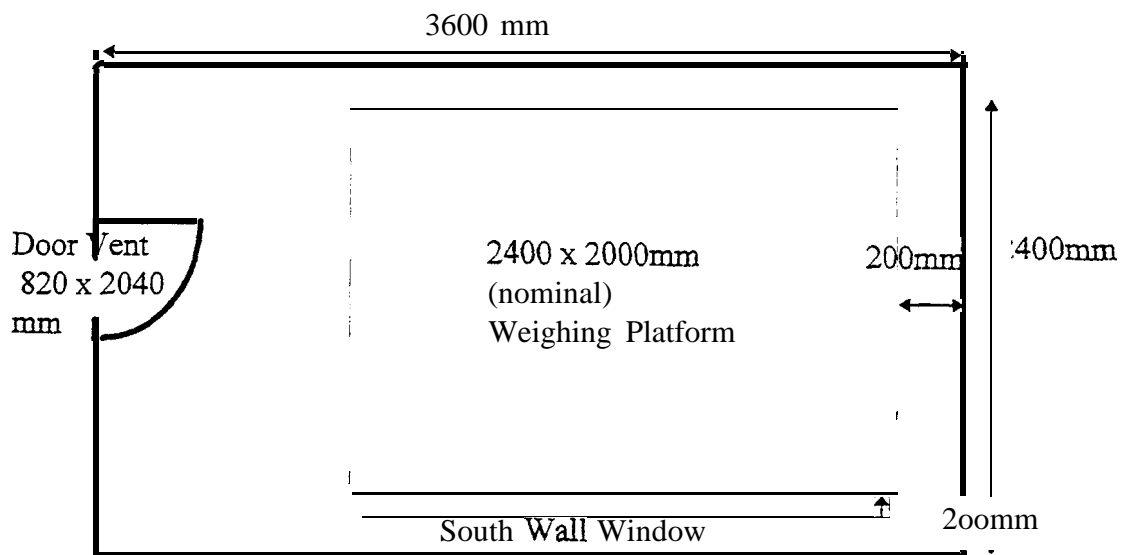

Figure 3-6 Plan View of the Burn Room (Room 102)

There is also a window to the outside situated in the centre of the south wall, 500 mm above the floor (refer to Figure 3.1). The window construction is shown in

Figure 3.7. The window is manufactured using timber reveals and consists of an all-aluminium **frame**. Two 600 mm sliders are located on each side. Standard 3 mm window glass was used in the sliding sections and 4 mm glass in the centre pane. For the larger fires four panes of 6 mm glass was used due to the greater intensity of the fires.

Room 101 also contained a sliding window which was affected by fire experimentation when using the small burn room. The window consisted of two 600 mm wide x 1500 mm deep x 3 mm thick plate glass panes; one sheet is fixed and the other sliding.

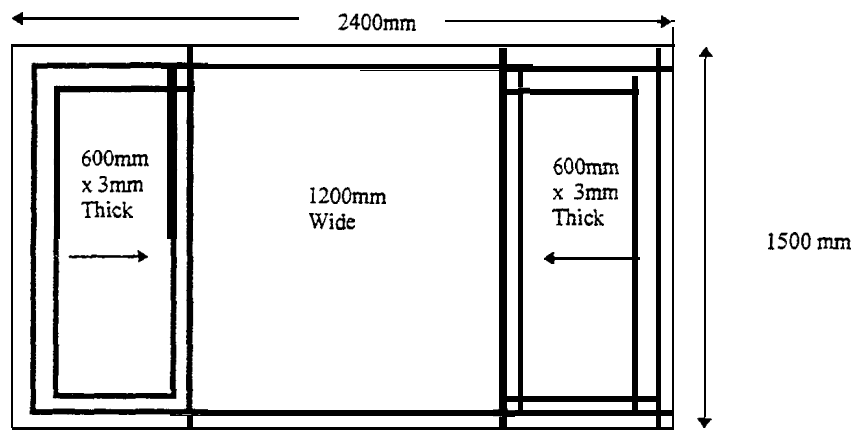

Figure 3-7 Window W102 Construction Details

The construction in both the small bum room and the southern end (above the mass loss platform) of the large burn room were modified slightly to increase the fire resistance during experimental conditions. Three layers of 16 mm fire-rated plasterboard sheeting were used on the ceiling and 2 layers on the walls.

The finished floor level of Room 102 (and partially Room 101) and the southern end of the large bum room was raised by 100 mm to cater for the weighing **platform** (see Appendix A). The false floor was constructed of cement sheets on steel joists. The construction of the floor system above the bum room (for the mezzanine Level 1M), consists of C-section **purlins** lined with tongue and groove particle board flooring. Figure 3.8 gives a interior **view of** the bum room.

Figure 3.9 is a picture of south facade of the building. The windows of Rooms 101 and 102 can be clearly seen. The veranda above the first level was removed during the fire experiments. The open door to the right leads to the instrumentation room.



Figure 3-8 Interior View of Room 102 (Burn Room) showing Mass Loss Platform



Bum Room-

Instrumentation
Room

Figure 3-9 Experimental Building-Fire Facility South Side Facade

3.2.2 Instrumentation Room

The instrumentation room, which is designated as Room 104 (refer to Figure 3.1), is located at the south east corner of the building. This room is used solely for housing instruments. It was isolated from the rest of the building during the experiment. Measured electrical signals from various instruments were collected in this room, and relayed via multiplexer boxes to a data acquisition and control room, located to the south of the building. Figure 3.10 gives an interior view of the instrumentation room.

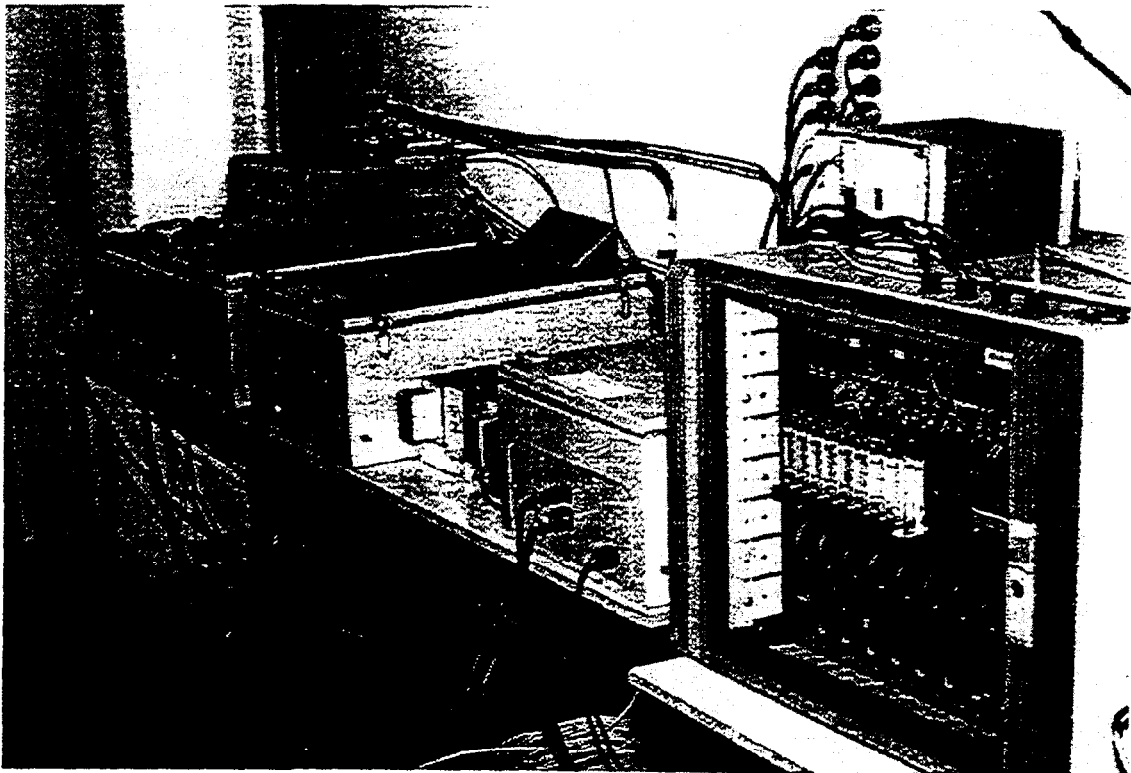

Figure 3-10 Interior View of the Instrumentation Room.

3.2.3 Smoke Management System

The Smoke Management System consisted of a stair pressurisation, smoke spill and zone pressurisation.

The stair pressurisation system was commissioned to provide a minimum air velocity through the open stair door on Level 1 of 1 m/s. The zone pressurisation system was commissioned to provide a minimum of 20 Pa pressure difference between the fire door (Level 1) and all other floors (refer to Appendix C for air flow conditions during normal air handling / conditioning mode and zone control mode).

Activation of the Smoke Management System was performed manually immediately upon activation of the high sensitivity (refer to Appendix B) photo-optical smoke detector in the return air duct. On activation of the photo-optical detector, the stair pressurisation system and the smoke spill fans were switched to high. The supply air dampers to Level 1 and the return air dampers to all other levels were closed. Also the return air damper on Level 1 was effectively opened and the supply air damper to all other levels were opened. The duration to close/open the dampers was some 2 minutes. This configuration provided a zone pressurisation to the building with Level 1 as the fire floor.

After 120 seconds activation of the photo-optical detector in the return air duct and activation of the smoke management system, the fire-rated dampers in the supply air ducts to Level 1 were also closed (triggered by an electrical signal). This was done both as a safety precaution and to represent the expected actual operation of the fire dampers.

3.2.4 Smoke and Heat Detectors

A total of six smoke detectors were used during the experimental program, 3 were of the ionisation type, and 3 were of the photo-electric type. All detectors were commercially available. Additional testing was done by Scientific Services Laboratory (Melbourne, Australia) and were found to comply with Australian Standard 3786-1993 (refer Appendix B).

Smoke detectors were located on the ceiling in the centre of Room 101 (SD01), on the ceiling in the corridor outside Door D1 (SD02), and within the return air duct (SD03) on Level 1. The detectors within the return air duct did not have a duct probe connected, but were placed directly in the return air duct.

The photo electric detector in the return air duct was used as the signal to activate the smoke management and stair pressurisation systems.

Two heat detectors (HD01 & HD02) were used for both the small room flaming fire experiments (one was located on the ceiling in the centre of Room 10 1 and the other in the corridor outside Door D1) and the large room experiments (one in the centre of the burn room and the other in the corridor outside Door D1).

A thermocouple was placed adjacent to each smoke detector.

3.2.5 Sprinkler

A sprinkler was located in the centre of the burn room for all small burn room flaming fire experiments. Two sprinkler heads were located in the centre line of the large burn room approximately 3m apart for all large burn room flaming fire experiments. In all cases, the sprinkler was fitted with a 10 mm, 68°C bulb type head.

The sprinkler system was only charged with water for two experiments, one based on a kitchen fire scenario in the small burn room (FMS3) and one large room flaming fire (FML7). The water pressure used during these two experiments was approximately 50 kPa at a flow rate of 60l/sec.

When the sprinkler sub-system was not charged with water, the fire was allowed to grow freely. The sprinkler activation time (breakage of the bulb) was recorded during both the charged and non-charged experiments.

4. INSTRUMENTATION

4.1 GENERAL LAYOUT

The EBFF is equipped with a variety of instruments for building fire research. The instrumentation used in this experimental program includes a fire igniter, thermocouples, radiometers, weigh assembly, gas analysis unit and equipment to record detector and sprinkler activation times. Detailed descriptions of these instruments together with the data logging and processing systems are given in Appendix A.

Figures 4.1 to 4.5 detail the instrumentation setup adopted for the experimental program. The symbols represent various type of instruments which are explained in the caption. The abbreviations used in those figures are the identification codes for each of the sensors and constructions is given in Table 4.1.

Table 4-1 :- Identification Codes of Instruments and Constructions.

ID code	Object
D	Door
GA	Gas analyser sampling point
HF	Heat flux meter (Radiometer)
RM	Room
SD	Smoke Detector, Optical Type
SDI	Smoke detector, Ionisation Type
HD	Heat Detector
SO	Smoke obscuration meter
SPR	Sprinkler
T/C	Thermocouple rack
VP	Velocity probe

4.2 INSTRUMENTATION LOCATION

4.2.1 Thermocouples

Thermocouples were placed in the following locations;

1. One thermocouple was placed adjacent to the sprinkler head in Room 102 for the small **burn** room experiments, and adjacent to each smoke detector, gas analysis point, and obscuration meter including those in the stairs (refer to the following sections). For the large room experiments a thermocouple was placed adjacent to each detector and sprinkler head in **the large** burn room.
2. A rack of 6 thermocouples, 230 mm apart and 700 mm off the floor level was located in Doors **D1**, **D2**, **D9**, and at the stairwell door to Level 3 (T/C01 - T/C04). For the large burn room experiments the rack from Door **D1** was placed in the door to the corridor **from** the large burn room and the rack **from** Door **D2** was removed.
3. Two racks of 10 thermocouples, 1500 mm apart, at a height of **1700** mm, were placed down the corridors on Level I and Level 3 (T/CO5 & T/CO6).

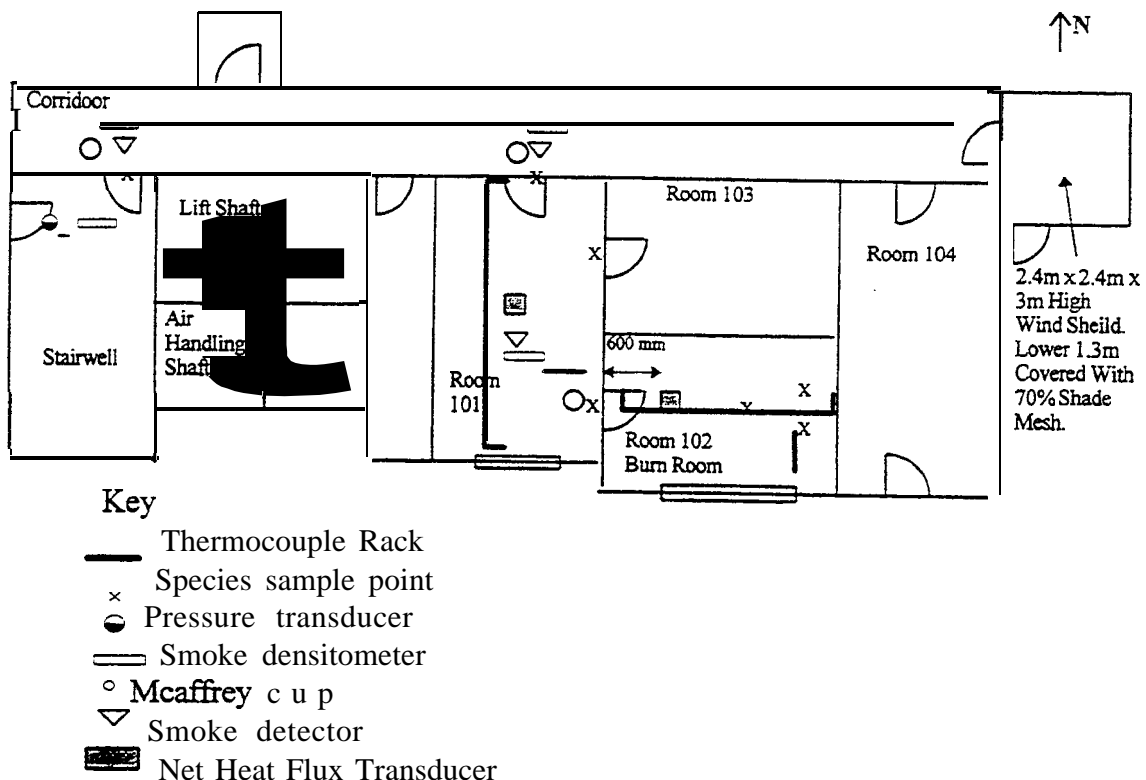

Figure 4-1 Level 1

Typical Instrumentation Location Plan -Small Room

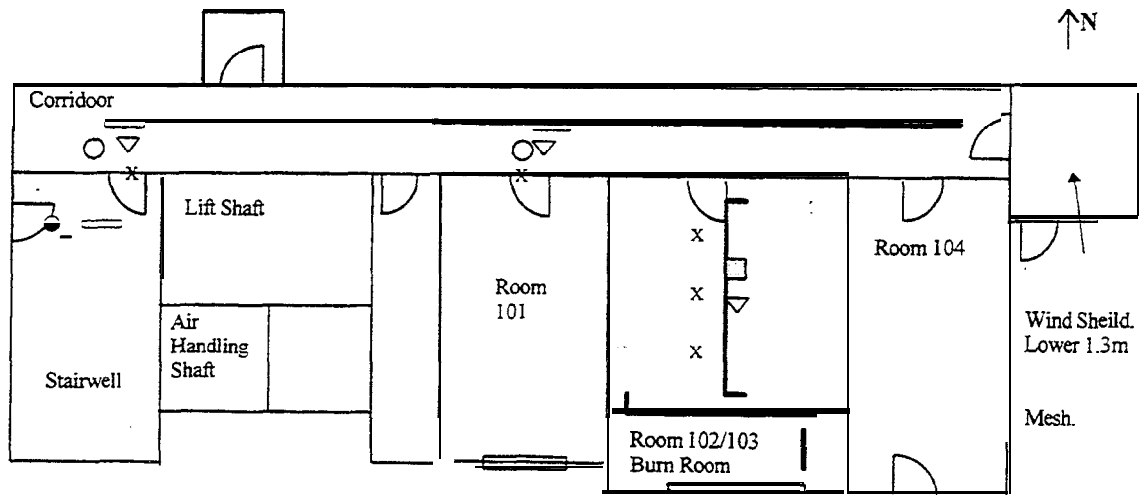

Figure 4-2 Level 1

Typical Instrumentation Location Plan - Large Room

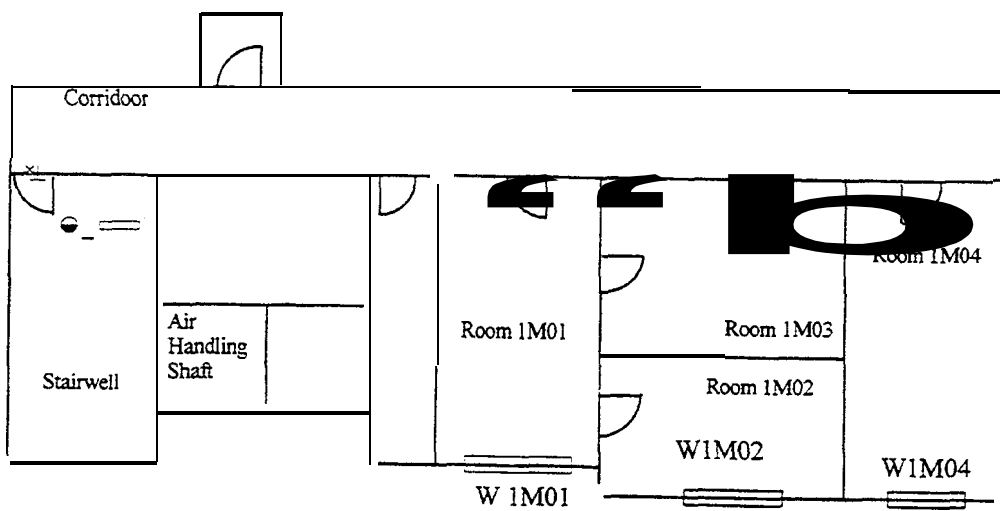
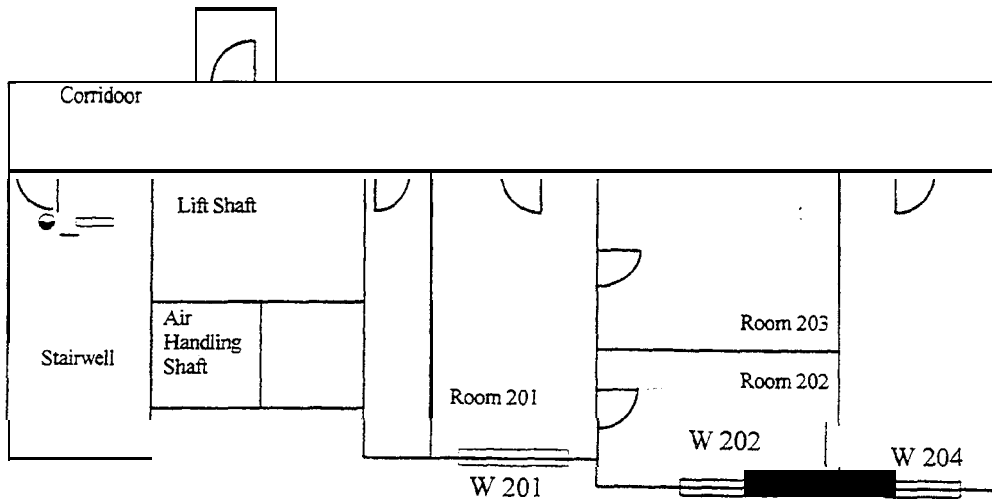
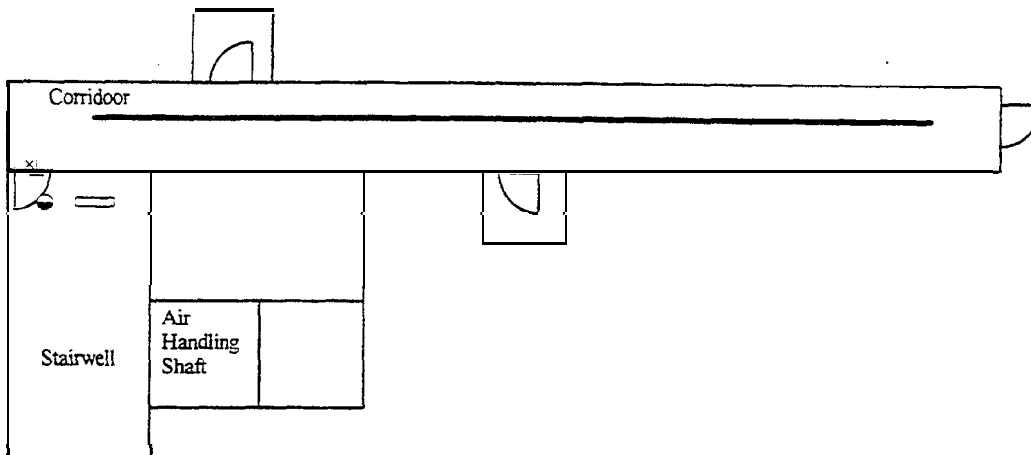

Figure 4-3 Level 1M

Typical Instrumentation Location Plan



**Figure 4-4 Level 2
Typical Instrumentation Location Plan.**



**Figure 4-5 Level 3
Typical Instrumentation Location Plan**

4. Smouldering fire experiments, which were conducted in the small room (2450 mm x 3639 mm), are designated with the prefix SM. For the smouldering (SM1-SM8) and small room flaming experiments (FMS1-FMS9), two racks were positioned in Room 102 (T/C07 & T/C8 as shown in Figures 4-6 and 4-7). Rack T/C07 was placed longitudinally down the centre of Room 102, 1200 mm from the side walls. The bottom two thermocouples on alternate vertical rods on rack T/C 07 were displaced downwards, such that they were 400 mm below the bottom line of the rack and spaced 400 mm. Rack T/C8 was placed 1300 mm from the rear wall. Both racks were hung 250 mm from the ceiling.

5. Two thermocouple racks were placed in Room 101 (T/C9 & T/C 10 as shown in Figures 4-8 and 4-9). Thermocouple rack T/C9 was positioned longitudinally down the room, 1230 mm from the side wall. Rack T/C10 was placed 800 mm from the rear wall.

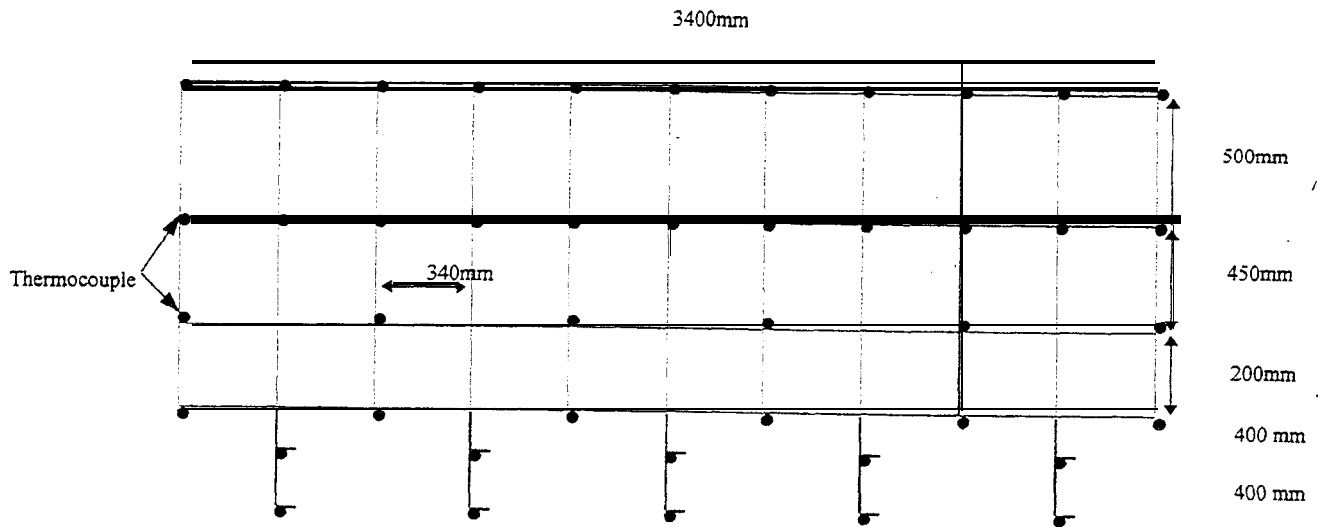

Figure 4-6 Thermocouple Rack T/C07 for Room 102

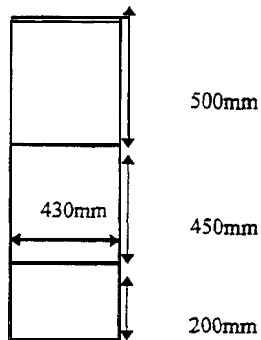

Figure 4-7 Thermocouple Rack T/C 08 for Room 102

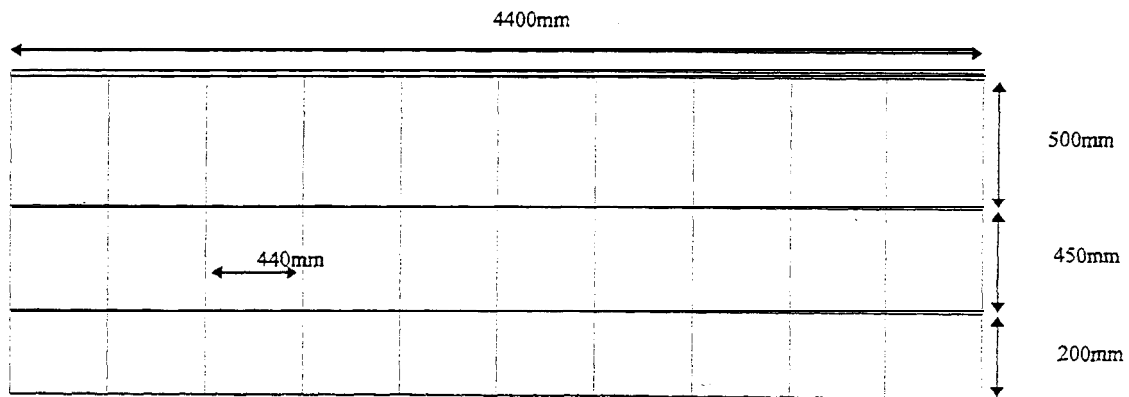

Figure 4-8 Thermocouple Rack T/C09 for Room 101

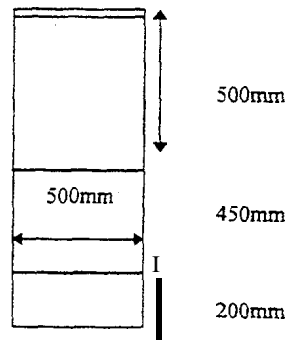

Figure 4-9 Thermocouple Rack T/C10 for Room 101

6. For the large room flaming experiments (FML1 - FML7) a thermocouple rack, T/C11 was placed longitudinally down the **centre** of the room. The rack was identical to rack T/CO7 except that it was 3900 mm long. Thermocouple racks T/C 12 and T/C 14 were used in the same positions as for the **smouldering** and **small** room flaming tests described above.

7. For the smouldering and small room flaming fire experiments, three thermocouple racks were placed in Room 103, T/C 12-T/C 14 (refer Figure 4- 10). The racks were placed in centre line of the room, 1440 mm **from** wall, at 900 mm spacing. For the large room flaming experiments, the central rack T/C13 was replaced by rack T/C11.

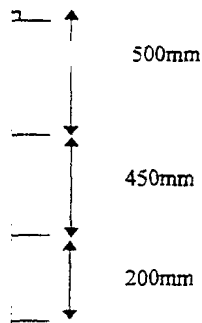

Figure 4-10 Thermocouple Racks T/C12 - T/C14 for Room 103

4.2.2 Radiometers

Heat flux transducers were used to measure radiative heat transfer during the experimental program. The heat flux transducers were of the Gardon Gauge type and used water to cool the heat sink during experiments.

Two radiometers were used during the small room flaming experiments (FMS1 - FMS9). The first radiometer HF01 was placed on the floor in Room 102, 600 mm from the Door D2. The second radiometer HF02 was placed in the centre of the floor in Room 101.

For the large room flaming experiments (FML1 - FML7) the heat flux transducer HF02 was moved to the centre of Room 103.

4.2.3 Weigh Assembly

A weigh assembly was available in the EBFF to measure the fuel mass hence enable the deduction of fuel burning rate in Room 102 during fire experiment. The assembly consisted of a platform supported by three load transfer rods to which load cells were connected to Room 1M02.

All material to be involved in the fire were placed on the weigh assembly in Room 102.

4.2.4 Chemical Analysis Unit

A custom-built gas composition analysis unit was used to provide gas analysis at four locations throughout the EBFF including the stair well, corridor, and burn room. In most cases the gas input tubes (6 mm stainless tubing) were placed in high temperature positions.

For the smouldering experiments gas analysis was performed at 6 positions:

- 1 Four analysis points (P01 - P04) located at Door D2 to the burn room 700 mm above floor and 400 mm spacing. Detectors to measure CO, CO₂, and O₂. The top most sampling point (PO 1, 1900 mm) was connected to the high sensitivity 1000 ppm CO analyser while all other CO points were connected to cells with a maximum range of 5%.
2. One analysis point (P05) was located at Door D1 into the corridor at height of 1900 mm and set to detect CO, CO₂, and O₂.
- 3 One analysis point (P06) was located at Door D9 into stair well at height 1900 mm. CO concentration was detected using a 1000 ppm analyser while the CO₂, and O₂ analysis points were connected to the portable units.
- 4 Gas analysis points were located in the centre line of the respective doors but within Rooms 102, 10 1 and the corridor such that when the Doors D2, D 1 and D9 were closed the analysis points measured the concentrations within 102, 10 1, and the corridor.

For the small room flaming fire experiment gas analysis was performed at a total of 11 positions:

1. Eight (8) analysis points were located at Door D2 to the burn room. Seven detectors were used to measure CO₂, and O₂. Two of the points were also used to measure CO using 5% cells. The eighth detector measured O₂ only.
2. Three additional analysis points were placed within the burn room to analyse O₂.
3. One portable 1000 ppm CO analyser was placed at a height of 1900 mm in the stair door (Door D9).
4. One portable 1000 ppm CO analyser was located at the door from the stair well into level 3 at a height of 1900 mm.
5. One portable 1000 ppm CO analyser was located at 1900 mm adjacent to Door D5 within the corridor.

A thermocouple was placed adjacent to each analysis point.

There are time lags associated with the response of the gas analysing unit which have not been taken into account in the data processing. The time for the output signal to reach 50% of the input level, for a step input (T_{50}), was determined for the gas sensors used in an earlier series of fire tests, as described by Beck et al., 1995. Those results gave a mean T_{50} response time for the 12 tests (4 gas channels each

tested with CO₂, CO and O₂), of 55 seconds, with a standard deviation of 20 seconds (Reference 2).

4.2.5 Smoke Obscuration

Smoke obscuration measurements, using Aeronautical Maritime Research Laboratories (AMRL) infra red densitometer equipment, were recorded at eight locations detailed below:

1. One densitometer adjacent to smoke detector in Room 10 1
 2. One densitometer adjacent to gas analysis point at Door D 1.
 3. Two densitometers on each side of Door D9.
 4. 3 densitometers along the centre line of the stair shaft at the elevation of Levels 1M, 2, and 3.
 5. One densitometer within the return air shaft adjacent to the smoke detector.
- A thermocouple was placed adjacent to each densitometer.

4.2.6 Video Recording

Video recording equipment was used for the experimental program and consisted of 8 fixed cameras located in the following locations:

1. 1 camera at Level 1 services room looking into Room 10 1 and Room 102
2. 1 camera within Level 1 corridor looking towards an EXIT sign
3. 1 camera located outside window into Room 102.

All camera outputs were recorded on video tape.

4.2.7 Pressure Measurements

Pressure from Levels 1, 1M and 2 were measured with differential pressure gauges located within the stairwell at Levels 1, 1 M and 2, such that the pressure difference between these levels was recorded.

The smoke management sub-system was commissioned before the experiments were conducted . Firstly, the sub-system was commissioned such that the pressure difference between Level 1 and Levels 1M, 2 and 3, was 20 Pa with all the stair doors closed. Secondly the sub-system was also commissioned when the stairs to level 1 was open, to provide a velocity of at least 1m/s through the open stair door (refer Experimental Report, Appendix C).

4.2.8 Velocity Measurement

For the smouldering experiments velocity measurements were performed using 6 McCaffery cups at the following locations:

1. 4 McCaffery cups (V01 -V04). Measurements were taken at Door D2 adjacent to the gas analysis points at 700 mm above floor and 350 mm spacing.
2. 2 McCaffery cups (V05 -V06). Measurements were taken at Door D9 at 700 mm and 1900mm.

During experiments involving smoke management the velocity of air flow from the stair into level 1 was maintained at not less than 1 ms^{-1} .

Velocity measurement during the flaming fire experiments were performed using 14X McCaffery cups at the following locations:

1. 8 McCaffery cups: measurements were taken at Door D2 adjacent to the gas analysis points.
2. 1 McCaffery cup: measurement at the Door D 1 at 1000 mm above the floor.
3. 4 McCaffery cups: measurement points at the stair door (Door D9). The measurement points were taken at 500 mm above the floor and 350 mm spacing.

During experiments involving smoke management the velocity of air flow from the stair into Level 1 was maintained at not less than 1 ms^{-1} .

A thermocouple was placed adjacent to each velocity probe.

4.2.9 Weather Condition Monitor

The ambient conditions were measured before, during and after all experiments using a weather station.

5. EXPERIMENTAL PROGRAM

5.1 FIRE STATISTICS

In order to ensure that the experiments conducted at the EBFF, Fiskville represented fire scenarios likely to occur within an apartment **building**, a review of the available statistics has been performed (refer Appendix D for Tables of Statistics used in the study).

The Australian fire statistics as compiled by the CSIRO do not use the same building classification scheme as in the BCA, but rather separate buildings in terms of their use such as 1&2 family dwellings, guest house, apartments. For the purposes of this study the following building descriptions from the fire statistics were grouped as class 2 - 4 buildings:

1. Apartments, tenements, flats
2. Rooming, boarding, lodging houses
3. Hotels, motels, inns, lodges
4. Dormitories
5. Home hotels, self contained units

The relative frequency of the different compartments of fire origin, ignition factors, equipment involved, materials initially ignited and the form of material initially ignited, for class 1 and class 2 - 4 buildings for each time period, obtained **from** the CSIRO statistics for the period 1988 - 1992 are as shown below (Reference 1).

1. Most common area of fire ignition in descending order:

- Kitchen (35.1%)
- Bedroom (15.8%)
- Lounge (7.8%)

2. The most common ignition factors in descending order:

- Unattended (18.4%)
- Discarded material (13.3%)
- Short circuit (8.1%)

3. Equipment involved in descending order:

- Fixed cooking surface (21.7%)
- Fixed oven (3.4%)
- Portable heating unit (2.9%)
- Fixed heating, washing machine (1.4%)

4. Material ignited first in descending order:

- Cooking materials (26.4%)
- Rubbish (14.7%)
- Wire insulation (11.5%)
- Mattress, pillow, bedding (9.6%)

5. Material ignited first in descending order:

- Fat/grease (18.3%)
- Plastics (15%)
- Paper (12.1%)

No information was provided in relation to the extent of fire spread and the associated ignition scenario or the proportion of each type of fire.

Information obtained from the National Fire Protection Association, USA (NFPA, Reference 3) regarding fires within hotels and motels between 1988 and 1992 indicated that smoking and incendiary fires accounted for almost two of every five fires. The statistics also indicated that although cooking equipment accounted for 13.4% of fires they only accounted for 6.8% of property damage suggesting that they did not spread to any great extent. Smoking materials accounted for 19.4% of fires but only 9.3% of property damage, also suggesting that they did not generally develop beyond the smouldering stage. Apart from incendiary fires the ignition scenarios that caused the greatest amount of damage were those involving heating equipment (9.0% fires, 14.2% property damage).

With regard apartment fires the major causes of fires were cooking equipment (34.7%), incendiary fires (15.4%), smoking materials (10.2%), and heating appliances (5.4%). In terms of property damage cooking equipment accounted for 11.1%, while smoking and heating appliances accounted for 9.2% and 5.6% respectively. Cooking equipment did not cause a proportional amount of property damage with respect to the number of fires again suggesting that they do not spread to any great extent. In terms of area of origin for apartment fires the NFPA figures were similar to those from Australia in that the major area of origin was located within the kitchen (43.7%) followed by bedrooms (15.1%) and lounge rooms (8.5%). Although kitchens were the leading area of origin fires originating in the kitchen were only third with respect to property damage. This again suggested that the fires did not spread to any great degree.

One reason for the above could be seen in the number of deaths and injuries caused by the fires in apartments. Fires originating in the kitchen accounted for only 13.3% of deaths but accounted for 32.4% of injuries. On the other hand living room fires accounted for 33.5% of deaths and 18.7% of injuries.

The above suggested that kitchen fires occurred while the occupants were alert and were of size that could be fought by the occupants at the time of detection. Living room fires appeared to spread further **and/or** be of a size that a person would be more likely to overcome rather than injured.

5.2 FIRE EXPERIMENTS

Based on the above statistics one ignition scenario used in this project was based on a kitchen setting. However, given the types of materials initially ignited (cooking fats and oils) and the power output of the ignition sources it was considered that flaming fires would be more likely to occur within the kitchen than smouldering fires. The above statistics further suggest that the kitchen fires do not tend to go to flashover.

With regard smouldering fires it was considered that they would be most likely to occur in association with bedding **and/or** lounge furniture and to be **ignited** by smoking.

Supplementary experiments involving ignition of commercially available fuel loads and real ignition sources for example cigarettes and heaters, were performed to serve as a comparison between the time to ignition for the real scenarios and those methods used in the experiments.

Smouldering fire experiments, which were conducted in the small room (2450mm x 3639 mm) are **designated** with the prefix SM. Supplementary experiments involving ignition of commercially available fuel loads and **real** ignition sources for example cigarettes and heaters, were performed to serve as a comparison between the time to ignition for the real scenarios and those methods used in the experiments.

The flaming fires were conducted in a small room (2430 mm x 3639 mm, see Section 3.2), and a large room (5390 mm x 3639 mm). **Non-flashover** flaming fire experiments conducted in the small room are designated with the **prefix** FMS and those conducted in the large room the prefix FML.

Each experiment was conducted such that all the **fuel** load was centrally located on the weight **platform**. The simulated chair and the commercially available chair were placed on the platform with the back facing the window and the base facing the door. The simulated three seater couch and the commercially available three seater couch was placed on the platform with the base facing the window and the back facing the door.

5.2.1 Smouldering Fires

5.2.1.1 Commercial Product Experiments

Three smouldering fire experiments were conducted on commercially available furniture items. The aim of the commercial product experiments was to determine if the simulated furniture provided levels of smoke and toxic gases which are similar to the equivalent levels measured during the smouldering combustion of commercially available furniture items.

The comparison between the various furniture items was made in terms of the mass loss, CO concentrations, and temperatures generated. All commercial product experiments were performed with the burn room door (Door D2) open, and the apartment door (Door D1) closed and no air handling.

The commercially available furniture items and the simulated furniture items used in the comparison are listed below;

1. Single bed inner spring mattress with latex foam rubber pillow
2. Single bed polyurethane mattress with a cotton cover and latex foam rubber pillow
3. Lounge chair with cotton covering
4. Simulated polyurethane mattress using polyurethane foam slab and cotton/linen cover and a latex foam rubber pillow
5. Simulated lounge chair with cotton **linen** cover (refer Figure 5.2)

Details of the materials of construction of each furniture item are provided in Appendix E.

The experiments using the commercial products were performed using either a standard cigarette or an electric igniter. A standard cigarette ignition source was placed under the front edge of the latex foam rubber pillow for the experiments involving a mattress and pillow. An **electric** igniter, placed at the join between the seat and back cushions, was used as the ignition source for those experiments involving a chair arrangement.

5.2.1.2 Fire Simulation Experiments

Eight smouldering fire experiments, denoted as **SM1 - SMS**, were conducted using simulated furniture (refer Figure 5.2). The fuel load configurations were the same for the eight experiments but the ventilation conditions were altered for each experiment as shown in Table 5-1 and shown diagrammatically in Figure 5-1. The instrumentation arrangement is described in Section 4.

A simulated chair was chosen as the fuel load due to the greater repeatability obtained with the chair compared to a simulated mattress and the more severe conditions produced by the chair.

The eight experiments were designed to simulate smouldering of a single seat chair due to a point **source** such as a cigarette.

The simulated chair set up consisted of two and a half polyurethane foam slabs **covered** with cotton - linen material (40% cotton - 60% linen) **mounted** on a steel **frame**. The dimensions of the single polyurethane slab for the seat were 560 x 560 x 100 mm. The dimensions of the rear cushion were 560 x 787 x 100 mm (refer Figure 5-1 and Figure 5-2). Details of the simulated lounge chair are given in Appendix E.

The ignition source for all the simulation experiments was an electric igniter based on the design by Dr. G. C. **Ramsay** and A. P. Cerra (Reference 4), for igniting smouldering, upholstery fires. Current to the igniter was set at a current of 12 amps. The ignition was placed in the join between the cushions on the seat and back rest of the chair (refer Figure 5.1).

Table 5-1 Door and Ventilation Conditions for the Smouldering Fire Experiments

Experiment ID	D1	D2 (Burn Room)	D3	D5	D9	Lift	STAIR PRESS'N /SMOKE MANAGMENT
SM1	Closed	Closed	Open	Closed	Closed	Closed	No
SM.2	Closed	Closed	Open	Closed	Closed	Closed	Yes
SM3	Closed	Open	Open	Closed	Closed	Closed	No
SM4	Closed	Open	Open	Closed	Closed	Closed	Yes
SM5	Open	Open	Open	Closed	Closed	Closed	No
SM6	Open	Open	Open	Closed	Closed	Closed	Yes
SM7	Open	Open	Open	Closed	Open	Closed	No
SM8	Open	Open	Open	Closed	Open	Closed	Yes

Chair Fuel Load Carrier:
 570 mmi wide
 Steel 25 mm SHS frame with steel mesh infill.
 Polyurethane foam (560 x 560 x 100 mm) &
 60% linen, 40% cotton material coverings ussed as fuel load.

Note: The back of the single chair is made up of 1 & 1/2 slabs of foam

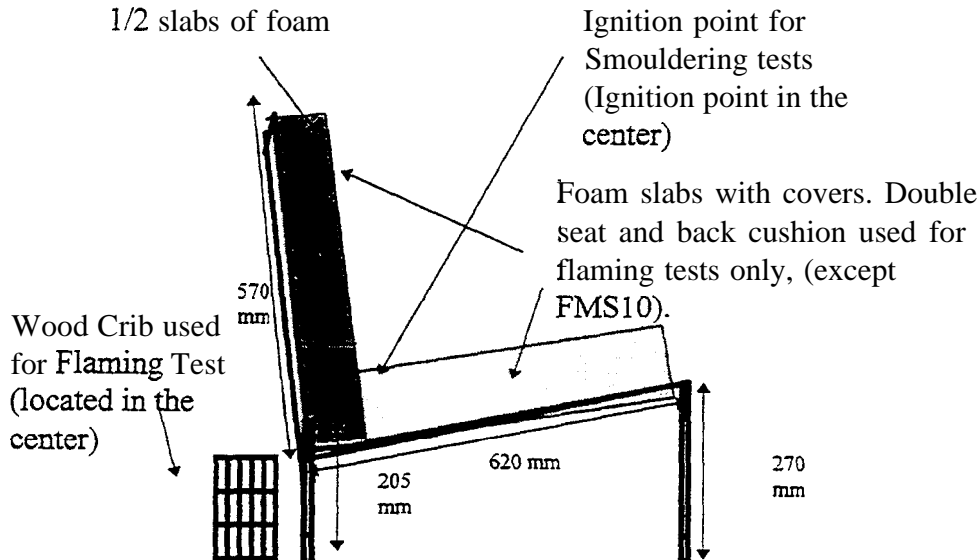

Figure 5-1 Chair Fuel Load for Smouldering and Small Room Flaming Experiments

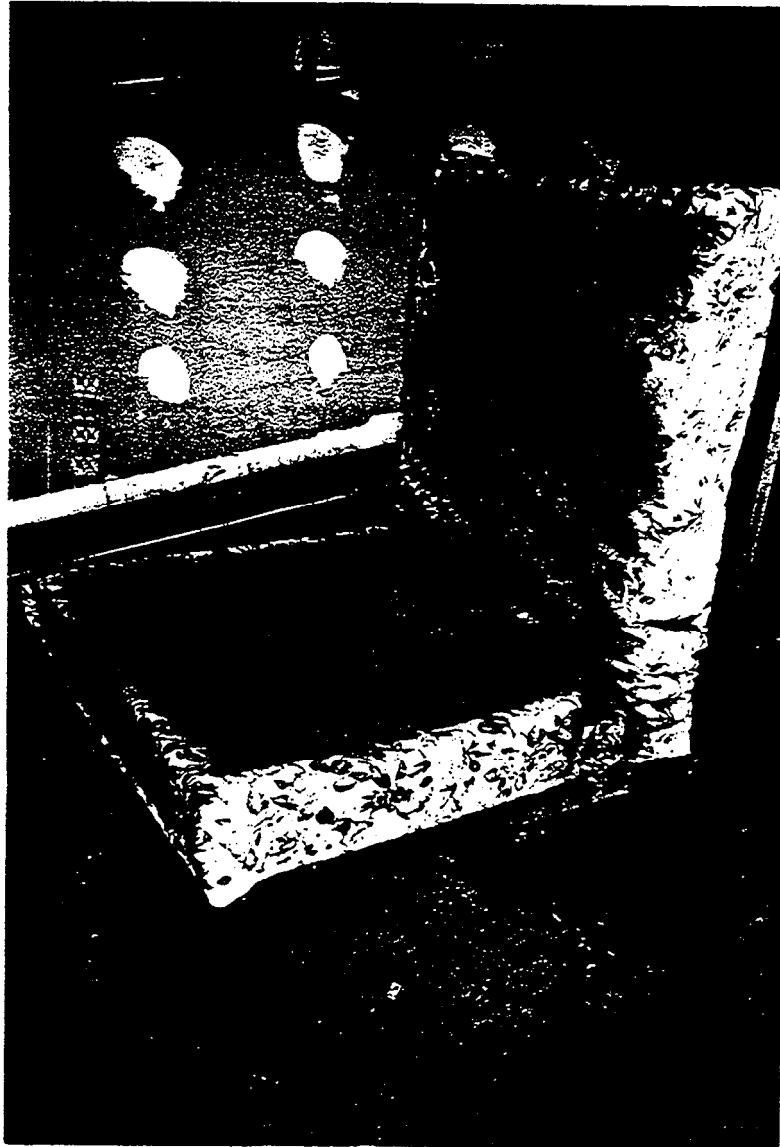

Figure 5-2 Chair used in Smouldering Fire Experiment

5.2.2 Small Room Flaming Fires

5.2.2.1 Commercial Product Experiments

Flaming fire experiments were performed in the small burn room using a commercially available arm chair and a simulated chair using four cushions on the seat, (two on the back and on the base). Details of the materials of construction of the arm chair are provided in Appendix E.

The ignition of the chairs in the experiment was accomplished using a cotton towel draped over the back of the chairs and ignited at the base of the towel using a match. This form of ignition was used to simulate ignition of a towel due to being placed too close to a heat source such as a heater.

All the commercial product experiments were performed with the burn room door (Door D2) open and the apartment door (Door D1) closed with no mechanical ventilation active during the experiment.

5.2.2.2 Fire Simulation Experiments

Nine flaming non-flashover fire experiments were performed within the small burn room, denoted as FMS1 - FMS8 and FMS10 (refer Table 5-2).

The first three experiments (FMS1 - FMS3) were based on a mock up kitchen scenario as shown in Figures 5-5 and 5-6. The fuel load for the kitchen fire experiments consisted of 1.84 kg of vegetable oil in a 30 cm diameter pot placed over a gas ring burner (refer Appendix E).

Experiments FMS4 - FMS8 and FMS10 were performed using a simulated chair which consisted of cushions on the seat and rear portions of the chair as shown in Figure 5.1 and 5.2. Ignition of the chairs was achieved using a 150gm crib located as shown in Figure 5.1.

The chair set up consisted of five polyurethane foam slabs (3 on the back and two on the base; note that the back of the single chair is made up of one and a half polyurethane slabs so doubled this gives a total of 3 slabs) covered with cotton - linen material (40% cotton - 60% linen) for both the seat and the rear cushions mounted on a steel **frame**. The dimensions of the polyurethane slabs for the seat were 560 x 560 x 100 mm. The dimensions of the rear cushion were 560 x 787 x 100 mm (refer Figure 5-1). The only exception to this configuration was experiment FMS10 where single slabs were used for both the seat and rear cushions. The grade of polyurethane was the same as was used during the smouldering fire experiments. Details of the simulated lounge chair are given in Appendix E.

The fuel load configurations were kept constant for each of the three kitchen fire experiments and six chair experiments, but the ventilation conditions were altered for each experiment as shown in Table 5-2. The instrumentation arrangement is described in Section 4.

Table 5-2: Small Room Flaming Fire Ventilation Conditions

EXPERIMENT ID	D1	D2 (Burn Room)	D3	D5	D9	Lift	Sprinkler	STAIR PRESS'N /SMOKE MANAGMENT
FMS 1	Open	Open	Open	Closed	Closed	Closed	No	No
FMS2	Open	Open	Open	Closed	Closed	Closed	No	Yes
FMS3	Open	Open	Open	Closed	Closed	Closed	Yes	NO
FMS4	Closed	Closed	Open	Closed	Closed	Closed	No	No
FMS5	Closed	Closed	Open	Closed	Closed	Closed	No	Yes
FMS6	Closed	Open	Open	Closed	Closed	Closed	No	No
FMS7	Closed	Open	Open	Closed	Closed	Closed	No	Yes
FMS8	Open	Open	Open	Closed	Closed	Closed	No	No
FMS10	O p e n	Open	Open	Closed	Open	Closed	No	No

FMS1 - FMS3 : KITCHEN EXPERIMENTS. These experiments were based on the ignition scenario of a pre-heated pot of chip pan oil that subsequently ignites an overhead particle board shelf assembly (refer Figures 5.3, 5.4, and 5.5).

The oil was heated using a gas burner O-ring connected to an LPG gas bottle. The ignition source was a pilot flame placed immediately above the pre-heated pot of oil. In the experiments a piloted ignition source was used, where as in a real scenario ignition will either be as a result of boiling over of the oil or non-piloted ignition. A pilot ignition source was used to reduce the time to ignition and increase the repeatability of the experiments.

FMS4 - FMS10 : LOUNGE ROOM EXPERIMENTS. The ignition scenario that was simulated was that of a towel placed on back of upright single lounge seat that is placed too close to heater. This simulates drying of wet clothes while unattended, using a portable heating unit. The simulated chair that was used as the fuel load was similar to that used in the smouldering experiments. (Refer to Figure 5.1). For reproducibility and due to the relatively small fuel load represented by the towel, a towel was not used in the experiments. The ignition source was a 150g wood crib placed on the floor behind the chair (refer Figure 5-1).

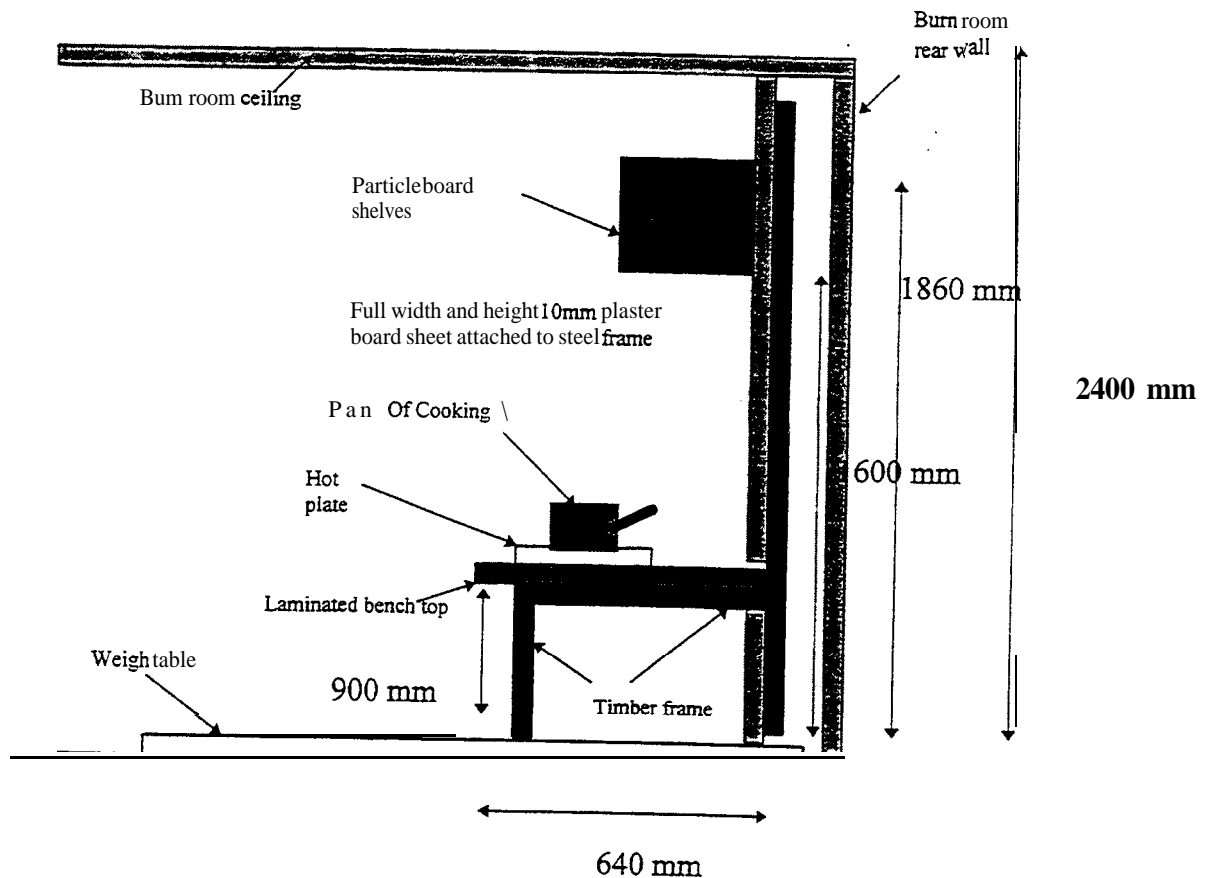

Figure 5-3: Cross section view of Kitchen Mock up used in Small Room Flaming Fire Experiments

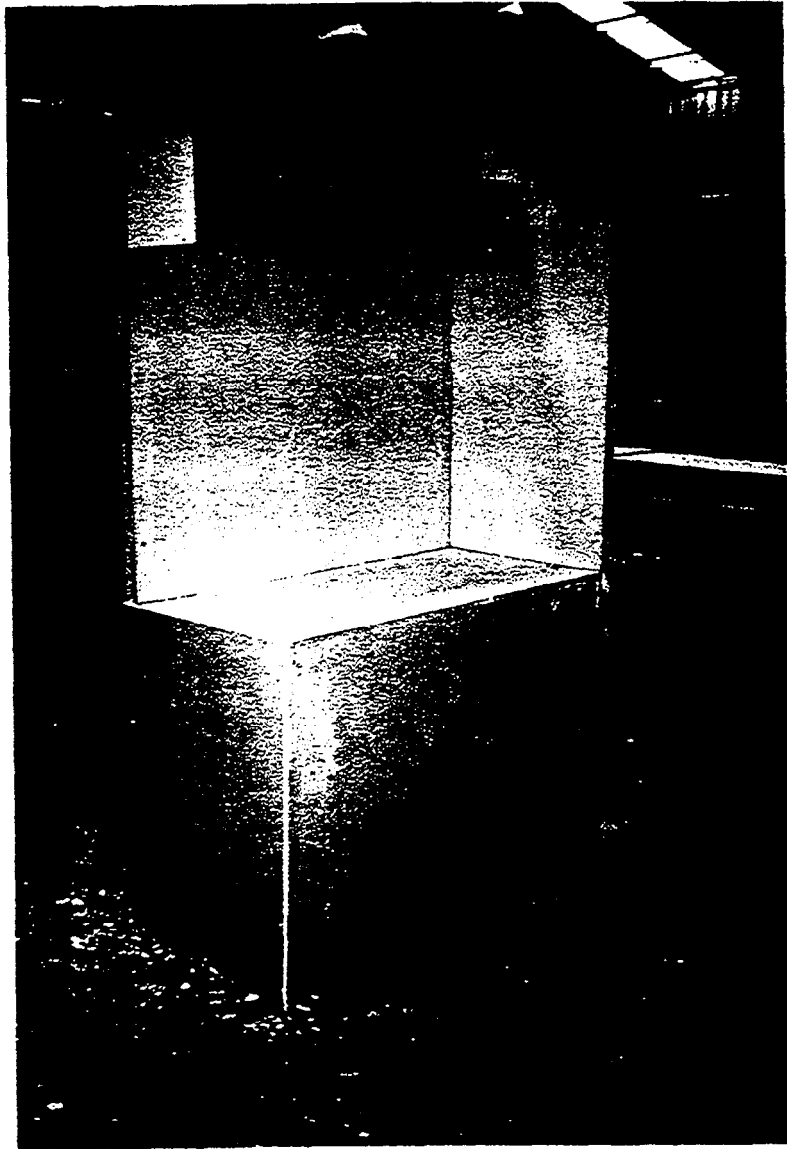

Figure 5-4: Photograph of Mock-up Kitchen used in the Small Room Fire Experiments



Figure 5-5: Kitchen Mock-up with Pot in Place

5.2.3 Large Room Flaming Fire Experiments

5.2.3.1 Commercial Product Experiments

Flaming fire experiments were performed in the large-size burn room using a commercially available lounge suite, a double inner spring mattress and base plus bedding, and a double polyurethane mattress plus bedding. Details of the materials of construction of the commercial products are provided in Appendix E.

Ignition was achieved using a 100g crib placed on the floor at the front of the centre cushion of the couch. This form of ignition was used to simulate either ignition of a waste paper basket by a cigarette on the suite being placed too close to a heat source such as a heater. It was considered that the crib would produce a more reproducible ignition source than a waste paper basket. The experiments associated with the mattress arrangements were ignited using a 100g wood crib placed in line with the edge of the mattress mid way along the side closest to the window.

All the product experiments were performed with the burn room door (Door D2) open and the stair door (Door D9) closed with no mechanical ventilation active during the experiment.

5.2.3.2 Fire Simulation Experiments

FML1 - FML7. These experiments simulate the ignition of a three seater couch due to a cigarette placed in a waste paper basket adjacent to the couch. A couch was used to provide a greater fuel load within the larger burn room and hence a more severe fire. The simulated three-seater couch configuration was **similar** to that shown in Figure 5.2 (Chair Fuel Load for Smouldering and Small Room Flaming Experiments) except that 9 slabs of polyurethane were used (3 on the back and 6 on the base).

The **ignition** source for the fire experiments was a 100g wood crib placed on the floor at the front of the centre cushion of the couch. The material for the simulated couch was similar to that from which the commercial couch was manufactured except for the timber **frame**. Details of the fuel load for the simulated 3-seater couch used in each experiment are shown in Appendix E.

The fuel load configurations were the same for the eight experiments but the ventilation conditions were altered for each experiment as shown in Table 5-3. The instrumentation arrangement is described in Section 4.

Table 5-3: Large Room Flaming Fire Ventilation Conditions.

Experiment ID	Bum Room Door Into Corridor	D9	Lift	Sprinklers	STAIR PRESS'N/SMOKE MANAGEMENT
FML1	Closed	Closed	Closed	No	No
FML2	Closed	Closed	Closed	No	Yes
FML3	Open	Closed	Closed	No	No
FML4	Open	Closed	Closed	No	Yes
FML5	Open	Open	Closed	No	No
FML6	Open	Open	Closed	No	Yes
FML7	Open	Closed	Closed	Yes	No

6. RESULTS OF SMOULDERING FIRE EXPERIMENTAL PROGRAM

6.1 COMMERCIAL PRODUCT EXPERIMENTS

6.1.1 Mass Loss

Comparison of the mass loss during smouldering -for the commercially available furniture and the simulated chair under the same ventilation conditions (refer Figure 6.1. 1-1), indicates the following significant points :

1. The mass loss for both the commercially available inner spring mattress and the commercial polyurethane mattress plus latex foam rubber pillows showed a rapid initial loss in mass due to the rapid smouldering of the pillow and the polyurethane below the pillow. The rate of mass loss then dropped once the pillow had been consumed due to the slower rate of smouldering horizontally across the mattress. The mass loss for the, polyurethane **mattress** increased towards the end of the experiment until it transformed into flaming combustion at approximately 1.5 hours.
2. The mass loss rate for the commercially available inner spring mattress became reasonably constant once the pillow had been consumed. Smouldering during this stage associated with the felt ticking around the springs rather than the polyurethane. Smouldering of the mattress continued for approximately 7 hours.
3. The simulated chair yielded a mass loss rate which was approximately equal to the mass loss for the inner spring mattress. The simulated mattress yielded the slowest rate of mass **loss**.

6.1.2 Carbon Monoxide Concentration

The carbon dioxide concentration measured at the top of the burn room door for the commercial product experiments and the simulated chair are shown in Figure 6.1.2-1.

The significant results obtained were :

1. The highest CO concentrations were initially obtained **in** association with the commercially available chair and the simulated chair. The concentration of CO associated with the polyurethane mattress increased after 1.5 hours due to the rapid increase in smouldering rate prior to transformation into flaming combustion.

2. None of the experiments conducted produced untenable conditions during smouldering on the basis of untenability at the dosage of 4 %min CO.

6.1.3 Visual Observations

The following events were noted during visual observation of the product experiments :

1. Smouldering ignition of the latex foam rubber pillow and mattress using a standard cigarette was easily achieved and was reasonably reproducible.
2. The pillow began to smoulder vertically up the front face of the pillow and then across the top face prior to any horizontal spread across the front face.
3. Once the pillow had become fully involved the pillow would sink down into the mattress, due the combustion of the mattress below the pillow, prior to any significant horizontal spread across the surface of the mattresses.
4. Vertical spread up the front face of the chairs and horizontally through the rear cushion was more rapid than horizontal spread across the face of the cushions.
5. Transformation into flaming combustion of the chairs appeared to occur once the smouldering zone had penetrated to the rear and base of the rear cushion.

6.1.4 Summary

On the basis of the results presented herein it was decided to choose the simulated chair for subsequent experiments involving smouldering fires. The simulated chair did not undergo transition into flaming combustion, as did two experiments (commercial single bed and commercial chair). The simulated chair tended to give an upper bound result for both mass loss and CO concentration compared with those experiments which did not go into flaming combustion (single bed, inner spring mattress and simulated single bed).

6.2

EXPERIMENTS

6.2.1 Mass Loss

The mass loss for the eight smouldering fire simulation experiments, SM1 - SM8, are shown in Figures 6.2.1-1 to 6.2.1-8.

The rapid loss of mass within the first 600 seconds of some of the experiments was due to the application of the electrical igniter. The rate of smouldering levelled off for a period of time after the igniter was removed.

Examination of the mass loss from each experiment indicated the following results:

1. The activation of the air handling system produced a more rapid rate of smouldering with the exception of experiments SM2 and SM8.
2. All the experiments showed a marked increase in smouldering rate at approximately 1500 seconds. This was generally associated with the propagation of the combustion zone to the rear face of the rear cushion and hence a possible increase in the degree of ventilation to the smouldering zone.
3. Many of the experiments transformed into flaming combustion, hence the difference in the durations of each experiment. The transition to flaming combustion appeared arbitrary and not to be affected by the air handling or smoke control systems.

The experiments that transformed into flaming combustion were SM1, SM3, SM4 and SM6.

4. The use of the air handling/smoke management did not appear to significantly effect the development of the smouldering fires as can be seen from the similarity in the results for all experiments.
5. The degree of natural ventilation (in terms of the door positions) did not appear to effect the rate of smouldering.

6.2.2 Average Room Temperatures

The average room temperatures within the burn room (Room 102) and the apartment room (Room 101) and the corridor are shown in Figures 6.2.2- 1 to 6.2.2-8, Figures 6.2.2-9 to 6.2.2-16 and 6.2.2-17 to 6.2.2-24 respectively. These average room temperatures were obtained by taking the unweighted spatial average of all the thermocouples in the burn room.

The greatest temperature rise of approximately 8 °C was recorded within the burn room with the burn room door closed. The temperatures within the burn room for all other experiments did not rise by more than 5 °C.

The temperatures within Room 101 and the corridor did not vary significantly during the experiments.

Untenability due to temperature was not achieved during any of the smouldering experiments.

6.2.3 Carbon Monoxide Concentration

The carbon monoxide concentrations recorded at a height of 1900 mm within the burn room door (Door D2) and the door into Room 101 from the corridor (Door D1) are shown in Figures 6.2.3-1 to 6.2.3-8.

The following significant results were obtained from the experiment:-

1. For the smouldering fires the levels of CO at the top of the burn room door reached values greater than 0.3 % only with the burn room door closed. During all other smouldering experiments the levels of CO were 0.05 % or below in all doorways.
2. During the period that the smoke control system was activated, the levels of CO were kept below 0.02% including within the burn room. When the burn room door was closed smoke was observed to be extracted from below the door and around the edges of door.
3. It appears that untenability due to CO was only achieved in the burn room with the burn room door closed using a limit of 4 % min or 0.06 % hr.

6.2.4 Oxygen Concentration

The oxygen concentration at various heights within the burn room door (Door D2) for smouldering simulation experiments SM1 to SM7 is shown in Figures 6.2.4-1 to Figure 6.2.4-7.

The only experiment to indicate any appreciable oxygen depletion was experiment SM1 with the burn room door closed that reduced the oxygen concentration by approximately 1 %.

6.2.5 Carbon Dioxide Concentration

The Carbon Dioxide concentrations detected at various heights within the burn room door were as shown in Figures 6.2.5-1 to 6.2.5-7.

The results indicated that with the burn room door closed (SM1) no stratification in the CO₂ concentration was detectable with or without the air handling system operating (Figures 6.2.5-1 and 6.2.5-2). However, with the burn room door open some stratification of the CO₂ concentration and hence the smoke density was detectable.

6.2.6 Air Velocity

The air velocity across the stair door due to the stair pressurisation system when the stair door was open (Experiment SM8) is shown in Figure 6.2.6-1.

Once the smoke management system was activated the velocity across the door attained approximately 1 m/s as required by AS 1668.

6.2.7 Smoke Obscuration

The level of smoke obscuration measured in the centre of the ceiling of Room 101 as well as the associated temperature and detector activation times are as shown in Figures 6.2.7 - 1 to 6.2.7 -8. The smoke obscuration measured within the corridor and the return air ducts and the associated temperatures and detector activation times are as shown in Figures 6.2.7-9 to 6.2.7-16 and Figures 6.2.7-17 to 6.2.7-20 respectively.

The following significant results were obtained from the results:

1. Closure of the burn room door significantly increased the time to detection in the apartment (Room 101).

The optical detector activated prior to the ionisation detector in Room 101 and the corridor, but operated after the ionisation detector in the return air duct. This was considered to be due to the lack of duct probes for the detectors located in the return air duct. Hence the level of air movement within the duct was such that the ionisation detector was activated prematurely due to purging of the detection chamber by the air current.

2. The heat detector did not activate during any of the experiments.
3. The aspirating detector gave the quickest response of all the types of detector.

4. Activation of the smoke spill system generally appeared to delay the activation of the detectors within room 101 and the corridor; this was most likely due to extraction of the smoke directly into the return air duct from the burn room door. In some instance the activation of the smoke spill system prevented activation of any of the detectors within the corridor.

6.2.8 Detector Activation

The time to detection for the detectors located in the corridor, the return air duct and the apartment room (Room 101) are shown in Table 6-1.

The thermal detectors did not activate during these experiments. An air aspirated detection system was included in some experiments. Sampling points were located in the burn room (Room 102) and some in Room 101. This is considered to be a non-representative installation as such a detection system would normally have many more sampling points. Using this arrangement and depending on the sensitivity setting used, it was found on some occasions that detection was recorded during the ignition period prior to ignition of the specimen. For the reasons listed previously, it was decided not to tabulate the recorded detection times for the air aspirated system.

Table 6-1: Detector Activation Times For Smouldering Fire Experiments

EXPERIMENT ID	DETECTOR POSITION	IONISATION DETECTOR	PHOTO-OPTICAL DETECTOR	THERMAL DETECTOR
SM1	Apartment	6976	4200	-
	Corridor		7156	-
SM2	Apartment	698.3	1724	-
	Corridor		1680	-
SM3	Apartment	1879	546	-
	Corridor		1963	-
SM4	Apartment	407	949	
	Corridor		-	
SM5	Return Air Duct	2849	891	
	Apartment		539	
SM6	Corridor	4366	2555	
	Apartment		3136	2063
SM7	Corridor	4193	4193	
	Return Air Duct	440	1752	
	Apartment	2170	2145	
SM8	Corridor	3488	2456	
	Return Air Duct	1785	1777	
SM8	Apartment	293	1719	
	Corridor			

7. RESULTS OF SMALL ROOM FLAMING FIRE EXPERIMENTS

7.1 COMMERCIAL PRODUCT EXPERIMENTS

7.1.1 Mass Loss

A comparison of the mass loss during flaming fire experiments in the small room using commercially available lounge chair and the simulated chair under the same ventilation conditions (refer Figure 7.1.1-1) reveals that the commercially available chair experienced a significantly greater mass loss than the simulated chair. This was in part due to the back of the commercial chair containing the greatest amount of fuel and **dacron** that melted forming burning droplets that ignited the seat of the chair early in the fires development. The fire therefore spread rapidly to involve the whole chair. The simulated chair consisted. of polyurethane foam cushions with cotton-linen covers. The majority of the fuel load was located on the seat. Hence the rate of fire spread and therefore mass loss was lower due to the slower ignition of the seat and slower horizontal flame spread across the surface of the seat.

The glass located on the window on the southern side of the burn room cracked during both the commercial chair tests and the simulated chair tests. However, the glass did not **fracture** and no holes were created in the window. The degree of cracking was more severe for the commercial chair than the simulated **chair**. It was considered that had the window completely **fractured**, that “flashover” would have occurred with the commercial chair.

The fuel load and fuel **configuration** was chosen for the simulated chair so that the chair did not cause the small burn room to flashover but still gave a reasonable approximation of the commercially available chair.

7.1.2 Carbon Monoxide Concentration

The Carbon Dioxide concentration obtained at the top of the burn room door for both the commercially available chair and the simulated chair were as shown in Figure 7.1.2-1.

The CO concentration associated with the commercially available chair was far greater than that for the simulated chair due to the far greater burning rate as evidenced by the mass loss rate discussed previously.

It appears that untenability was not achieved on the basis of the 4% CO dosage for either the commercially available chair or the simulated chair.

7.1.3 Oxygen Concentration

A comparison of the oxygen concentration at the top of the burn room door for the product experiments is shown in Figure 7.1.3-1.

The commercially available chair exhibited a greater degree of oxygen depletion than the simulated chair due to the greater burning rate.

The degree of oxygen depletion in each experiment was not great enough to visibly effect the fires development. The reduction in the rate of burning was considered to be due to consumption of the rear of the chair leaving only the seat that burned at a slower rate due to the horizontal orientation.

7.1.4 Average Room Temperatures

The average room temperature obtained for both experiments are shown in Figure 7.1.4- 1. The average temperature includes temperature measurements recorded within the plume and the lower layer. These average room temperatures were obtained by taking the unweighted spatial average of all the thermocouples in the burn room.

The temperature obtained for the commercially available chair was approximately twice that for the simulated chair due to the higher burning rate. The peak temperature recorded for both experiments was associated with full involvement of the rear of the chair. Once the rear of the chair had been consumed the fire was not as intense.

The peak associated with the simulated chair was not as sharp as that for the commercial chair due to the involvement of the seat that had two cushions. The second and third peaks were associated with burning of the relatively large vertical face at the front and sides of the seat.

7.1.5 Visual Observations

The following events were noted during visual observation of the product experiments :-

1. The rate of fire spread for the commercially available chair was greater than the simulated chair due to the presence of the **dacron** and the greater fuel load located at the rear of the commercial chair.

2. The rate of fire spread for the commercially available chair increased dramatically when the back fell forward onto the seat and on to the floor below the chair due to melting of the dacron and the formation burning droplets and pools. The burning dacron was observed to “peel” away from the burning surface thereby exposing fresh unburnt material.
3. Flashover (window breakage) was not attained with either experiment however. The window did crack, but not completely fracture during both experiments. Sections of glass were not dislodged from the window frame during each experiment.

7.1.6 Summary

On the basis of the results presented herein it was decided to choose the simulated chair for subsequent experiments involving flaming fires. The simulated chair gave qualitatively similar results to the commercial chair. However, the results obtained for the simulated chair were generally lower (that is, not conservative) when compared with the results for the commercial chair. The simulated chair tended to give a lower bound result for both mass loss and CO concentration compared with the commercial product experiment. Considering the near “flashover” conditions (breakage of window glass) that was generated with the commercial chair, it was decided to adopt the simulated chair configuration as providing a more consistent representation of flaming (non-flashover) fires.

7.2 KITCHEN FIRE SIMULATION EXPERIMENTS

7.2.1 Mass Loss

The mass loss for the two kitchen fire simulation experiments, FMS1 and FMS2, are shown in Figures 7.2. 1-1 and 2. The mass loss data for the third kitchen fire experiment FMS3 was not valid due to activation of the sprinkler head causing instrumentation failure and therefore has not been included.

Ignition of the oil used as the initial fuel for the kitchen simulation experiments occurred in approximately 970 seconds for each experiment.

Examination of the result indicated that the activation of the air handling / smoke management system did not increase the rate of mass loss of the oil within the pot but did increase the overall total mass loss. The reason for the reduction in the mass loss of the fuel was considered to be due to oxygen depletion of the experiment without air handling (FMS1) compared to the experiment with air handling / smoke management (FMS2).

Application of the air supply prior to the activation of the smoke control system did not effect the time to ignition of the oil or the fires development. Once the smoke control system was activated the fire visibly increased in size and intensity. The cupboards and timber ~~frame~~ work located below the bench on which the pot of oil was located did not become involved during either experiment. However, the shelf arrangement above the pot did become involved and dropped onto the bench and the floor of the burn room. Accordingly, given appropriate conditions of ~~dislodgment~~, the cupboards could have become involved.

The initial rate of mass loss was similar for both FMS1 and FMS 2 which suggested that the experiment and fuel configurations were reasonably reproducible.

7.2.2 Average Room Temperatures

The average room temperatures for the burn room (Room 102), the apartment room (Room 101), and the second bed room (Room 103) for the kitchen fire experiment are shown in Figures 7.2.2 - 1 to 3. These average room temperatures were obtained by taking the unweighted spatial average of all the thermocouples in the room.

Examination of the results revealed the following points :

1. The temperature in the burn room was slightly higher for the experiment with smoke control (FMS2) than the experiment without smoke control (FMS1). This was considered to be due to the slightly more severe fire. Accordingly, even though the smoke control system was extracting the hot gas layer and therefore some of the heat, a higher average temperature may have been recorded because of possibly higher plume temperature and radiation to the thermocouples in the vicinity of the plume.
2. The other rooms on the level of fire origin (Rooms 101 and 103) recorded a lower average room temperature when the smoke control system was activated for FMS1 compared with FMS2 due to the extraction of the hot gas layer by the smoke control system.
3. Kitchen fire experiment FMS3 recorded a low average room temperature due to rapid extinguishment of the fire by the sprinkler system that was operational for that experiment. The average room temperature at sprinkler activation was approximately 62 °C.
4. Both the experiment without smoke control and the experiment with smoke control showed a similar shape of the temperature-time curve. It was considered that both fires behaved in a similar manner where the oil in the pot initially ignited and then began to boil, due to the radiation from the flames above the pot, and the oil gradually rose towards the top surface of the pot. A corresponding increase in the flame size and intensity was also observed at this stage leading to the second peak.

5. It appears that untenable conditions due to temperature were achieved in the burn room for FMS1 and FMS2 only. The criteria for untenable conditions due to temperature are assumed to be 100 °C.

7.2.3 Temperatures in the Corridor and Stair

The recorded temperatures within the corridor and at the stair door on level three of the EBFF are shown in Figures 7.2.3 - 1 to 7.2.3 - 4. The temperatures in the corridor were recorded at each thermocouple point along the corridor at a height of 1.9m.

The following significant features were observed :

1. The temperatures in the corridor for a single experiment did not show a large variation with distance from the apartment door (Door 1 approximately 7.5 m from the stair door). Further analysis is required to determine whether the corridor can be treated as one zone with regards temperature.
2. Activation of the smoke control system prevented the build up of heat within the smoke layer in the corridor yielding only a small increase in temperature.
3. None of the experiments produced untenable conditions within the corridor due to temperature.
4. No significant temperature rise was observed within the stair well at Level 3 of the EBFF for FMS-103. The difference in the initial temperatures between the experiment shown in Figure 7.2.3 - 4 was due to the difference in ambient conditions during the experiments. A drop in temperature was recorded in the stairwell for those experiments where the smoke management system was activated (experiments FMS2, FMS5 and FMS7) due to activation of the stair pressurisation system. Experiment FMS10 was the only experiment to exhibit an increase in temperature at Level 3 although this was only approximately 2.5°C.
5. A significant temperature rise was recorded within the corridor for FMS 1, even when the apartment door to the corridor (Door D1) was closed due to the apparent leakage of hot smoke around and below the door as indicated by the relatively high obscuration recorded within the corridor (refer Figure 7.2.7-4). The kitchen fire tests produced large amounts of black sooty smoke that filled the apartment room (Room 101) to floor level and hence the smoke could leak through the 12 mm gap at the base of the door. Experiment FMS2 did not record a significant temperature rise in the corridor due to the smoke being extracted into the return air duct and hence smoke logging of the apartment room did not occur to any significant degree.

7.2.4 Radiation from the Hot Gas layer

The levels of radiation from the hot gas layer and the fire plume to the radiometers located on the floor within the burn room (Room 102) and the apartment room (Room 101) are shown in Figures 7.2.4 - 1 to 7.2.4 - 3.

The levels of radiation from all three fires were not considered high enough to ignite nearby materials based on a minimum level of radiation to ignite easily ignitable materials, such as curtains, of 10 kW/m^2 .

The initial peak levels of radiation were similar for both FMS1 (2.9 kW/m^2) and FMS2 (3.2 kW/m^2) as would be expected from the similar average room temperatures. The slightly higher value for experiment FMS2 could have been the result of increased radiation from the more intense and slightly larger fire plume as a result of the activation of the air handling system. The large spike in the graph of radiation level for FMS1 is considered to be due to electrical interference and hence a comparison with FMS2 during the later stages of the fire could not be made.

7.2.5 Carbon Monoxide Concentration

The carbon monoxide concentrations recorded at a height of 1900 mm within the burn room door (Door D2), the apartment door (Door D1), the stair door (Door D9), and the exit door (Door D5) are shown in Figures 7.2.5 - 1 to 7.2.5 - 3.

Examination of the results indicate that:

1. It appears that untenability was achieved only within the burn room for all experiments for experiments FMS1 and FMS2. The fire was extinguished rapidly enough by the sprinkler in FMS3 to prevent the development of untenable conditions.
2. The activation of the smoke control system reduced the levels of CO within the burn room and at the burn room door. However, as the smoke extraction system required that the smoke be extracted through the burn room door, significant levels of CO were still recorded at the top of the door (1.9 m).
3. The rapid activation of the sprinkler system prevented the accumulation of significant quantities of CO within the burn room.
4. The levels of CO recorded in the burn room for the kitchen fires were significantly greater than those recorded for the commercially available or simulated chairs used in the product experiments as described in Section 7.1. These results suggest that a kitchen fire can be potentially more life threatening than a chair fire. The low loss of life associated with kitchen fires is expected to be caused by the occupants generally being alert as discussed in Section 5.

7.2.6 Carbon Dioxide and Oxygen Concentrations

The measured oxygen concentration within the bum room for each kitchen fire experiment is shown in Figures 7.2.6 - 1 to 7.2.6 - 3. The Carbon dioxide and oxygen concentrations at various heights in the bum room door (Door 2) are shown in Figures 7.2.6 - 4 to 7.2.6 - 6.

The significant results obtained were :

1. Activation of the smoke control system was considered to reduce the overall degree of oxygen depletion within the bum room compared to the experiment without smoke control within the bum room even though the minimum oxygen concentration for both tests FMS1 (13.7%O₂) and FMS2 (12%O₂) were similar. For experiment FMS2, where the air handling was activated, the oxygen content rapidly increased to almost ambient levels while for FMS1 the level remained low for an extended period. The slightly lower minimum oxygen concentration exhibited by FMS2 was considered to be insignificant.
2. The oxygen concentration within the bum room door was greater for FMS2 that had the smoke control system activated than for FMS1. Accordingly the levels of CO₂ within the burn room door were lower for FMS2 involving smoke control.
3. The concentration of CO₂ at lower levels within the bum room door were higher for the no smoke control case than when the smoke control system was activated. This effect was due to the extraction of the smoke from the burn room via the door at a high level preventing the build up of an extensive hot gas layer to low levels within the burn room.
4. Activation of the sprinkler system prevented the production of significant quantities of CO₂.

7.2.7 Smoke Obscuration

The levels of smoke obscuration measured in the centre of the ceiling of Room 101 as well as the associated temperature and detector activation times are as shown in Figures 7.2.7 - 1 to 7.2.7 -3. The levels of smoke obscuration measured in the corridor and the return air duct are shown in Figures 7.2.7-4 to 7.2.7-6 and Figure 7.2.7-7 respectively. Ignition of the vegetable oil appeared to produce a greater quantity of smoke than was produced during the commercial product tests. The smoke was also black and sooty resulting in almost complete obscuration within the burn room, Room 101 and the corridor immediately after full involvement of the oil as indicated by Figures 7.2.7-1 to 7.2.7-7. Even with the smoke control system activated, the bum room and apartment rooms became smoke logged. The smoke control system did however keep the corridor relatively clear of smoke. The

above results suggest that kitchen fires could be potentially more life threatening than furniture fires in terms of smoke obscuration and spread.

7.2.8 Detector Activation

The time to detection for the detectors located within the corridor the return air duct and the Apartment room (Room 10 1) are shown in Table 7- 1.

The following significant results were obtained from the results:

1. Activation of the smoke detectors in Room 101 occurred prior to or just after ignition of the oil within the pan.
2. The ionisation detector operated prior to the optical detector within Room 101 for experiments FMS1 and FMS3 while the optical detector operated first for FMS2. The difference was considered to be related the degree of fuming of the oil prior to ignition and the type and size of oil droplets within the aerosol produced by the hot oil.
3. The ionisation detector located within the corridor activated prior to the optical detector in all experiments. This is expected since the ionisation detectors are more sensitive to the smoke particles generated by a flaming fire.
4. Activation of the smoke spill system appeared to delay the activation of the detectors within the corridor slightly. The effect was less dramatic than that for the smouldering fires due to the greater quantity and buoyancy of the smoke produced.
5. Activation of the ionisation detector within the return air duct occurred rapidly due to the level of air movement and the lack of duct probes.
6. The thermal detector located within the apartment (Room 101) was the only thermal detector to activate during experiments FMS1 and FMS2.

Table 7-1: Detector Activation Times (seconds) for Kitchen Fire Experiments

EXPERIMENT	DETECTOR POSITION	IONISATION DETECTOR	PHOTO-OPTICAL DETECTOR	THERMAL DETECTOR
FMS1	Apartment	789	957	1090
	Corridor	835	1080	
FMS2	Apartment	1003	874	1152
	Corridor	1188	1249	
	Return Air Duct	153	803	
FMS3	Apartment	780	819	
	Corridor	977	1125	

Note: No entry means did not operate.

7.2.9 Sprinkler Activation

Sprinkler activation in experiment FMS3 occurred at 1093 seconds.

Immediately after sprinkler activation the fire flared outwards before dying down and subsequent extinguishment. The oil did not boil over out of the pan and no spread of fire was observed. Extinguishment occurred within 20 seconds from the time the sprinkler was activated.

The time for the glass bulb in the sprinkler system to shatter for the three kitchen fire experiments are shown in Table 7.2.

Table 7-2: Times for Sprinkler Head Activation for the Kitchen Fires

EXPERIMENT NUMBER	TIME TO SPRINKLER ACTIVATION (Seconds)	GAS TEMPERATURE AT SPRINKLER ACTIVATION (°C)
FMS1	-	-
FMS2	1121	206°C
FMS3	1093	230°C

No result was recorded for FMS1 as the glass bulb did not break the trip wire when it fractured.

Note: Because of the experimental configuration there is some **uncertainty** in the determination of the sprinkler activation time. This is due to the two ends of the trip wire retouching after it had broken.

7.3 SMALL ROOM CHAIR FIRE SIMULATION EXPERIMENTS

7.3.1 Mass Loss

The mass loss for the six single - seat chair fire simulation experiments, FMS4 - FMS8, and FMS10 are shown in Figures 7.3.1-1 to 7.3.6.

Examination of the mass loss results indicated :-

1. When there was increased ventilation through opening of the burn room door or the activation of the smoke control system there was an increased level of mass loss.
2. The initial rate of mass loss (ie within 300 seconds from the point of ignition) appeared to be similar for each pair of experiments with the same natural ventilation conditions (for example, FMS4 and 5, FMS6 and 7). Accordingly, it was considered that the rate of air supply was not great enough to effect the fire to any significant degree. The rate of mass loss increased for those experiments involving smoke control (FMS5 and FMS7) once the smoke control system had been activated compared to those without smoke control. This was considered to be due to the lower overall degree of oxygen depletion exhibited by those experiments involving smoke control (refer section 7.3.6). The rate of mass generally appeared to increase with an increase in natural ventilation (eg, FMS4 compared with FMS8)
3. The total mass loss recorded during FMS5, FMS7 & FMS10 was slightly greater than the actual fuel load placed on the weighing platform. This could have been caused by residual combustible material embedded in the cement sheeting of the weighing platform from previous tests. Another factor which may have attributed to this was the cement sheeting had an absorption of up to 30% moisture according to manufacturers.

7.3.2 Average Room Temperatures

The average room temperatures for the burn room (Room 102), the apartment room (Room 101), and the second bed room (Room 103) are shown in Figures 7.3.2 - 1 to 7.3.2-6. These average room temperatures were obtained by taking the unweighted spatial average of all the thermocouples in the room.

Examination of the results revealed the following points :

1. Activation of the smoke control system (refer to Section 7.3.8, return air duct) had a greater effect on the peak temperature within the burn room (Room 102) when the burn room door was closed (experiments FMS4 and 5) than when it was open (experiments FMS6 and 7). The effect of activation of the smoke control system with the burn room door closed was to increase the peak temperature.
2. Rooms 101 and 103 did not record a significant temperature rise when the burn room door was closed (experiments FMS 4 and 5)
3. Flashover was not achieved in any of the experiments however, the burn room window cracked in all the experiments.
4. Untenable conditions due to temperature were achieved in all the rooms (Room 101, 102 & 103) when the burn room door was open and only in the burn room when the burn room door was closed. The criteria for untenable conditions due to temperature are assumed to be 100 °C.
5. The average temperature obtained in the burn room with the burn room door open (FMS6) was comparable to that obtained for the product experiments described in Section 7.1.4 indicating a degree of repeatability in the experiments.

7.3.3 Temperatures in the Corridor and Stair

The temperatures recorded at a height of 1.9 m along the length of the corridor on level 1 of the EBFF are shown in Figures 7.3.3 - 1 to 7.3.3 - 6.

The following significant features were observed :

1. The temperatures in the corridor for a single experiment did not show a large variation with distance from the apartment door especially during the initial growth phase of the fire; Door 1 is approximately 7.5 m from the stair door. Further analysis is required to determine whether the corridor can be treated as one zone with regards temperature. The corridor is 13.5m long.
2. No significant temperature rise was recorded within the corridor when the apartment door (Door D1) was closed.
3. None of the experiments produced untenable conditions in the corridor due to temperature. The temperatures in the stair at Level 3 for experiments FMS4-8 and FMS10 are shown in Figure 7.2.3-4.

7.3.4 Radiation from the Hot Gas layer

The levels of radiation from the hot gas layer and the fire plume to the radiometers located on the floor in the burn room (Room 102) and the apartment room (Room 101) are shown in Figures 7.3.4 - 1 to 7.3.4 - 6.

The levels of radiation from all fire experiments was not considered high enough to ignite nearby materials based on a minimum level of radiation to ignite easily ignitable materials such as curtains of 10 kW/m^2 .

Untenability on the basis of 2.5 only obtained in the burn room for experiments FMS5 (at 1800 seconds) and FMS7 (at 400 seconds) both of which had the smoke control system activated. This was considered to be due to the smoke control system preventing oxygen depletion of the fire to the same extent as occurred with no smoke control and hence increasing the burning rate and level of radiation. This was observed visually during the fire experiments where the fires with the smoke control activated produced brighter, longer flames.

7.3.5 Carbon Monoxide Concentration

The carbon monoxide concentrations recorded at a height of 1900 mm within the burn room door (Door D2), the apartment door (Door D1), the stair door (Door D9), and the exit door (Door D5) are shown in Figures 7.3.5 - 1 to 7.3.5 - 6.

Examination of the results indicate that :

1. Untenability was only achieved within the burn room for experiments FMS4 and FMS5 where the burn room door was closed.
2. Activation of the smoke control system reduced the CO concentration in the burn room when the burn room door was closed. The CO levels for all other experiments were too low to detect a significant variation.

7.3.6 Carbon Dioxide and Oxygen Concentrations

The measured carbon dioxide oxygen concentrations in the burn room for each flaming fire experiment is shown in Figures 7.3.6 - 1 to 7.3.6 - 6. The Carbon Dioxide and Oxygen concentrations at various heights in the burn room door (Door 2) are shown in Figures 7.3.6 - 7 to 7.3.6 - 12.

Some of the significant results obtained are listed below:

1. Activation of the smoke control system slightly reduced the extent of Oxygen depletion by approximately 1 percent (7.5% and 17% O₂ for FMS 4 and FMS6 compared with 8.5% and 18% O₂ for FMS5 and FMS7). Once the smoke control system was activated the level of oxygen in the bum room increased more quickly than those experiments without smoke control.
2. The greater the degree of natural ventilation in terms of door opening exhibited lower oxygen depletion than those experiments with doors closed; for example, FMS 10 exhibited lower oxygen depletion than FMS8 that was lower than FMS6 etc.
3. The minimum level of oxygen depletion within the bum room door was not as great for those experiments involving smoke control compared to those experiments without air handling / smoke control. The oxygen concentration also returned to close to ambient levels quicker for those experiments involving smoke control than those without smoke control.
4. Natural ventilation via open doors reduced the level of oxygen depletion in the bum room door.
5. The oxygen concentration within the bum room door exhibited a distinct boundary at approximately 0.3 m for experiments with the bum room door closed (FMS4 and 5). This was considered to be the height of the upper hot gas layer. For experiments with the bum room door open the boundary initially occurred at 1.4 m and then dropped to 0.3 m later in the experiments due to dropping of the smoke layer as the fire became smaller due to consumption of the available fuel.
6. As expected the higher the oxygen concentration the lower the CO₂ production

7.3.7 Smoke Obscuration

The level of smoke obscuration measured in the centre of the ceiling of Room 101 as well as the associated temperature and detector activation times were as shown in Figures 7.3.7 - 1 to 7.3.7 -6. The level of smoke obscuration measured in the corridor and the return air duct is shown in Figures 7.3.7-7 to 7.3.7-12 and Figures 7.3.7-13 and 7.3.7-14 respectively.

The following significant results were obtained:

1. The smoke density was lower for those experiments in which smoke control was used due to the extraction of the smoke.

2. The ionisation detector located in the centre of Room 101 and the corridor activated prior to the optical detector in all experiments
3. With the burn room door closed the thermal detector in Room 101 did not activate.
4. The optical smoke detectors activated at an obscuration of 0.08 - 0.1 the ionisation detectors activated a level of 0.01 - 0.02 db/m. No correlation of smoke detector activation and temperature was evident.
5. Activation of the smoke spill system prevented any build up of smoke in the corridor and hence none of the detectors activated.
6. Activation of the ionisation detector in the return air duct occurred rapidly due to the level of air movement and the lack of duct probes.
7. The thermal detector located within the apartment (Room 101) was the only thermal detector to activate during the experiments. Activation occurred at a later stage than activation of both the smoke detectors but was only marginally longer than that for the optical detector.

7.3.8 Detector Activation

The time to detection for the detectors located in the corridor, the return air duct and the Apartment room (Room 101) are shown in Table 7.3.

Table 7-3 Detector Activation Times for Small Room Chair Fire Experiments

EXPERIMENT	DETECTOR POSITION	IONISATION DETECTOR	PHOTO-OPTICAL DETECTOR	THERMAL DETECTOR
FMS 4	Apartment	221	329	
	Corridor	758	625	
	Return Air Duct	317	659	-
FMS 5	Apartment	216	328	-
	Corridor			-
	Return Air Duct	77	212	
FMS 6	Duct	77		
	Apartment			192
	Corridor	183	162	
	Return Air Duct	189	343	
FMS 7	Apartment	81	162	173
	Corridor			-
	Return Air Duct	48	127	-

FMS 8	Apartment Corridor Return Air Duct	87 111 227	175 201 508	191 - -
FMS 10	Apartment Corridor Return Air Duct	68 93 194	161 179 738	203 -

7.3.9 Sprinkler Activation

The time for the glass bulb within the sprinkler system to shatter for all the large room flaming tests are shown in Table 7.4.

Table 7-4: Times and Temperatures for Sprinkler Head Activation for the Small Room Fires

EXPERIMENT NUMBER	TIME TO SPRINKLER ACTIVATION (Seconds)	GAS TEMPERATURE AT SPRINKLER ACTIVATION (°C)
FMS4	-	
FMS5		
FMS6	220	160
FMS7		
FMS8	280	219
FMS10		-

The nil results were due to experimental difficulties.

Note: Because of the experimental configuration there is some uncertainty in the determination of the **sprinkler** activation time. This is due to the two parts of the broken trip wire retouching.

8. RESULTS OF LARGE ROOM FLAMING FIRE EXPERIMENTS

8.1 COMMERCIAL PRODUCT EXPERIMENTS

8.1.1 Mass Loss

Comparison of the mass loss during flaming fire experiments in the large burn room using a commercially available 3 seater couch, a double bed inner spring mattress plus base, a double bed polyurethane mattress and a simulated three seater couch under the same ventilation conditions (refer Figure 8.1. 1-1) indicate the following significant features:

1. The commercially available double-bed mattress plus base resulted in the greatest mass loss followed by the commercial 3 seater couch, the commercial polyurethane mattress and the simulated 3 seater couch. The simulated 3-seater couch exhibited a similar overall mass loss compared with the double-bed mattress and base over the first 400 seconds.
2. The commercial 3 seater couch showed a slow initial mass loss due to horizontal spread of the fire over the surface of the couch seat associated with what appeared to be the acrylic fabric only. The rapid mass loss after 500 seconds was associated with the involvement of the back of the couch.
3. The rapid mass loss associated with the simulated 3 seater couch was due to involvement of the large vertical face at the front of the seat due to the two cushions placed one on top of the other and ignition of the bottom side of the seat.

8.1.2 Carbon Monoxide Concentration

The Carbon monoxide concentration obtained at the top of the burn room door for both the commercially available chair and the simulated chair were as shown in Figure 8.1.2-1.

The CO concentration associated with the commercially available 3 seater couch was far greater than that for the fuel loads due to the greater burning rate as evidenced by the mass loss rate discussed above. The peak in the CO concentration for the 3 seater couch was associated with the rapid mass loss due to involvement of the back of the couch.

The simulated 3 seater couch showed a more rapid rise in the CO concentration than the other furniture items due to the rapid involvement of the couch due to ignition below the couch and the vertical front face of the seat.

Untenability was achieved on the basis of the CO concentration for all the furniture items except for the simulated couch using untenability of 4 %min as a basis. Untenability was achieved earliest for the commercial 3 seater couch and hence a couch arrangement could be chosen for the large room experimental fires over the simulated mattress.

8.13 Oxygen Concentration

A comparison of the oxygen concentration at the top of the burn room door for the product experiments is shown in Figure 8.1.3- 1.

The commercially available 3 seater couch exhibited a greater degree of oxygen depletion than the other furniture items due to the greater burning rate.

The degree of oxygen depletion for the commercial 3 seater couch and the commercial inner spring mattress and base was great enough to, visibly effect the fire with the flames becoming a deeper orange colour and slower moving and the smoke becoming more sooty.

8.1.4 Average Room Temperatures

The average room temperatures obtained for each of the experiments are shown in Figure 8.1.4-1. The average temperature includes temperature measurements recorded within the plume and the lower layer. These average room temperatures were obtained by taking the unweighted spatial average of all the thermocouples in the burn room.

The average room temperatures for the commercial and the simulated 3 seater couches were similar.

The second temperature peak observed with the simulated 3 seater couch was associated with full involvement of the rear of the couch.

The lowest average room temperatures were obtained with the commercial polyurethane mattress

8.1.5 Visual Observations

The following events were noted during visual observations of the product experiments :

1. The rate of initial mass loss of commercial 3 seater couch was low due to what appeared to be the fire only involving the acrylic fabric on the surface of the seat of the couch and the slow horizontal flame spread. The polyurethane on the seats did not become involved in the fire to any marked degree until much later in the fire. The rapid increase in the mass loss was associated with the rear cushion of the couch becoming involved that was made of dacron and therefore spread the fire rapidly both through and up the rear and front faces of the cushion and also horizontally across the face of the rear cushion. It was not until the rear cushion had become involved that the seat of the couch began to burn vigorously. The fire therefore spread from the front of the couch to the rear across the surface of the cushions and then back towards the front once the rear cushions were involved.
2. The simulated 3 seater couch exhibited a rapid initial mass loss due to involvement of the large vertical front face of the two cushions forming the seat of the couch and ignition of the underside of the couch. The ignition source was placed on the floor in front of the centre of the couch and hence the flames were able to ignite the underside of the front cushions resulting in a large scalloping of the front face of the seat of the cushions. The fire therefore spread rapidly across the front of the couch and towards the rear from below the couch. This could not be achieved with the commercially available couch due to the base of the cushions on the seat being formed from solid timber.
3. The commercial mattress and base exhibited a rapid increase in the fire initially associated with the side of the base and mattress igniting quickly due to the thin covering of foam and fabric over the frame and springs. After the initial flare up of the fire the fire died down and flame spread occurred horizontally across the surface of the mattress resulting in small weak flames. A second stage of intense burning followed associated with the pillows.
4. Flame spread on the commercially available polyurethane mattress occurred horizontally across the upper surface resulting in a relatively small fire. The cotton sheets and doona cover appeared to prevent rapid involvement of the mattress.
5. The glass in the burn room window cracked during all the commercial product experiments but did not fracture nor was it dislodged. The degree of cracking was greatest for the commercial 3-seater couch followed by the simulated couch and commercial double bed mattress and base. It was considered that had the window completely fractured during the commercial 3-seater couch experiment then “flashover” could have occurred. Accordingly, it would appear that the

simulated 3-seater couch should have a slightly lower fuel load and fuel distribution compared with the commercial couch.

8.1.6 Summary

On the basis of the results presented herein it was decided to choose the simulated couch for subsequent experiments involving flaming fires. The simulated couch gave qualitatively similar results to the commercial products (couch, polyurethane mattress and inner-spring mattress). However, the results obtained for the simulated couch were generally lower (that is, not conservative) when compared with the results for the commercial products. The simulated couch tended to give a lower bound result for both mass loss and CO concentration compared with the commercial product experiments. The commercial 3 seater couch gave maximum/minimum results for CO, O₂ and temperatures. The simulated couch produced a similar maximum temperature to the commercial 3-seater couch. Considering the near "flashover" conditions (breakage of window glass) that were generated with the commercial products, it was decided to adopt the simulated couch configuration as providing a more consistent representation of flaming (non-flashover) fires in a large room.

8.2 LARGE ROOM CHAIR FIRE SIMULATION EXPERIMENTS

8.2.1 Mass Loss

The mass loss for the large room fire simulation experiments, FML1 - FML7 are shown in Figures 8.2.1-1 to 8.2.1-7

Examination of the mass loss results indicate that:

1. Increased ventilation through opening of the bum room door or the activation of the smoke control system increased the total mass loss and rate of mass loss.
2. The initial rate of mass loss was similar for all experiments thereby suggesting a degree of repeatability in the initial stages of the experiments. This initial rate of mass loss, which was very low, was on average over a period of 200 seconds.
3. The experiments involving smoke control were of a shorter duration than those with no smoke control due to the expected better ventilation causing the more rapid mass loss and burning rate.
4. The mass increase in FML7 was due to the water from the sprinkler on the mass platform

5. The total mass loss recorded during FML5 & FML6 was greater than the actual fuel load placed on the weighing platform. This could have been caused by residual material embedded in the cement sheeting of the weighing platform from previous tests. Another factor which may have attributed to this was the cement sheeting had an absorption of up to 30% moisture according to manufactures.

8.2.2 Average Room Temperatures

The average room temperatures for the burn room (Room 102/103) and the apartment room (Room 101) that was closed off from the rest of the building are shown in Figures 8.2.2 - 1 to 8.2.2-7. These average room temperature were obtained by taking the unweighted spatial average of all the thermocouples in the burn room.

Examination of the results reveal the following:

1. The experiment performed with the burn room door closed and smoke control activated (FML2) exhibited a higher average room temperature than the experiment with the door closed and no smoke control. (FML1). However, with the burn room door open a lower average room temperature was recorded when the smoke control was activated (FML 4 and 3). This was opposite to that recorded in the small burn room where the smoke control system resulted in higher average room temperatures.

The difference in behaviour was considered to be the result of the variation in the effects of the increased ventilation with the smoke control activated and the decrease in the size of the hot gas layer and hence lower radiation feedback. With the large burn room door closed or the small burn room the increased ventilation appeared to have a greater effect of increasing the burning rate of the fuel due to the higher oxygen concentration than the reduced radiation feed back to the fuel from the hot gas layer. With the burn room door open in the large burn room the effect of the increased ventilation due to the smoke control system may not have been as great due to the larger volume of the room and the smaller hot gas layer had more of an effect on the burning rate and hence average room temperature.

2. Room 101 did not record a significant temperature rise as it was effectively sealed from the rest of the building.
3. Flashover (glass dislodgment) was not achieved in any of the experiments however, the burn room window cracked in all the experiments.
4. Untenable conditions due to temperature were achieved in the burn room in experiments FML1 to FML6. Untenability was not achieved in experiment FML7 due to activation of the sprinkler.

5. The average temperatures in the burn room with the burn room door open (FML3) was comparable to that obtained for the product experiments described in Section 8.1.4 indicating a degree of repeatability in the experiments.

8.2.3 Temperatures in the Corridor and Stair

The temperatures at a height of 1.9 meters in the corridor on Level 1 of the EBFF are shown in Figures 8.2.3 - 1 to 8.2.3 - 7. The apartment door was located 7.5m from the stair door.

The following significant features were observed :

1. The temperatures in the corridor did not show a large variation with distance from the apartment door for the experiments with the burn room door closed and to a lesser extent with the stair door closed. This effect was similar to that for the small burn room experiments.
2. Activation of the smoke control system reduced the temperatures in the corridor.
3. Untenability was not produced in the corridor when the burn room door was closed.
4. Untenability was produced in the corridor when the burn room door was open even when the smoke control system was activated.

8.2.4 Temperature in the Stair Well On Level 3

The temperatures recorded in the stair well on Level 3 were as shown in Figure 8.2.4-1. The vertical displacement of the temperatures was due to the variation in initial ambient temperatures when the experiments were conducted.

The results indicate that activation of the smoke control system and/or closure of the stair well door prevented any significant temperature rise in the stair well. The exception was experiment FML5 where the stair door and apartment door were open and the smoke control system was not activated. Accordingly, there was no hindrance to smoke flow up the stair to Level 3.

Untenability was not achieved in the stairwell on the basis of temperature during any of the experiments

8.2.5 Radiation from the Hot Gas layer

The levels of radiation from the hot gas layer and the fire plume to the radiometers located on the floor in the burn room (Room 102/103) are shown in Figures 8.2.5-1 to 8.2.5-7.

The level of radiation from all the fire experiments was not considered high enough to cause ignition of a second item. Therefore a second item would have to be ignited if flashover was to occur.

Experiment FML1 with the burn room door closed and no smoke control did not attain a radiation level sufficient to cause the ignition of an easily ignitable material. All other experiments attained a level of radiation considered to ignite easily ignitable materials (such as curtains) but not achieve a level of radiation sufficient to ignite “normal” items such as upholstered furniture that would require a level of approximately 20 kW/m^2 .

Untenability on the basis of 2.5 kW/m^2 was obtained within the burn room for all experiments except FML7 due to activation of the sprinkler.

8.2.6 Carbon Monoxide Concentration

The carbon monoxide concentrations recorded at a height of 1900 mm in the burn room door (Door D2) and the stair door on Level 3 are shown in Figures 8.2.6-1 to 8.2.6-7.

Examination of the results indicate:

1. Untenability was not achieved on Level 3 during any experiment and was not achieved in the burn room for those experiments where the smoke control system was activated. Untenability was achieved for those experiments where no smoke control was operational.
2. Activation of the smoke control system significantly reduced the CO concentration within the burn room.
3. The level of CO for experiment FML7 continued to rise after sprinkler activation due to the sprinkler not effectively extinguishing the fire that was protected on the underside of the couch.

8.2.7 Carbon Dioxide and Oxygen Concentrations

The measured oxygen concentration in the burn room for each of the experiments is shown in Figures 8.2.7 - 1 to 8.2.7 - 7. The Carbon dioxide and oxygen concentrations at various heights in the burn room door (Door 2) are shown in Figures 8.2.7-8 to 8.2.7-14.

The significant results obtained were:

1. Activation of the smoke control system reduced the extent of Oxygen depletion and increased the level of oxygen quicker than those experiments without smoke control.
2. Untenability due to oxygen depletion was only achieved for the experiments where the burn room door was closed (FML1 and 2) and experiment FML5.
3. The oxygen concentration in the burn room door generally exhibited a boundary at approximately 0.3 m especially when the smoke control system was activated.

8.2.8 Smoke Obscuration

The level of smoke obscuration measured in the corridor adjacent to the burn room door as well as the associated temperature and detector activation times are shown in figures 8.2.8-1 to 8.2.8-10. The following significant results were observed:

1. Closure of the burn room door prevented the development of high obscuration levels in the corridor.
2. Activation of the smoke control system did not prevent the development of a dense smoke cloud in the corridor when the burn room door was open.
3. The sprinkler system activated sufficiently to prevent significant smoke spread out of the burn room.

8.2.9 Detector Activation

The time to detection for the detectors located in the corridor, the return air duct and the bum room (Room 102/103) are shown in Table 8.1.

Table S-1: Detector Activation Times (Seconds) for Small Room Chair Fire Experiments

EXPERIMENT	DETECTOR POSITION	IONISATION DETECTOR	PHOTO-OPTICAL DETECTOR	THERMAL DETECTOR
FML1	Burn Room	42	72	87
	Corridor	168	195	
FML2	Burn Room	40	75	78
	Corridor	622		
	Return Air Duct	40	78	
FML3	Burn Room	34	77	92
	Corridor	106	205	222
	Burn Room	29	78	90
	Return Air Duct	83	173 94	222
FML5	Burn Room	35	91	100
	Corridor	94	175	212
FML6	Burn Room	89	75	83
	Corridor		173	180
	Return Air Duct	42	91	
FML7	Burn Room	33	68	86
	Corridor	93	147	-

Note: No entry means did not activate.

8.2.10 Air Velocity

The air velocity across the stair door (Door 9) due to the stair pressurisation system when the stair door was open (Experiment FML6) is shown in O-1.

Once the smoke management system was activated the velocity across the door attained a level of 1 m/s or greater as required by AS 1668.

The reason for the initial peak is unclear. It may have been due to the wind as it occurred before the smoke control system was activated. The later peaks could also have been due to the wind blowing through the stair pressurisation fan and dampers that were relatively exposed during the tests.

8.2.11 Sprinkler Activation

Sprinkler activation occurred at 146 seconds in experiment FML7 where the sprinkler system was charged with water and operated as a normal sprinkler system.

The sprinkler did not suppress the fire successfully due to protection of the underside of the couch by the cushions on the seat that were covered in an acrylic fabric that was water resistant. Accordingly the water from the sprinkler could not penetrate the cushions to get at the seat of the fire. Once the water to the sprinkler head had been shut off the fire would reignite due to the smouldering polyurethane on the under side of the cushions. The fire was finally extinguished using a hose stream and portable extinguishers.

The time for the glass bulb within the sprinkler system to shatter for each of the large room flaming tests are shown in Table 8.2.

Table 8-2 : Times and Temperatures for Sprinkler Head Activation for the Large Bum Room

EXPERIMENT NUMBER	TIME TO SPRINKLER ACTIVATION (SECONDS)		GAS TEMPERATURE AT SPRINKLER ACTIVATION (°C)	
	Room 102	Room 103	Room 102	Room 103
FML1	173	224	154	277
FML2	162	195	166	234
FML3		337		319
FML4	-	226		112
FML5	197	233	161	299
FML6	1.56		198	
FML7	146		193	

Note: Because of the experimental configuration there is some uncertainty in the determination of the sprinkler activation time. This was due to the ends of the broken trip wire reconnecting.

9. SUMMARY

9.1 SUMMARY OF EXPERIMENTAL PROGRAM

A total of 7 commercial product experiments using commercially available furniture items and 24 experiments using simulated furniture and ignition sources were performed.

The number of experiments, and the fuel load items used in each stage of the experimental program were:-

Smouldering Experiments (Room size 2.4 m x 3.6 m) - Three commercial product experiments (arm chair, single inner spring mattress, & single polyurethane mattress)

- Eight simulated furniture experiments (chair)

Small Room Flaming Experiments- (Room size 2.4 m x 3.6 m) - One commercial product experiments (arm chair)

- Nine simulated furniture experiments (3 kitchen, & 6 arm chair)

Large Room Flaming Experiments (Room size 5.4 x 2.5 m) - Three commercial product experiments (3 seater lounge suite, double bed + base, double polyurethane mattress)

- Seven simulated furniture experiments (3 seater lounge suite)

Air supply was activated in 10 experiments; 4 smouldering experiments, 1 small burn room flaming kitchen fire experiment, 2 small room flaming arm chair experiments, and 3 large room flaming three seater couch. Sprinklers were used in 2 experiments; namely a kitchen and a 3 seater couch configuration.

Physical quantities measured at various locations in the EBFF during each test were:

1. Mass loss rate (burn room only)
2. Temperature (all compartments and doors Level 1 and Level 3)
3. Pressure (between Level 1 and Levels 1M and 2)
4. Species concentrations (all compartments and doors Level 1 and Level 3)
5. Smoke density (all compartments Level 1 and return air duct)
6. Smoke velocity (burn room door, stair door)
7. Time of detector activation

8. Time of sprinkler activation

9.2 SUMMARY OF RESULTS

The main qualitative results to arise from the experimental program, based on a visual examination of the experiments and analysis of the data, are as follows:

9.2.1 Commercial Product Experiments

Supplementary experiments involving ignition of the commercially available fuel loads was performed to serve as a comparison between the physical fire environment produced by the commercially available furniture and that produced by the simulated furniture. An assessment of the severity of the conditions reported for the various experimental scenarios compared with that expected in real apartment situations can also be made. The comparison of the fire environment for the various furniture items was made in terms of the mass loss, CO concentrations, and temperatures generated.

Smouldering of the commercial lounge chair was far more severe in terms of the mass loss rate and CO concentration than the polyurethane mattress or inner spring mattress. Hence the experimental program used a simulated chair that produced similar levels of CO and total mass loss.

For the small room flaming fires, only a lounge chair was used due to concerns that other items of furniture may have resulted in flashover. The simulated chair arrangement was modified from the standard cushion arrangement (as used in the smouldering fire experiments) to one having a total of five cushions (three on the back and two on the base) based upon the results of the commercial product experiment.

A 3 seater couch, a double bed polyurethane mattress and a double bed mattress and base were used in flaming fire experiments in the large burn room. The 3 seater couch was more severe in terms of the size of the fire, heat release rate, temperatures and levels of smoke and CO than the polyurethane mattress followed by the mattress and base. The conventional single layer of cushions on the back and seat of a simulated three seater couch was modified to contain a single cushion on the rear and two polyurethane slabs on the seat based on the results of the above experiments.

9.2.2 Smouldering Experiments.

The smouldering experiments were performed in the small burn room using a standard simulated chair arrangement.

A summary of the results is given below:

1. Only one experiment was performed for each natural ventilation / air handling and smoke management combination. From a comparison of the results from all the experiments it was found that some level of repeatability existed during for the early stages of the experiment.
2. The degree of natural ventilation (in terms of the door positions) or the activation of the smoke control system did not appear to significantly effect the rate of smouldering.
3. For the smouldering fires the levels of CO reached values greater than 0.3 % only with the burn room door closed. During all other smouldering experiments the levels of CO were 0.05 % or less in all areas.
4. The duration of the smouldering tests varied from 50 minutes to 166 minutes depending on the time that the smouldering transformed into flaming or smouldering ceased.
5. During the period that the smoke control system was activated, the levels of CO were kept below 0.02% in all areas including the burn room. When the burn room door was closed smoke was observed to be extracted from below the door and around the edges of door.
6. Some layering of the smoke was initially observed in all the experiments; however, as the experiment progressed smoke layering became less distinct.
7. The supply of air to the burn room, prior to the activation of the smoke control system, did not appear to effect the degree of smoke layering during any of the experiments using air handling compared to those that did not use the air handling system. During the smouldering experiments a small zone of clearer air was found to be present in the immediate vicinity (within 10 cm) of the air supply vent in the burn room.
8. Smoke entered the corridor when the apartment door was open but the levels of CO and temperatures were below untenability levels.

9. Untenability in terms of the temperature was not achieved during any of the experiments. It appeared that untenability due to CO was only achieved in the bum room with the burn room door closed using a limit of 4 % \dot{m} or 0.06 % hr.
10. The normal sensitivity commercial photo optical smoke detector in the apartment room activated prior to the normal sensitivity commercial ionisation smoke detector during each experiment.
11. The thermal detectors in the apartment room did not activate during any of the smouldering experiments
12. Three air aspirated detector configuration were used during some of the experiments, The units were located in the burn room (0.1 %), around the return air duct grill (0.5%) and within the apartment (1%). All three air aspirated detectors activated prior to any of the other detectors.

9.2.3 Flaming Fire Experiments

The flaming fire experiments were performed in both small and large size burn rooms. Experiments conducted within the small size bum room used either a mock up kitchen arrangement or a simulated lounge chair as the fuel load. The experiments conducted in the large burn room used a 3 seater couch as the fuel load.

A summary of the results is given below:

1. Both the small room kitchen fire tests went for approximately 45 minutes. The small room chair fire experiments lasted approximately 25 minutes to 58 minutes. The large bum room fire experiments were conducted for a duration of 12 to 65 minutes.
2. Air supply prior to the activation of the smoke control system did not appear to effect the development of the fires. Once the smoke control system was activated the fires visibly increased in both size and rate of mass loss. A higher peak temperature was generally recorded for those fires where the smoke control system was activated in the small burn room but a lower temperature was generally recorded for those experiments performed in the large burn room.
3. Activation of the smoke control system reduced the quantity of smoke and the concentration of gases in all experiments using the air handling system, even if the doors were closed.

4. Significant levels of smoke reached Level 3 only during the large burn room experiment under natural ventilation conditions with the burn room and stair doors open. The temperature rise and concentration of gases detected were only minor; for example, a temperature rise of approximately 20⁰C.
5. It appeared that untenability was achieved in the burn room based on both temperature and CO concentration during all experiments. Untenability only occurred in the corridor for the large burn room experiments where the burn room door was open.
6. Sprinkler activation during the kitchen experiment caused the fire to flare momentarily and then the fire was extinguished within 1 minute of sprinkler activation. Activation of the sprinkler during the large burn room 3 seater couch experiment caused the fire to be reduced in intensity but the fire was not extinguished for a period of 2 - 3 minutes due to protection of the underside of the couch by the acrylic coverings that were partially water proof. Once the flames had been extinguished the water was shut off and after which the fire re-ignited. This occurred on three occasions.
7. During the kitchen fire experiments both the photo optical and ionisation smoke detectors in the return air duct and the apartment activated prior to the occurrence of any flaming combustion.
8. The ionisation detectors in the apartment room (Room 101) activated prior to the photo optical detectors during all of the flaming fire experiments within both size rooms.
9. Ventilation control of the fires due to oxygen depletion was achieved during all experiments in both size burn rooms. The fires were more intense in terms of the size of flames, temperatures, and heat release rate with the greater the ventilation ie more doors open.

10. CONCLUSIONS

The principal findings ~~from~~ the experiments were:

1. Untenable conditions due to a smouldering fire are only likely to occur in small closed rooms.
2. Normal air supply, as with an air **handling**, is unlikely to effect the development of a flaming fire if the flow rates are not high, but can increase the chance that a smouldering fire will transform into a flaming fire.
3. The activation of smoke spill and smoke **control systems** can increase the intensity of a flaming fire but will also remove the smoke and toxic gases from the compartments. The smoke control systems did not reduce the level of heat within the compartments **and** hence untenability could still be achieved in the enclosure of fire origin.
4. Operation of the photo optical detector located within the apartment room activated before the ionisation detector for the smouldering fires but after the ionisation detector for the flaming fires.
5. The smoke control system increased both the size of flaming and the temperatures in the burn room.
6. Smoke spread to other levels in the building did not cause untenable conditions to be reached in these levels.
7. An extensive amount of experimental data was collected during the project. This will provide valuable data for subsequent analysis and comparison with predicted results.

A comprehensive experimental program was conducted to consider the effects of combinations of different realistic fuel and ventilation conditions on the resulting fire environment in a prototype apartment building. Detailed experimental data, which was collected during this experimental program, will subsequently be compared with predictions obtained from computer models with the aim of **modifying/validating** the computer models to predict the fire environment under such realistic conditions.

11. ACKNOWLEDGMENTS

This project was undertaken with funding assistance provided by the Australian Building Research Grants Scheme and with a similar level of resources provided by the University.

This project was undertaken with the assistance of Mr. S. Stewart and Mr. M. Coles who were responsible for the experimental building layout, instrumentation setup, data recording and conduct of the experiments. This report was prepared with the assistance of Ms. T. Alam, Mr. B. Doughty, Mr Y. He and Mr M. Luo were responsible for the data conversion and collation; Ms. T. Alam also contributed to the text of the report.

12. REFERENCES

1. "Australian National Fire Incident Statistics 1989-1990", Technical CSIRO Division of Building, Construction and Engineering, October 1992.
- 2 Beck, V., He, Y., Stewart, S., Luo, M., Szmalko and White, B. (1995). "Experimental Validation of the NRCC fire growth model". CESARE Report No. 95-001. : Centre for Environmental Safety and Risk Engineering, Victoria University of Technology, July.
3. Hall, J.R., " Selections from the U.S. Fire Problem Overview Report through 1993, Leading Causes and Other Patterns and Trends, Hotels and Motels and Apartments", National Fire Protection Association, 1995.
4. Ramsay, C.G. and 1985, " A Protocol for Assessment of Smouldering Behaviour of Upholstery Combinations ," Division of Building Research Report No. R85/2

APPENDIX A
INSTRUMENTATION

A.1. Igniter

The igniter used for all smouldering fires was based on a unit developed by and AP. Cerra (1985), CSIRO Australia, for igniting smouldering, upholstery fires. The igniter was designed to simulate cigarette ignition of fires more reliably and consistently. Power to the electric igniter was supplied by a commercially available DC power supply. The power supply is continuously variable up to a supply current of typically 12 Amps. Table A 1 gives the calibration results of igniter surface temperatures against supply current. The igniter design allows for the controlled ignition of smouldering fires with a reduced chance of flaming occurring. Experiments were conducted using the igniter with higher current rates to determine its feasibility for use with flaming and flash over fires. It was the results that at higher current rates the ignition of flaming fires is possible.

Table A.1 Result of Igniter Tests.

Applied current (Amp)	Resultant final temperature (°C)
4	290
6	460
8	595
10	725
10.5	755
11	787
12	840

The electric igniter head consists of an electrically heated nichrome wire coil enclosed in both an inner ceramic tube and an outer stainless steel tube. It was mounted to a custom built support assembly designed to provide the desired reach for various experimental conditions (Figure. A 1). The force exerted by the igniter on the fuel specimen was adjusted by varying the counter weight location along the igniter assembly.

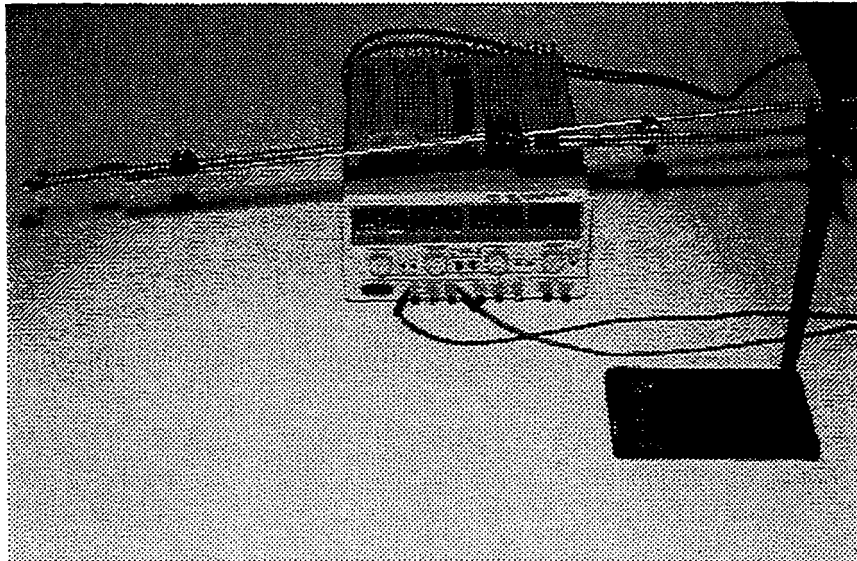

Figure A.1 Electric igniter

A.2. Thermocouples

Temperatures throughout the EBFF were measured with Nickel-Chromium, Nickel **Aluminium** (“K” type) thermocouples. Most thermocouple wires were mineral insulated and metal sheathed (**MIMS**) and some **fiberglass**. **Mims** provided mechanical and electrical protection and contamination barrier to **undesirable** gases. **Fiberglass** thermocouples were used on the upper levels where temperatures are lower.

The majority of thermocouples were mounted on stainless steel grid supports situated within the burn room and corridor to enable easy access and handling of the thermocouples during room modifications and rebuilds. Thermocouples were placed at every grid line intersection of the racks. The positions of the racks are marked in Figure 4.1. The racks within the burn room were hung **250mm from** the ceiling of the **first** floor.

The thermocouples were wired to **custom-built** instrumentation housings located in the instrumentation room (Room 104). The **instrument** housings **contain** voltage **amplifiers** and dedicated electronics to characterise the specific thermocouples used

All thermocouples used throughout this experimental program were purchased with calibration **certificates**.

A.3. Radiometers

Medtherm 64 series heat **flux** transducers were used to measure radiative heat transfer **during** the experimental program. The heat **flux** transducers were of the **Gardon** Gauge type and used **water** to cool the heat sink during experiments. The accuracy of these transducers quoted by the manufacturer is $\pm 3\%$ of the **full** ranges.

The **Gardon** gauge type sensor absorbs heat in a **thin** metallic **circular** foil, **transferring** heat radially to the heat sink. The temperature **difference** between the two points (heat sink and sensor) is proportional to the heat transferred and therefore proportional to the heat flux absorbed. At these two points the transducers have thermocouple junctions providing an **EMF** between the two output leads; the maximum voltage induced is typically 10 **mv** at **full** scale (though Medtherm quote a 150% over range capability for these units). **Certificates** of calibration for all heat **flux** transducer units show a direct linear **relationship** between **output** voltage and radiative heat.

The units consist of a pure copper body which is gold plated to protect against corrosion, contamination, and radiant heat absorption by the heat **sink**. A stainless steel flange is **also** provided for mounting **purposes** (see Figure A.8).

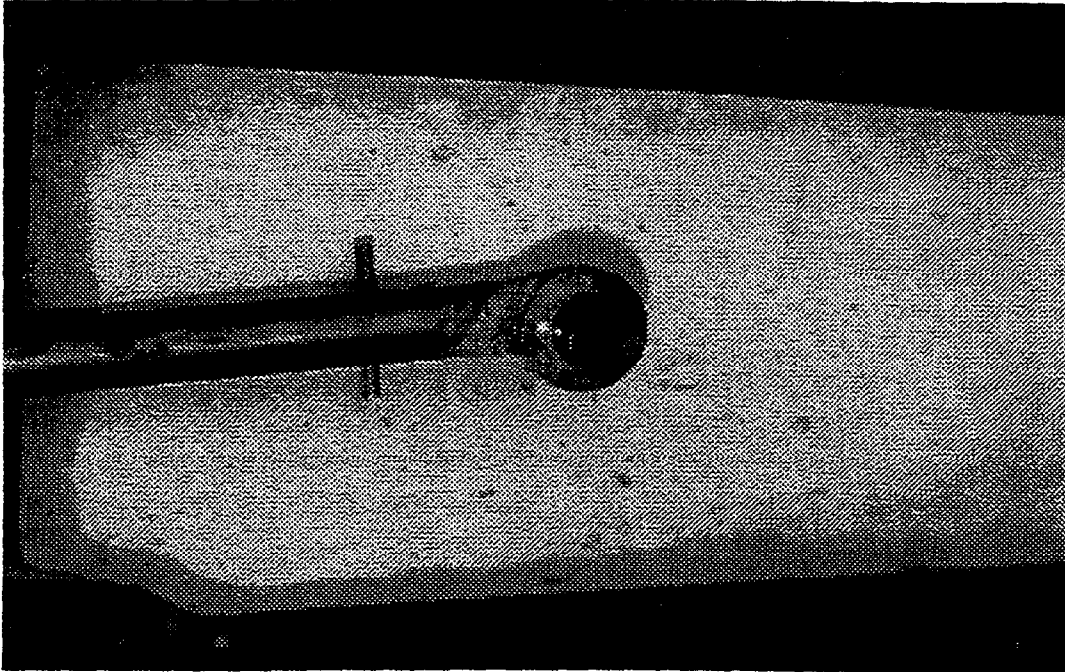

Figure A.8 Heat flux **transducer** (Radiometer).

A.4. Weighing Assembly

A **weighing** assembly was constructed **in** the Facility to measure the **fuel** mass hence enable the deduction of fuel burning rate in Room 102 during **fire** experiment. The assembly comprises of a **platform** supported by three load transfer rods to which load cells are connected to Room 1M02. The load platform consists of a **2.4m x 1.95m** skeleton made **from** 25 mm steel tube lined with a 4.5 mm compressed cement sheet floor. The dimensions and position of the **platform** floor in Room 102 are shown in Figure 3.6. The platform was stabilised by five thin stainless steel flexures mounted at three points to the floor and **platform**. Figure A9 shows a photograph of the weighing platform with a chair **frame** on top **after** a flaming fire burn.



Figure A.9 Weighing platform with a chair frame on top.

The load **from** the **platform** was transferred through three 8 mm diameter stainless steel rods (surrounded in 25 mm diameter stainless steel tubing and fibreglass insulation) to three load cells on the floor of level 1M (the rod passes through the ceiling of the bum room). The load **cells** were mounted to metal stands (Figure A 10). **The** load cells displayed a high standard of repeatability, creep control and also have high over load capacity.

The signals generated by the load sells were **transmitted** to a processing and display unit. This unit provided the stabilised excitation voltage required for the input to the load cells and the load cell signal output conditioning, processing and output display. The output was a 0 to ± 10 volt linear output corresponding to a **kilogram** scale of 0 kg to approximately 75 kg with a **resolution** of **2.5mV**, or **35g** in mass. The output **was** logged in real time by the data acquisition software.

The weighing assembly was calibrated prior to this experimental program using **N.A.T.A.** (National Association of Testing Authorities) calibrated masses.

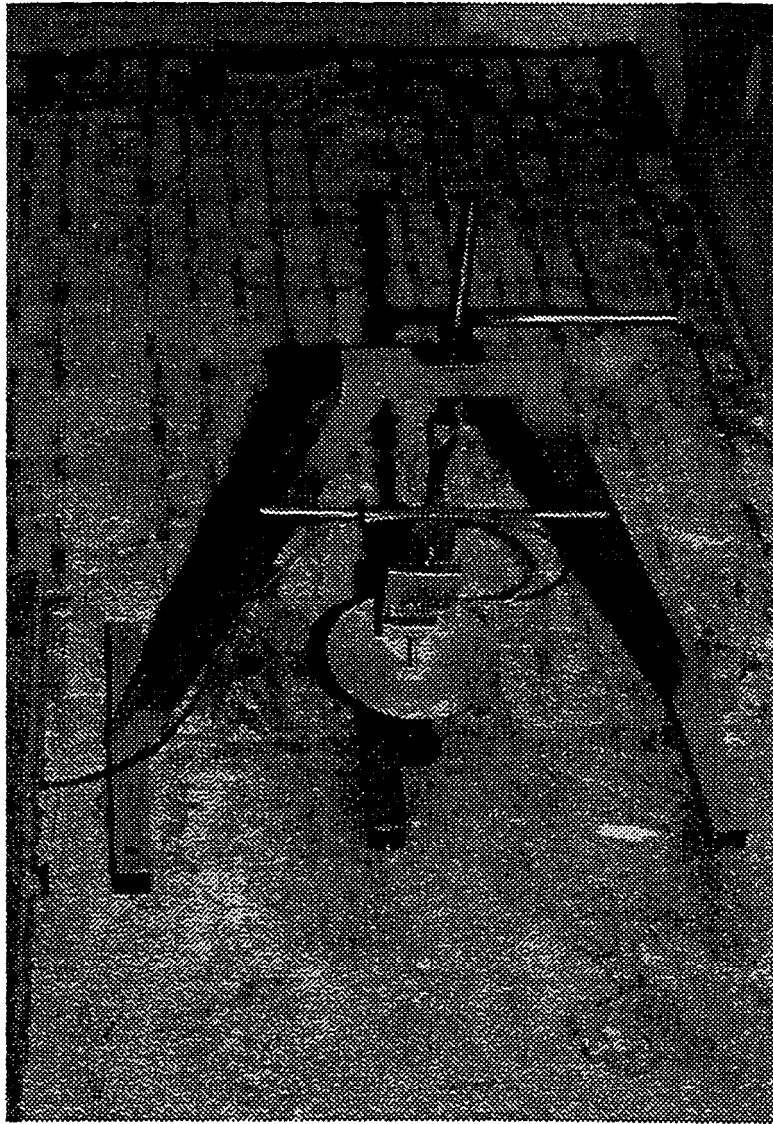

Figure A.10 Weighing system load cells and support assembly.

AS. Chemical Analysis Unit

A custom-built gas composition analysis unit (**Anri**) combined with other portable units was used to provide gas analysis throughout the EBFF. In most cases the gas input tubes (6 mm stainless tubing) were placed in high temperature **positions**. Custom **built** heat exchangers using copper coils within a water bath were used to reduce gas temperatures to near ambient levels. A small precipitation trap was incorporated at the base of the cooling coil to collect any condensation that may occur. **The** output of the heat exchanger was connected to a silica-gel moisture **filter** and then to the input of the gas analyser. The **first** four channels of the **Anri** unit provide analysis of **oxygen only**. The last channels analyse a combination of carbon dioxide, carbon monoxide and oxygen gases. Figure A 11 is a flow diagram of the chemical **analysis system**.

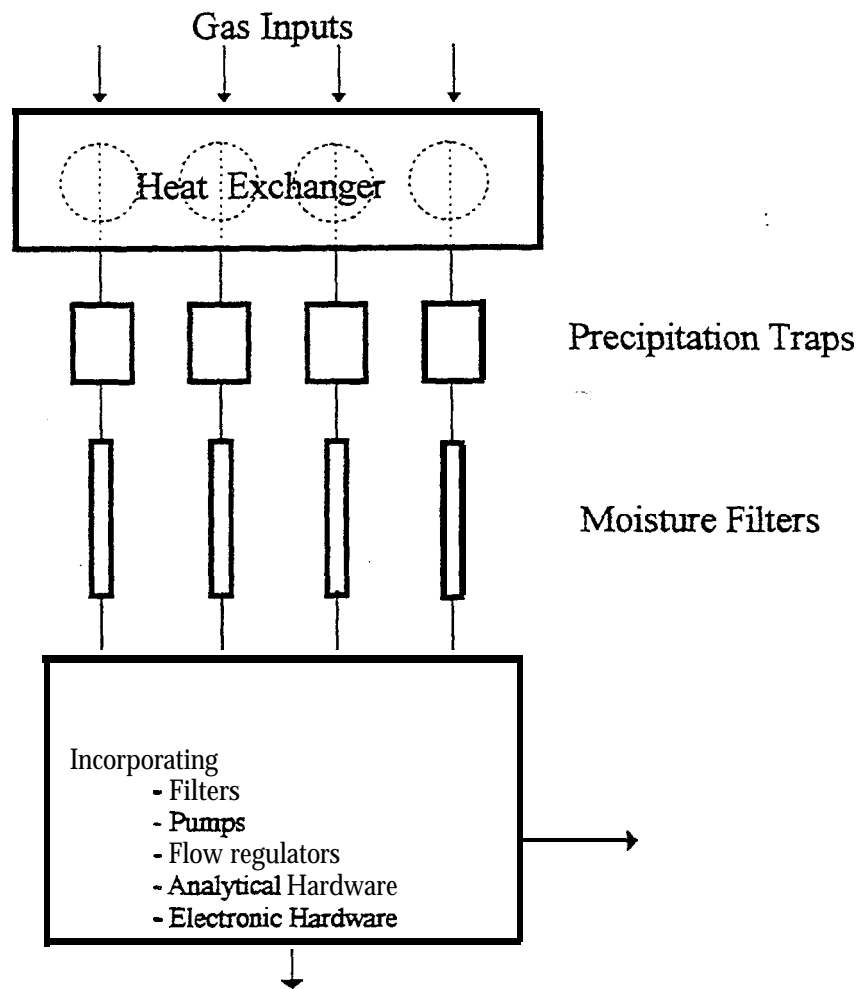

Figure A.11 Chemical analysis flow diagram

The fixed (ANRI) carbon monoxide and carbon dioxide transducers use an in&a-red optical bench with the **maximum** range of 0-5% and 0- 10% **repectivly** by volume. The portable CO transducers had a range of 0 - 1000 ppm The oxygen sensors were galvanic **cell** type with a range of 0-25% by **volume**.

The chemical analysis system was calibrated with a series of **known** concentration gas samples prior to the series of experiments. The T50 response time (time for output to reach 50% of input level for a stepped input) of each channel was measured by placing gas samples at the end of the gas intake tubes and monitoring the gas transducer outputs. Propagation delays were also measured (time for gas to travel through pick up tubes to the chemical analyser).

A.6. N-Directional Velocity Probes

Bidirectional sensor probes, originally developed by McCaffrey and Heskestad, were used in conjunction with differential pressure transducers to obtain velocity measurement through out the EBFF.

The McCaffrey probe is a simple and durable probe (Figure A 12) which overcomes major problems associated with traditional air velocity measurement in fires, such as soot concentrations and excessive gas temperatures. Due to the high melting point of stainless steel, the probes can resist the high temperatures associated with fires and remain robust throughout testing. The probe is also insensitive to flow direction. For example, Heskestad quotes that reasonable accuracy can be achieved for angles up to $\pm 50^\circ$ from the direction of the sensor probe. This insensitivity is due to the symmetric nature of the head; responding to flow in either direction. Also the relatively large size of the probe overcomes problems caused by water droplets (sprinkler activation) and soot (or debris) concentrations caused by fire experimentation.

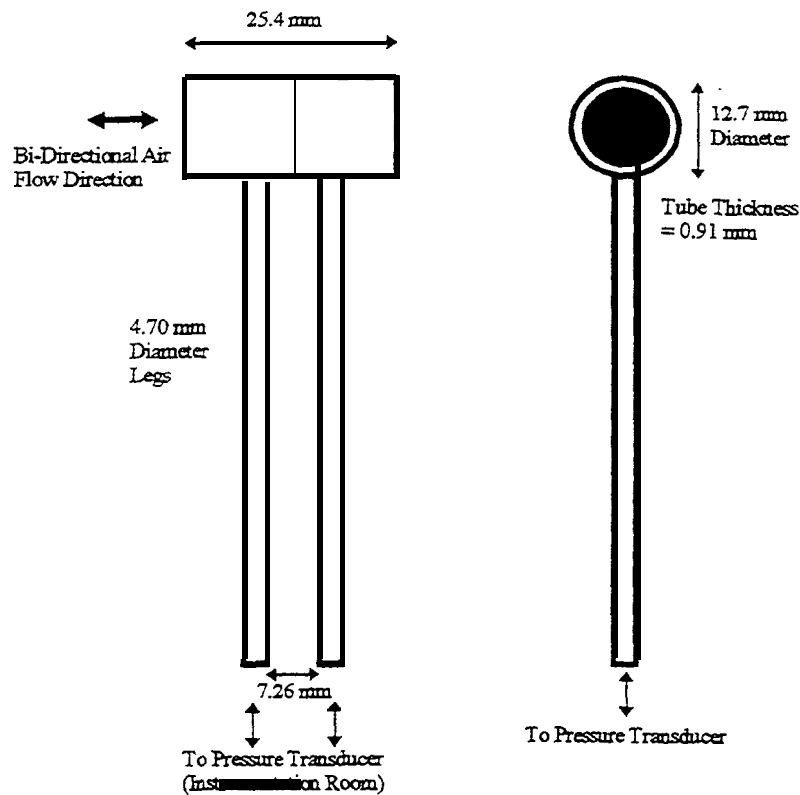

Figure A.12 McCaffrey velocity probe.

Veltron 5000A2 series and Furness series FC053 pressure transducers were used in conjunction with the two McCaffrey probes. The probes were calibrated to record velocities up to approximately 2 m/s (5 volts) at standard conditions. In the reduction of velocity readings, the variation in air density was taken into account.

A.7. Smoke Detectors

The smoke detectors used during the experimental program were commercially available ionisation and photo-optical type detectors. High sensitivity detectors were used within the **return** air duct **while** normal **sensitivity** detectors were used within the rooms. The interfacing between the smoke detection and the Δt_a acquisition system was achieved by sampling the output **from** the fire control panel located within the instrumentation van

A.8. Sprinkler

A pendant spray, 68°C bulb type sprinkler was located in the ceiling of the bum room. The sprinkler has a **nominal** bore of **10mm**. The sprinkler sub-system was not turned **on** during the experiments, the **fire** was allowed to grow **freely** without interruption of the sprinkler sub-system. However, the activation time of the sprinkler head was recorded during experimentation. This was achieved by attaching a trip **wire** around the bulb of the **sprinkler** head; when the **bulb** breaks, the trip wire is also broken, sending a signal to the data logging unit.

A.9. Video Recording

Video recording equipment **used** for the experimental program consisted of one **fixed** camera located in the Level I services room (Room 105, Figure 3. 1), and two portable camcorder located outside the building one facing the south side wall (or burn room), and the other looking down the length of level 1 corridor at an exit sign placed above door **D5**..

The camera **situated in** Level 1 services room had a **viewing** port cut through the plaster wall into room 101 and was protected by 2 layers of Boro-silicate glass. The portable CCD camera was made by Panasonic and has its output connected to, and recorded by, a Panasonic NV-FS90A super VHS recorder.

The unit used to record outside the building was a portable Panasonic NV-SM4A super VHS camcorder. Both recorder outputs were monitored **in** real time by two 14” Panasonic monitors located within the **instrumentation** and control room

A.10. Weather condition Monitor

The ambient conditions were measured before, during and after all experiments using a Weather Monitor II weather station.

The computerised weather monitoring station was used to provide **current** weather conditions and together with **its** internal data logging capability, provided previously recorded weather data. The weather station was used to record time, temperature, wind speed, wind direction, rainfall and barometric pressure. The recorded data was transferred using **PCLink** software to a personal computer creating a permanent data base of weather information.

The external temperature and wind speed/direction sensors were mounted at a location approximately 17 meters south of the EBFF **bum room window**. These sensors were located approximately 5 meters **from** ground level, and were connected to the data acquisition and control room

A.11. Data Logging System

The data logging system comprised a number of hardware and **software** components. A block diagram of the system is provided in figure A.15. The functions -of the hardware and **software** are discussed below.

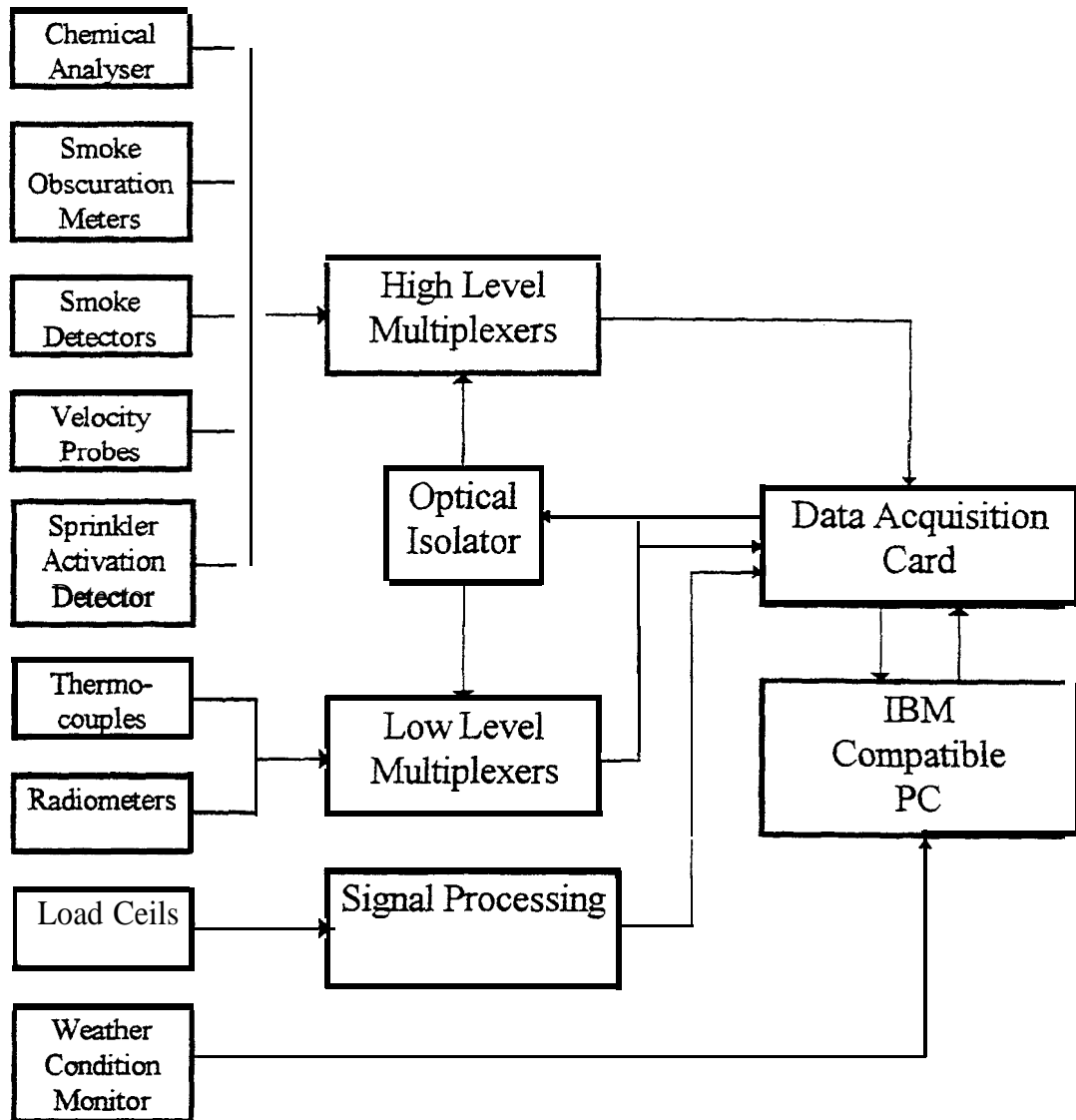

Figure A.15 Data logging system block diagram

A 11.1 Data Acquisition Hardware

The custom-built multiplexers high gain **differential** instrumentation amplifiers, provide high quality linear amplification. Each multiplexer also monitors **amplifier** gain and **amplifier**.

The **multiplexers** were controlled with a 5 bit digital control line, enabling switching through 32 channels. The typical switching rate was at 32 **Hz**. The outputs of the **multiplexers** are bidirectional and have a voltage range of ± 5 volts.

The six low level multiplexers each had 24 thermocouple inputs and 5 radiometer inputs. These multiplexers provide a typical amplification gain of 100. The multiplexer inputs were **fully** isolated, bidirectional and **differential**. Another channel was provided for cold junction **isothermic** temperature reference point monitoring. **The** cold junction reference was fully self contained within the multiplexer itself

The **two** high level multiplexers each had 30 general purpose 5 volt bidirectional **differential** inputs. These multiplexers provided a selectable amplification gain of 1 or 10, in the current case the multiplexer used had a gain of 1. The output was ± 5 volts.

Data acquisition and control was accomplished by the use of an IBM compatible PC with the following hardware configuration:

- 486 DX 50 Processor, **AMI** BIOS
- 8 Megabytes of RAM
- 120 Megabytes Hard Disk Drive capacity
- Super VGA Graphics adaptor card and 14" Monitor
- **PC-LabCard** PC-8 14 **Modulized** Data Acquisition Card

The PC-814 is a 14-bit **multi-purpose** data acquisition system card. It **included** an analog to **digital** converter, digital to analog converter, counter/timer as well as all hardware required to data logging and PC interfacing. Up to 16 input channels were available for differential analog input. **Of these** only nine channels were used for this series of tests. Eight channels were used as **multiplexer** inputs. One channel was used for mass loss logging. One digital output was used to switch all of the multiplexers in parallel with each other. Switching occurred via an optical isolator which was used to provide an electrically isolated earth; this was implemented to reduce noise and earth loops associated with common earthing of **different** devices.

The data logging card was capable of operating at a maximum **frequency** of 100 **kHz**. The input range is software programmable. A range between 0 to 10 volts was selectable when used **with uni-directional** inputs. A selectable range between 0 to ± 5 volts was available using bi-directional inputs.

All.2 PC Software Overview

The data logging software operated under Microsoft Windows version 3.1 running under MS-DOS version 6.0. The hardware data acquisition card was driven by a data acquisition package, Labtech Notebook X/E version 7.1.1W, which was capable of real-time data acquisition, real time graphing and display as well as real-time calculations performed on incoming data. The data was stored directly on the hard disk in binary format. Each reading was time stamped with a progressive time interval relative to the test start time.

A.12. Data Processing Scheme

As discussed previously, the Experimental Building-Fire Facility was equipped with instruments to measure temperature, radiation, gas composition, smoke optical density and soot concentration. The measured data were collected using a PC-based data logger via eight multiplexers. Eight separate binary data files were created for these eight multiplexers during experiments. There were 32 channels (0 to 31) in each multiplexer. The input of each channel was connected to a particular sensor and the output was digitised voltage which was stored in binary format. The data analysing system identified separate channels from the eight files, read and converted the binary data into appropriate physical quantities. To avoid the effects of electronic noise of the measurement, the measured raw data were averaged over 12 sampled readings.

A 12.1 Temperature

Temperatures were measured by means of Nickel-Chromium, Nickel Aluminium ("K" type) thermocouples and recorded in the first 44 channels of each of six low level multiplexers in volts. As mentioned in the previous section, there were three additional channels in each multiplexer for de correction of temperature conversion; namely, Channel 29 for cold junction isothermic temperature reference point, Channel 30 for the determination of the amplifier offset within the multiplexer, and Channel 31 for the dynamic amplifier gain.

The conversion was based on the International Practical Temperature Scale of 1968 (IPTS68). The practical conversion of the measured temperature can be expressed as follows:

1. Calculate the reference temperature point

$$T_{\text{ref}} = r(29) * 10.0$$

where $r(29)$ is the readings stored (reference temperature) on channel 29.

- Convert the reference temperature to reference EMF (V_{ref})

$$V_{ref} = \sum_{j=0}^n a_j T_{ref}^j$$

where V_{ref} is in millivolts and T_{ref} is in $^{\circ}C$; n is the order of polynomial function coefficients a_j ($j=0, \dots, n$) are listed in Table A3. The

Table A.3 Polynomial Coefficients for Computation of Thermocouple EMF as a Function of Temperature.

Temperature Range ($^{\circ}C$)	0 – 1372 $^{\circ}C$
a_j	-1.8533063273e-2 +3.8918344612e-2 +1.6645154358e-5 -7.8702374448e-8 +2.2835785557e-10 -3.5700231258e-13 +2.9932909136e-16 -1.2849848798e-19 +2.2239974336e-23

- Calculate the amplifier gain

$$\text{gain} = (r(31) - r(30))/0.045$$

where $r(31)$ is the readings **on channel 31 (gain channel)** and $r(30)$ is the readings on channel 30 (**offset channel**). The values of gain are around 100.

- Compute the real thermocouple readings of separate channel

$$V = (r(i) - r(30))/\text{gain}$$

where i varies 0 to 23, and V is in volts; $r(i)$ is the readings on channel i

- Convert the voltage readings to temperature $^{\circ}C$

$$T = \sum_{j=0}^n C_j V^j$$

where V is in micron volts and T is in $^{\circ}C$. The coefficients C_j are listed in Table A4.

To compare with the NRCC model prediction, the measured temperatures in the bum room (44 thermocouple positions located at four different elevations, along the longitudinal centreline of the bum room) were spatially averaged. It was found that there was little difference in the results for the spatially average was based on either one, two, three or four rows of thermocouples. The averaged temperature is used to represent the hot layer temperature.

Table A.4 Coefficients of the Power Series Expansions for Thermocouple "K".

Temperature Range (°C)	0-280	280 – 1300
C_j	0.000	+7.45
	+2.5345e-2	+2.23148e-2
	-3.439e-7	+3.3631e-7
	-1.88e-12	-2.43219e-11
	+1.2582e-14	+7.66105e-16
	-1.4365e-18	-1.09973e-20
	+4.695e-23	+6.12544e-26

A 12.2 Radiation Heat Flux

Eight Medtherm 64 series Heat Flux Transducers were used to measure the radiation heat flux. The outputs of the measurement are in millivolts with a maximum of 10 mv. A direct linear relationship was applied to all the transducers to convert to heat fluxes with different coefficients.

$$q = 1000 * r(i) * C_{rad} .$$

where q is in kW/m^2 and $r(i)$ readings in Volts and C_{rad} is a conversion coefficient listed in Table A.5.

Table A.5 Radiation Heat Flux Conversion Coefficient C_{rad}

Radiometer ID	Capacity (kW/m^2)	C_{rad}
HF01	56.77	6.72
HF02	113.54	11.41

APPENDIX B

SMOKE

CERTIFICATE



File: FD30-038

Contact: Peter Haggar (03) 9248 4931

Mr Ian Moore.
Centre for Environmental Safety and Risk Engineering
Victoria University of Technology
P O Box 14428
MMC
Melbourne Vic 3000

Dear Sir,

TESTING OF VUT SMOKE DETECTORS

Report xf1106/R1

The Victorian University of Technology submitted two smoke detectors for sensitivity testing to SSL. One smoke detector was a Hochiki, model SIH-AM, ionisation type smoke detector with serial number 30920101. The other smoke detector was an Olsen, model P24B, optical type smoke detector with serial number 226245. The smoke detectors were to be exposed to one sensitivity test only.

Both detectors were labelled with a red doth, indicating that they are high sensitivity detectors. The sensitivity range for ionisation type smoke detectors of high sensitivity, such as the Hochiki model SIH-AM, is from 0.10 MIC X to 0.35 MIC X. The sensitivity range for optical smoke detectors of high sensitivity, such as the Olsen P24B, is from 3% to 12% obscuration.

Both smoke detectors appeared to have been used and had brown tarnished spots on one side.

The two smoke detectors were tested, in accordance with the requirements and conditions of AS 2362.17-1 993. Testing was conducted on 1 September 1995.

The Hochiki SIH-AM detector alarmed at 0.17 MIC X and the Olsen alarmed at 5% Obs/m. Both detectors operated within the designated sensitivity for a high sensitivity device.

If you require further testing information please contact the undersigned.

Yours faithfully,

A handwritten signature in black ink that reads 'Peter Haggar'.

Peter Haggar
Materials Scientist
(Fire Systems)
6 November 1995

Q1831106.rep

SCIENTIFIC SERVICES LABORATORY
177 Salmon St. Port Melbourne, Vic. 3207 Telephone (03) 9248 4900 Fax (03) 9646 5165

A Business Unit of Australian Government
Services



APPENDIX C

**AIR HANDLING/SMOKE CONTROL COMMISSIONING
REPORT**

Centre for Environmental Safety and Risk Engineering

Fiskville Fire Test Facility

Test-Adjust-Balance Report

21 July 1995

Ben white

Bruce Penglis

The aim of this brief test was to set up the air handling systems installed at CESARE's fire test facility after recent modification to provide predetermined air flow quantities. Also, this required that the system be overlooked to ensure proper operation. Equipment used included a flowhood to cover a 300mm x 300mm square face diffuser, a Pacer industries DTA4000 digital anemometer (calibrated 7/11/92), a Clipsal clip on ammeter, and a Setra C264, ± 625 Pa differential pressure transducer (4-20 mA output).

Theory

The determination of air supply rates was done in light of several methods available. The class of occupancy; residential, requires basic ventilation rates to be produced - 6 air changes per hour. General check figures for such an occupancy class are based on the general requirement unless a particular operation requires higher heating or cooling, (i.e. high equipment load). Cooling load calculations are generally not done for this application, though in this instance preliminary estimates were conducted using Temper (load estimation program).

Table 1 Cooling load calculations for various conditioned areas. Loads are for one level only.

Room	101	102	103	104	Corridor
Conditioned room combination	Load V (l/s) (W)	Load V (l/s) (W)	Load V (l/s) (W)	Load V (l/s) (W)	Load V (l/s) (W)
Rooms 101, 102, 103, and 104	935 78	1212 101	446 37	835 70	-
Rooms 101, 102, 103, and corridor	899 75	1246 104	435 36	- -	1891 158
6 air changes/hr (4.2 l/s/m ²)	- 56	37	- 44	- 56	- 92
5.0 l/s/m ²	- 67	44	- 52	- 67	- 109
Final Design	2 x 35	45	50	2 x 35	50

- ☐ Loads are peak loads as calculated at December
- ☐ Loads are calculated for level one; hence small variations may exist for levels 1M and 2.
- ☐ All calculations done using program TEMPER.

Values were chosen in the final design figures which satisfied most design criteria listed above. Cooling load values for room 102 are high because Temper takes into account absorbance of heat by the floor from incident heat via windows; since room 102 has a large window area, the result is quite high. In reality, this load would be counteracted by curtains or blinds, thus not requiring the air conditioning plant to cater for this load - it is justified to lower to flow requirement closer to a general design value of 5.0 l/s/m². The corridor on the other hand would normally have an additional two or three outlets because of its length. Based on this assumption, and observation of cooling loads, a design figure of 50 l/s per outlet was chosen (only one outlet currently installed).

Method

After ensuring that the air supply system was operating correctly, the appropriate operating conditions were set up as would be required for normal operation of the units.

- supply air dampers to all levels fully open via control panel
- return air dampers from all levels fully open via control panel
- normal cycle operation (not economy cycle-100% outside air)
- both supply air fans switched on high from distribution board
- bypass dampers set to around 50% initially, ie. prior to any supply outlet measurements
- all supply air outlets connected, joints sealed, diffusers installed, and opposed blade dampers open (checked because of recent installation).

Once the operation had been set up correctly, base measurements were taken to observe the gross air supply quantities. A flowhood was constructed, and used in conjunction with a wind vein anemometer to measure air flow rates.

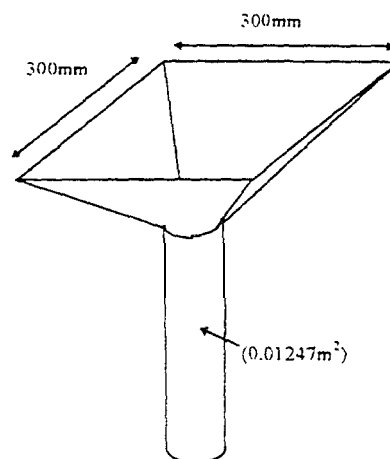

Figure 1 Flowhood construction

Initially, after making preliminary measurements to most outlets within the supplied floors (levels 1, 1 M, and 2), the air supply quantities has to be altered. It was eventually found that supply air fan 1 (supplying level 2) had to be set to 47% bypass, while supply air fan 2 was set to 70% bypass (levels 1 and 1M).

The flow velocity was measured by taking an observed average reading from the displayed flow velocity on the anemometer. Obviously, fluctuations occur due to boundary flow conditions, and fluctuations in fan performance during operation (turbulent flow regime in supply air ducts),

Two runs were conducted where the flow rates out of each damper were adjusted by changing the angle of opposed blade dampers at each diffuser outlet. The first run was to set each outlet within close proximity of the design values, and the final run to increase the accuracy of the flow rates produced. Prior to establishing the correct bypass arrangement for each supply air fan, several preliminary runs were conducted in order to get gross supply rates to each outlet as required.

Once flow velocities were of satisfactory nature, results were recorded as given below.

Results

Table 1 Air supply rate results

	Diffuser Location						Net
Level 1	101D	101W	102	103	Corr		
Av velocity	2.81	2.83	3.65	4.01	4.08		
Flow (l/s)	35	35	46	50	51		
Design	35	35	45	50	50		217
Level 1M	1M01D	1M01W	1M02	1M03	1M04D	1M04W	
Av Velocity	2.82	2.82	3.62	3.65	2.78	2.84	
Flow (l/s)	35	35	45	46	35	35	
Design	35	35	45	50	35	35	231
Level 2	201 D	201 w	202	203	204 D	204 W	
Av Velocity	2.80	2.83	3.60	3.95	2.81	2.83	
Flow (l/s)	35	35	45	49	35	35	
Design	35	35	45	50	35	35	234

∅ Supply air fan 1 total air 234 l/s (70% bypass)

∅ Supply air fan 2 total air 448 l/s (47% bypass)

Table 2 Motor current

Motor current	Phase	Phase	Phase
	1	2	3
SAF 1	2.5	2.2	2.0
SAF 2	2.0	2.5	2.0

Conclusion

The air supply system was satisfactorily commissioned to supply air flow rates as show above in results. Relatively high accuracy was achieved by small changes in opposed blade dampers and bypass arrangements. It is suggested that after the completion of any significant fire experiments that diffusers in the vicinity which are prone to heat damage should be quickly checked to ensure correct flow rates (heat may affect opposed blade damper position).

APPENDIX D

FIRE STATISTICS USED IN THE DEVELOPMENT OF THE EXPERIMENTAL PROGRAM

TABLE 1
PERCENTAGE CLASS 2 & 3 FIRES
(CSIRO)

TIME PERIOD	% RESIDENTIAL FIRES OF TOTAL No. FIRES	% CLASS 1 OF TOTAL RESIDENTIAL FIRES	% CLASS 2&3 OF TOTAL RESIDENTIAL FIRES	% CLASS 2&3 OF TOTAL FIRES
1989 - 1990	58.1	77.2	22.2	12.8
1990 - 1991	57.7	75.2	21.5	12.4
1991 - 1992	59.2	61.0	36.2	21.4

TABLE 2
AREA OF FIRE ORIGIN
(Fires Initiating In Area As % Of Fires For Each Class)
(CSIRO)

AREA	CLASS 1			CLASS 2&3		
	1989-1990	1990-1991	1991-1992	1989-1990	1990-1991	1991-1992
Lounge	13.6	14.4	13.4	6.9	8.3	8.4
Bedroom	13.8	15.3	14.5	15.2	15.3	17.0
Kitchen	33.0	30.3	34.4	34.7	33.9	36.9
Trash Rubbish	0.26	0.3	0.2	9.5	9.4	6.2
Chimney	8.2	7.0	5.8	0.9	0.9	1.1
Structural Area	7.7	8.3	7.4	3.5	2.3	2.1
Closet	0.69	0.9	0.8	0.9	0.6	1.5
Laundry	6.3	5.8	4.9	5.6	4.5	5.2

TABLE 3
IGNITION FACTOR
 (% Fires Within Each Class)
 (CSIRO)

IGNITION FACTOR	CLASS 1			CLASS 2 & 3		
	1989-1990	1990-1991	1991-1991	1989-1990	1990-1991	1991-1999
Unattended	15.4	14.3	16.0	17.1	16.4	21.8
Accidentally Turned On	4.5	3.3	3.9	3.5	3.6	3.5
Short Circuit	10.4	10.6	9.8	8.2	8.5	7.8
Electrical Failure	5.4	4.9	5.0	4.5	3.9	4.0
Lack Maintenance	5.8	6.0	5.0	2.8	1.6	1.6
Discarded Material	3.4	3.1	3.6	15.2	13.1	11.8
Falling asleep	1.6	1.5	1.4	5.7	4.6	4.9
Children	4.2	4.3	4.2	3.2	3.7	3.9
Combustible To Close	4.6	5.0	5.0	3.8	3.1	4.5

TABLE 4
EQUIPMENT INVOLVED IN IGNITION
 (% Of Fires Within Each Class)
 (CSIRO)

EQUIPMENT INVOLVED	CLASS 1			CLASS 2 & 3		
	1989-1990	1990-1991	1991-1992	1989-1990	1990-1991	1991-1992
Indoor Fireplace	6.2	5.5	4.2	0.67	0.7	1.3
Fixed Heating	4.5	4.0	4.1	1.5	1.2	1.6
Fixed Cooking Surface	19.5	17.1	19.5	21	19.4	24.8
Fixed Oven	3.7	3.7	4.2	3.7	3.2	3.3
Portable Heating Unit	2.7	3.1	2.5	3.0	3.0	2.7
Chimney	4.4	4.0	3.0	0.4	0.3	0.3
Fixed Wiring	2.3	2.1	1.8	1.5	1.2	0.9
Dryers	1.9	1.5	0.06	2.8	1.8	0.1
Wash Machine	2.0	2.1	1.4	1.8	1.6	1.0
Portable Appliance Controlled heat	2.0	1.8	0.7	1.6	1.6	0.4

TABLE 5
FORM OF MATERIAL IGNITED FIRST
 (% Of Fires within Each Class)
 (CSIRO)

FORM OF MATERIAL	CLASS 1			CLASS 2 & 3		
	1989 - 1990	1990 - 1991	1991 - 1992	1989 - 1990	1990 - 1991	1991 - 1992
Structural Member	3.7	3.4	2.8~	1.1	0.6	0.5
Furniture (All types)	5.8	6.2	5.6	5.3	6.7	6.6
Mattress, Pillow, Bedding	6.5	6.6	6.3	10.0	8.9	10.1
Curtains	1.1	1.1	1.4	0.9	0.9	0.9
Paper	1.2	1.4	1.5	1.9	2.3	3.3
Wire Insulation	14.7	13.8	12.7	12.3	11.6	10.6
Rubbish	6.9	6.9	5.3	16.2	14.8	13.2
Cooking Materials	20.5	17.8	21.8	24.2	24.9	30.2

TABLE 6
TYPE OF MATERIAL IGNITED FIRST
 (% Of Fires Within Each Class)
 (CSIRO)

MATERIAL	CLASS 1			CLASS 2 & 3		
	1989 - 1990	1990 - 1991	1991 - 1992	1989 - 1990	1990 - 1991	1991 - 1992
Fat / Grease	17.6	14.7	17.7	18.4	16.0	20.4
Plastics (All Types)	16.8	18.0	15.7	15.0	14.9	15.1
Polyvinyl	11.7	11.5	10.4	9.9	10.2	8.7
Sawn Timber	7.4	7.1	6.4	2.0	1.3	1.9
Paper	4.5	5.2	4.7	10.9	14.0	11.5
Cotton	4.2	4.8	4.9	8.5	6.1	9.7
Man Made Fabric	3.4	3.1	3.0	4.3	4.2	4.8
Food, Starch	3.4	3.1	3.7	6.0	8.4	8.8

TABLE 7
CAUSES OF FIRES AND DIRECT PROPERTY DAMAGE
FOR HOTEL AND MOTELS (1988-1992)
(NFPA)

FIRE CAUSE	No. FIRES %	PROPERTY DAMAGE %
Smoking Materials	19.4	9.3
Incendiary	19.3	25.7
Cooking equipment	13.4	6.8
Heating Equipment	9.0	14.2
Electrical Distribution	8.2	13.7

TABLE 8
CAUSES OF FIRES AND DIRECT PROPERTY DAMAGE
FOR APARTMENTS (1988-1992)
(NFPA)

FIRE CAUSE	No. FIRES%	PROPERTY DAMAGE %
Smoking Materials	10.2	9.2
Incendiary	15.4	25.7
Cooking equipment	34.7	11.1
Heating Equipment	5.4	5.6
Electrical Distribution	5.0	8.2

TABLE 9
AREA OF ORIGIN AND PROPERTY DAMAGE
FOR APARTMENTS (1988-1992)
(NFPA)

AREA OF ORIGIN	No. FIRES %	PROPERTY DAMAGE %
KITCHEN	43.7	13.3
BEDROOMS	15.1	33.4
LIVING ROOMS	8.5	33.5

TABLE 10

MATERIAL OR ITEM MAINLY RESPONSIBLE FOR
FIRE DEVELOPMENT IN DWELLINGS
(UK HOME OFFICE STATISTICS)

MATERIAL, ITEM MAINLY RESPONSIBLE FOR FIRE DEVELOPMENT	1989	1990	1991	AVERAGE
Bedding	4.4	4.6	4.5	4.5
Upholstery, Covers	6.9	6.8	6.7	6.8
Internal Fittings	2.2	2.3	2.5	2.33
Other furnishings and furniture	0.9	1.0	0.9	0.93
Fat	26.0	32.6	26.0	28.2
Wall Partitions	0.8	0.87	0.89	0.85
Ceiling Linings	0.52	0.43	0.46	0.47
Flooring	1.5	1.6	1.6	1.56
Curtains, Blinds	1.1	1.1	1.2	1.13

REFERENCES

1. "Australian National Fire Incident Statistics 1989 - 1990", Technical Report 92/5, CSIRO Division of Building, Construction and Engineering, October 1992.
2. "Australian National Fire Incident Statistics 1989 - 1990", Technical Report , CSIRO Division of Building, Construction and Engineering,
3. "Selections From The U.S. Fire Problem Overview Report Through 1993, Leading Causes And Other Patterns And Trends, Hotels And Motels, And Apartments", Hall, J. R., NFPA, 1995.
4. Fire Statistics UK Home Office, 1989, 1990, 199 1

APPENDIX E

1. **SMOULDERING FIRE EXPERIMENTS**

1.1 **COMMERCIAL**

1.1.1 **Single Inner Spring Mattress**

Mattress

2X, 19 peel foam, density 20 km/m³, 1.26 kg per sheet,
2.52 kg.

2X, Garneted and 1.25kg/m², 2.5 kg each, total weight 5
kg.

2X, Garneted and 1.25 kg/m², 2.5kg each, 5 kg.

1X, Cotton print 8g.

Pillow

Latex foam rubber pillow with cotton 1.08 kg.

Total Combustible Mass : 13.6 kg

1.1.2 **Mattress**

Mattress

Polyurethane cotton 4.0 kg.

Pillow

Latex foam rubber pillow 1.08 kg.

Total Combustible Mass : 5.08 kg.

1.13 Single Lounge Chair

Pine frame, 9 kg
Particle board seat frame, 2.4 kg
Ply arms, 3.7 kg
Polyurethane H30-100), 2.1 kg
kg
100 % cotton fabric, 1.5 kg
0.1 kg

Total Combustible Mass : 21.4 kg

1.2 FIRE SIMULATION EXPERIMENTS

1.2.1 Simulated Lounge Chair

Back - Grade A23-130, weight 1.16 a 40%
cotton 60% linen cover
Seat - A23-130, kg with a 40%
cotton 60% linen cover

Total Combustible Mass : 2.71 kg 4 0.2 kg

2. SMALL ROOM FIRE EXPERIMENTS

2.1 COMMERCIAL PRODUCT EXPERIMENTS

2.1.1 Single Lounge Chair

Pine frame, 9 kg
Particle board seat frame,
Ply arms, 3.7 kg
Polyurethane foam
kg
100 % cotton fabric, 1.5 kg
0.1 kg

Total Combustible Mass : 21.4 kg

23 SMALL ROOM **FIRE SIMULATION** EXPERIMENTS

2.2.1 Kitchen Fire

Standard 1.84 kg
 Timber 35kg
 Plaster
 2.9kg
 6.5kg

2.2.2 Simulated Lounge Chair

a. - FMS8

Back - A23-130, weight 2.4kg with a 40%
 cotton 60% linen cover
 Seat - Polyurethane A23-130, a 40%
 cotton 60% linen cover

Total Combustible Mass : 5.08 kg (refer to Table 1)

b. Experiment FMS 10

load configuration

as that adopted for the
 Section 1.2 of this Appendix.

Table 1: Fuel Load for Small Room Flaming Fires

Test ID	Fuel Load kg	Total Fuel Load kg
FMS4	4.12 P/U 1.10 Cotton/Linen	5.22
FMS5	3.76 P/U 1.18 Cotton/Linen	4.94
FMS6	3.88 P/U 1.04 Cotton/Linen	4.92
FMS7	3.86 P/U 1.06 Cotton/Linen	4.92
FMS8	3.98 P/U 1.1 Cotton/Linen	5.08
FMS10	1.90 P/U 0.82 Cotton/Linen	2.72

3. LARGE ROOM FIRE EXPERIMENTS

3.1 COMMERCIAL PRODUCT EXPERIMENTS

3.1.1 Double Inner Spring Mattress plus Base

Mattress

2X, 6 density 20 kg/m³, kg

2X, 16 polyurethane peel foam, density
1.65 kg.

2X, Garneted and needled cotton kg/m², 2.5kg each,
7.2 kg.

2X, Thermally bonded polyester fibre,

Convolutud Polyurethane sheet foam 27 kg/m³, 2.13kg

1X damask kg

2X, sheet kg/m³, 0.77 kg

Base

weight 15 kg

1X, Cotton print 5 g kg.

Pillow plus coverings

rubber pillow cover, weight 1.28 kg

1X, Doona, 1.62 kg

cover plus sheets, 50% polyester 50% cotton, 1.8 kg

Total Combustible Mass : 34.06 kg

3.1.2 Double Polyurethane Mattress

Mattress

cotton kg

Pillow plus coverings

2X, Dacron rubber pillow with cotton 1.28 kg

1X, Doona, 1.62 kg

1X, plus sheets, 50% polyester 50% cotton, 1.8kg

Total Combustible Mass: **12.62kg**

3.1.3 Three Seater Couch

13kg
Particle board seat kg
Ply arms,
Polyurethane 100), 7.5 kg
Dacron, 5.87 kg
100
Elastic webbing, 0.3 kg

Total Combustible Mass: 41.82 kg

3.2 FIRE SIMULATION EXPERIMENTS

3.2.1 Simulated 3 Seater Couch

Back - Grade A23-130, weight 2.28kg with a 40% cotton
60% linen

Seat - Polyurethane A23-130, weight with a 40% cotton
60% linen cover weight 1.72 kg

Total Combustible Mass: 9.42 kg (except for **FMS4** - Total Mass: 9.22 kg)

Fig. 6.1 .1-1
Commercial product tests (smouldering)

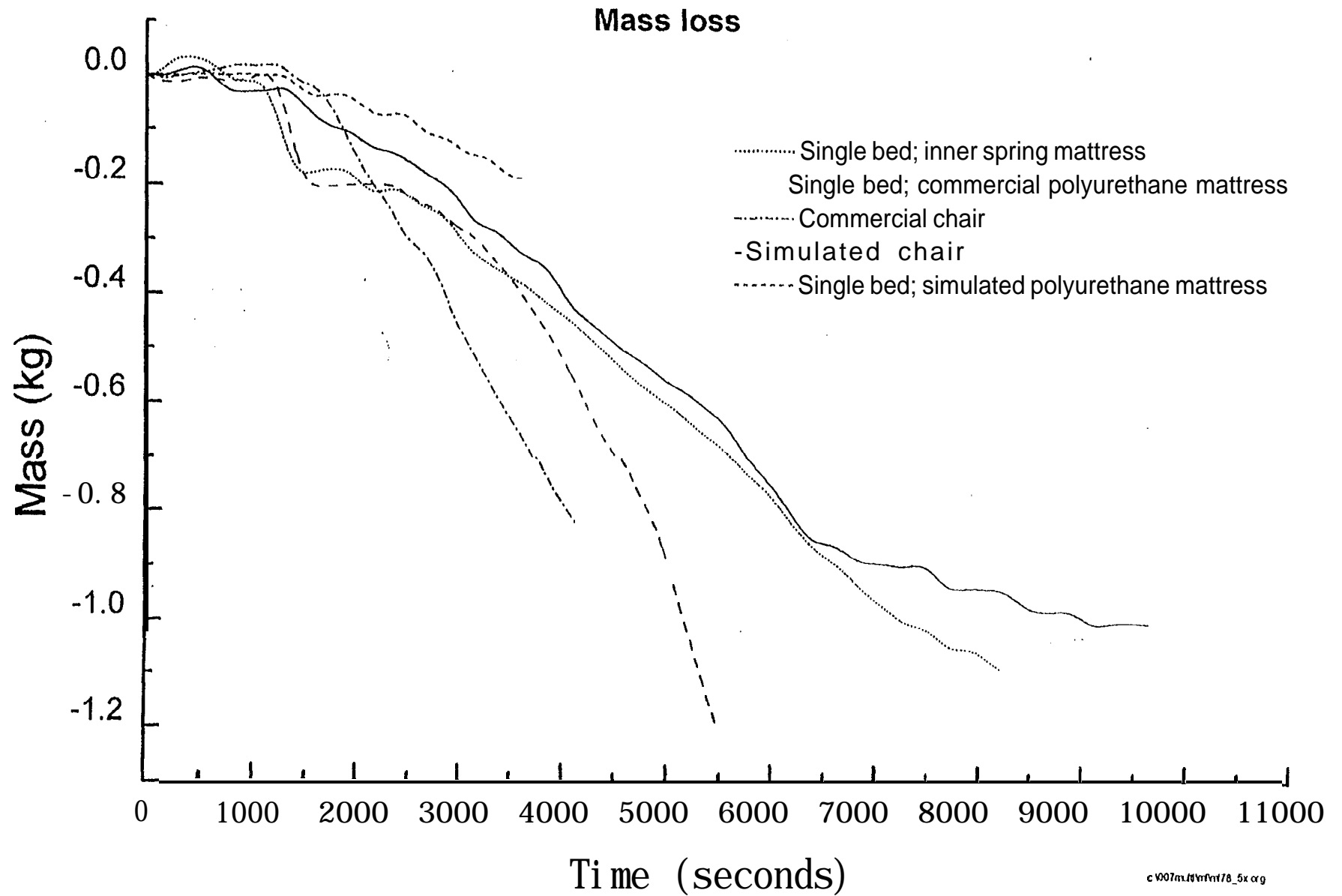

Fig. 6.1.2-1
Commercial product tests (smouldering)

Carbon monoxide concentration at top of room 102 door

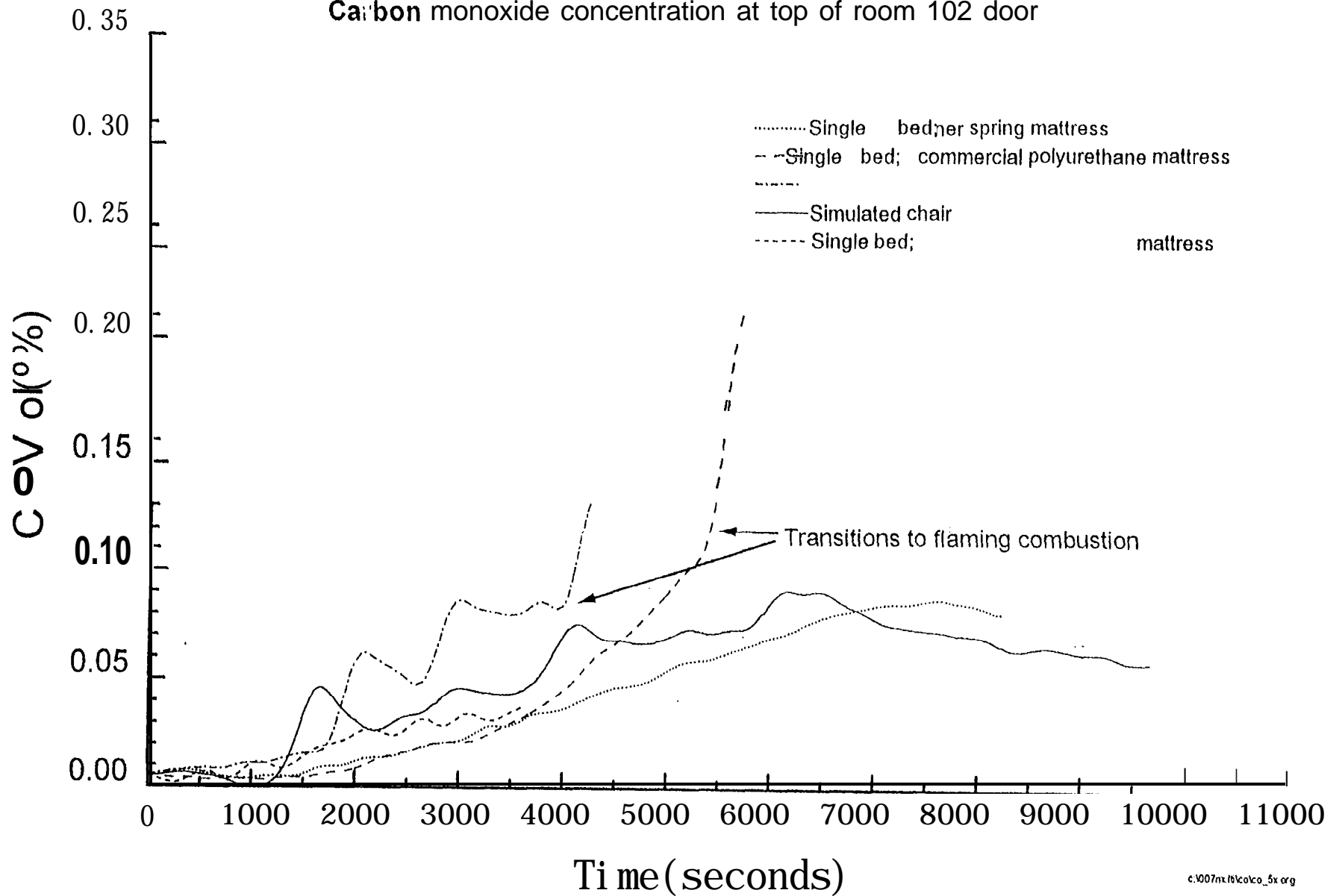

Fig. 6.2.1-I
Mass loss (smouldering) - Test SM1

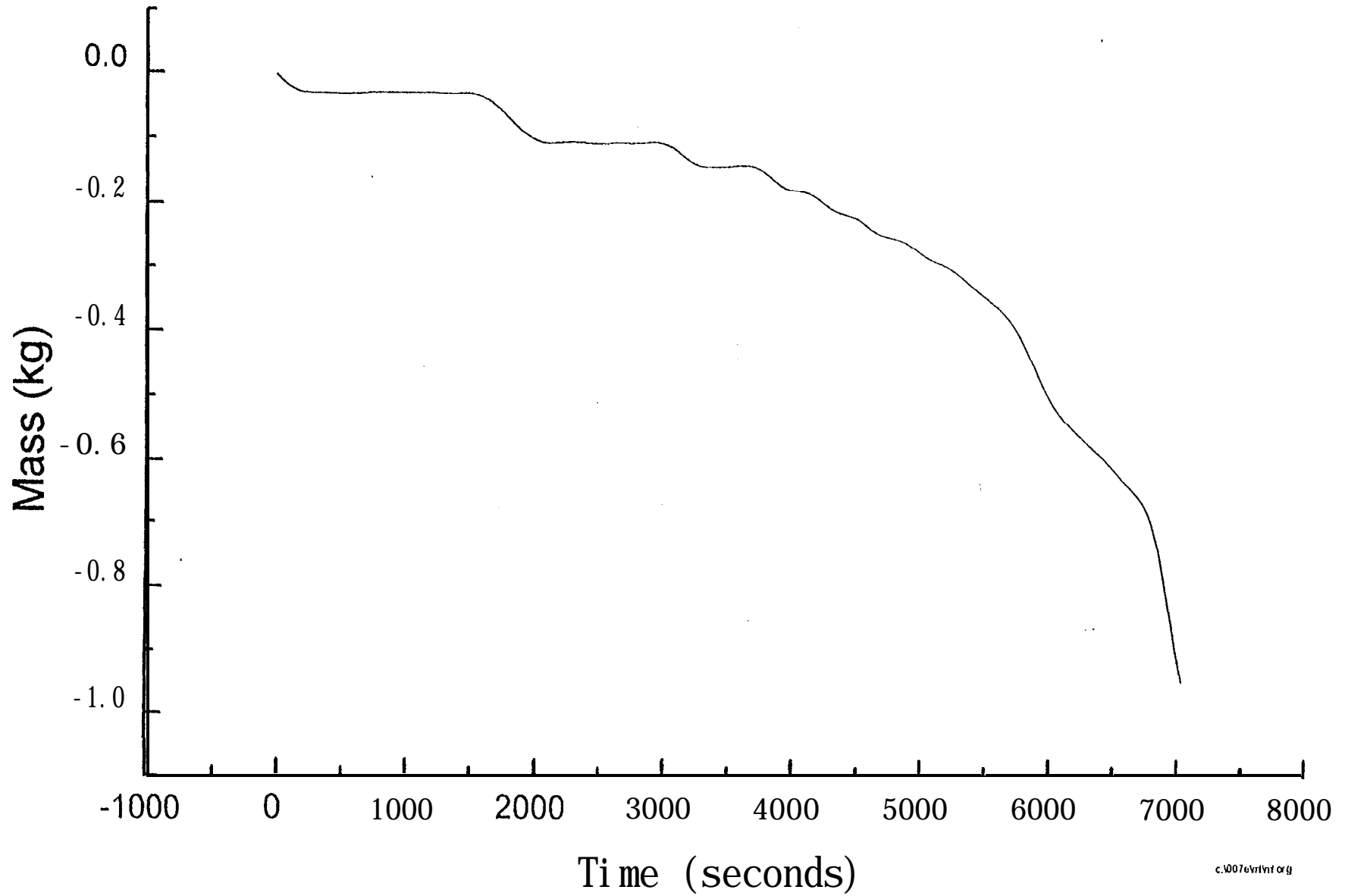

Fig. 6.2.1-2
Mass loss (smouldering) - Test SM2

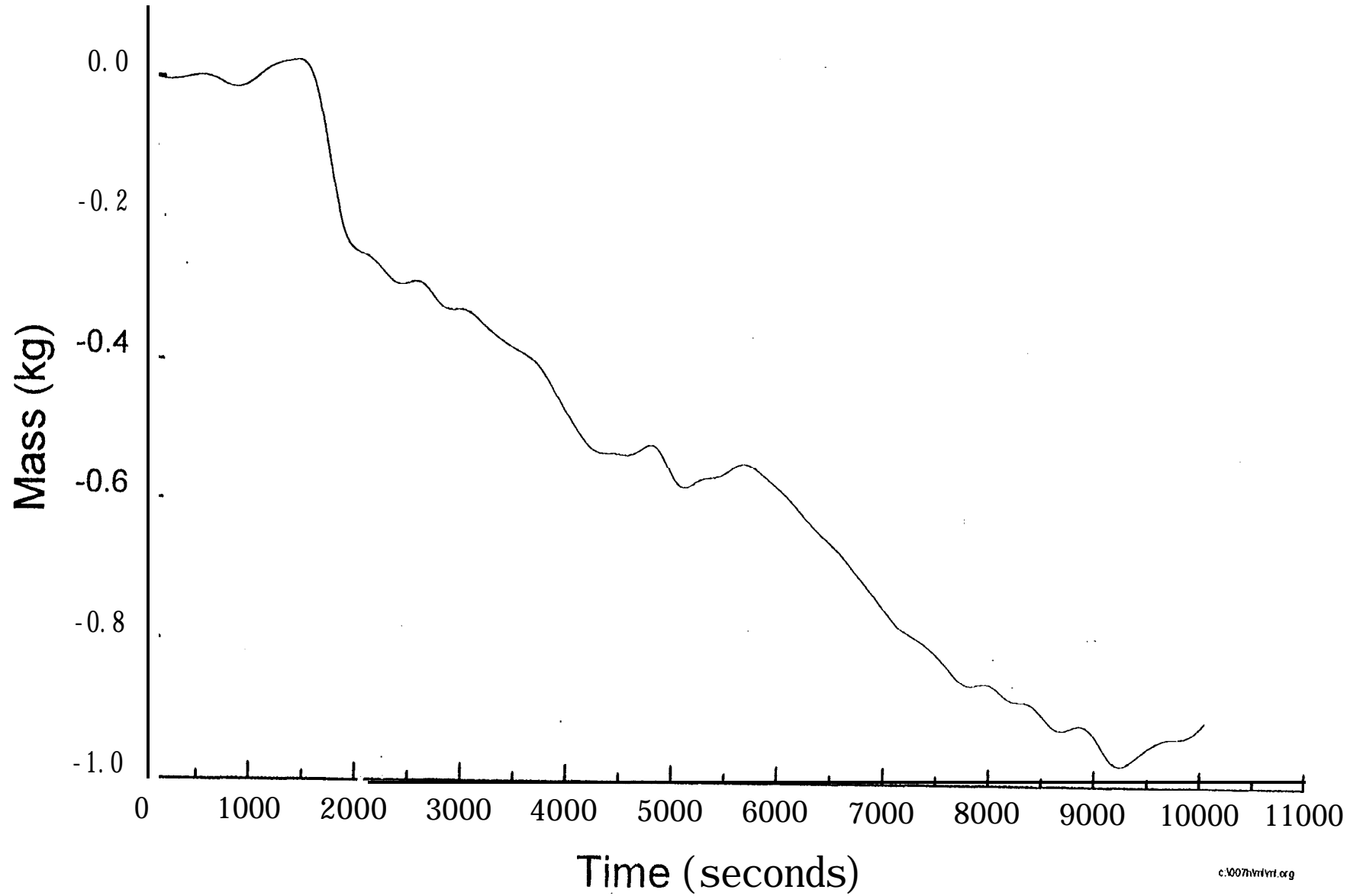

Fig. 6.2.1-3
Mass loss (smouldering) - Test SM3

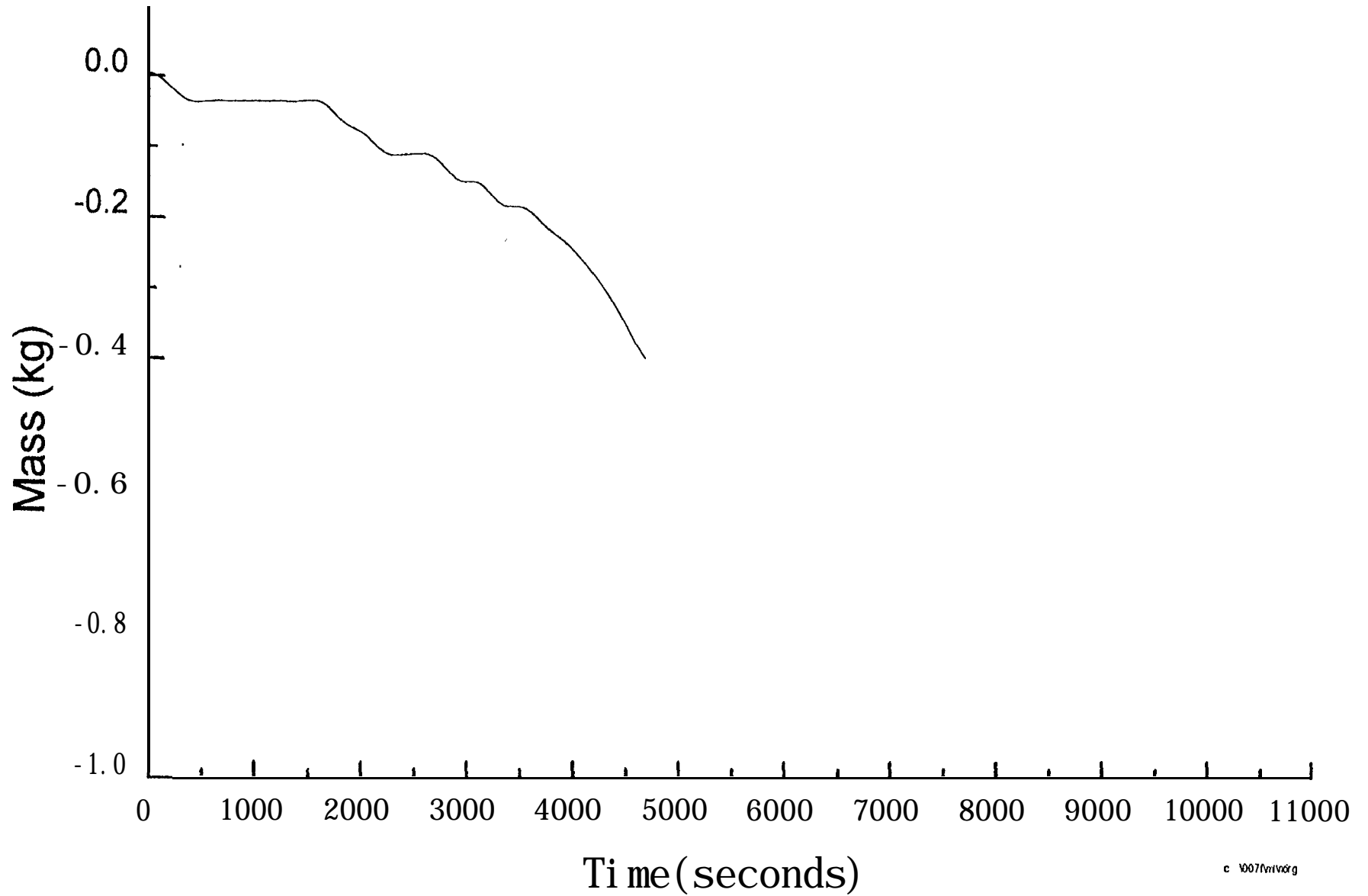

Fig. 6.2.1-4
Mass loss (smouldering) - Test SM4

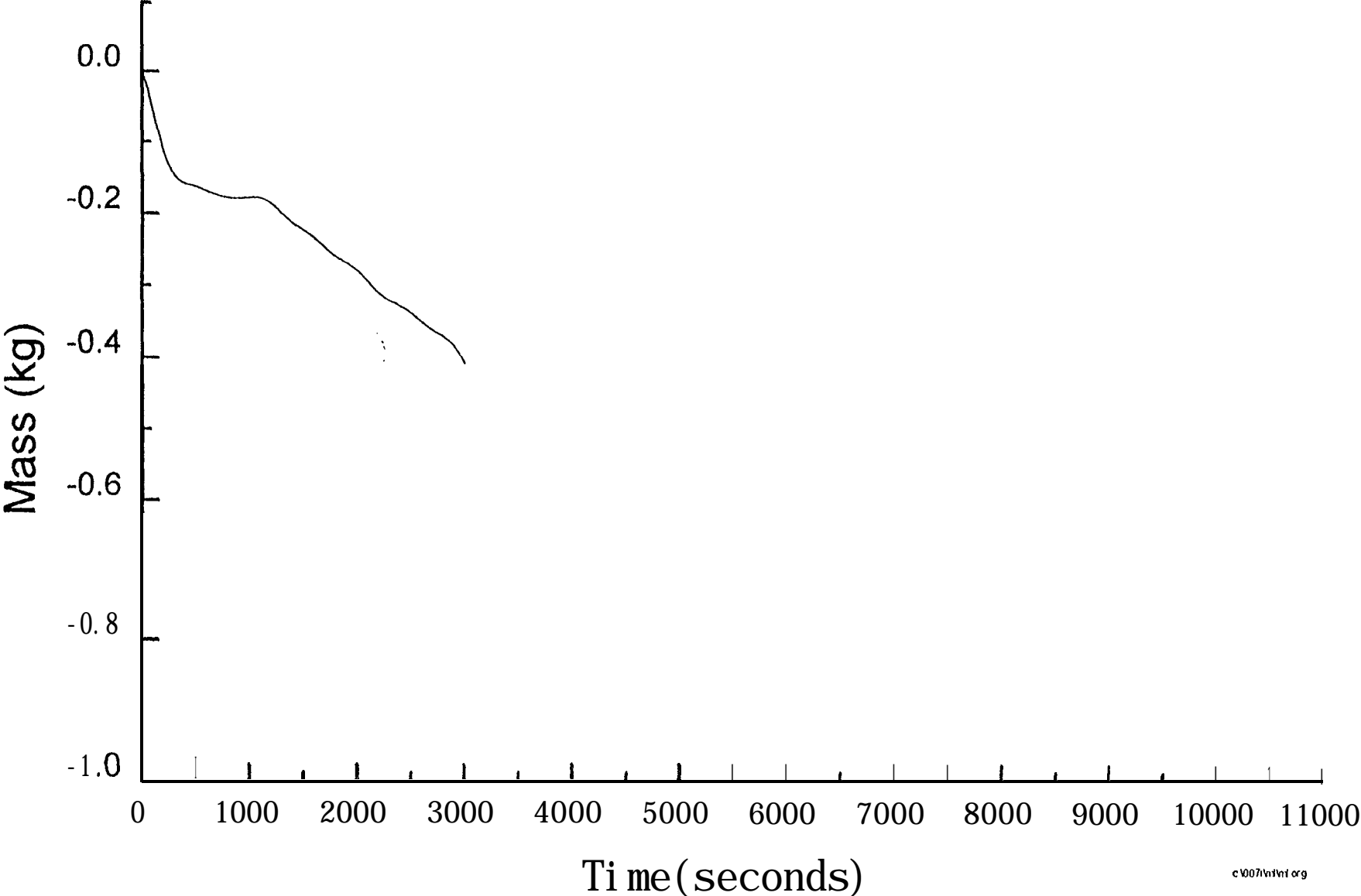

Fig. 6.2.1-5

Mass loss (smouldering) - Test SM5

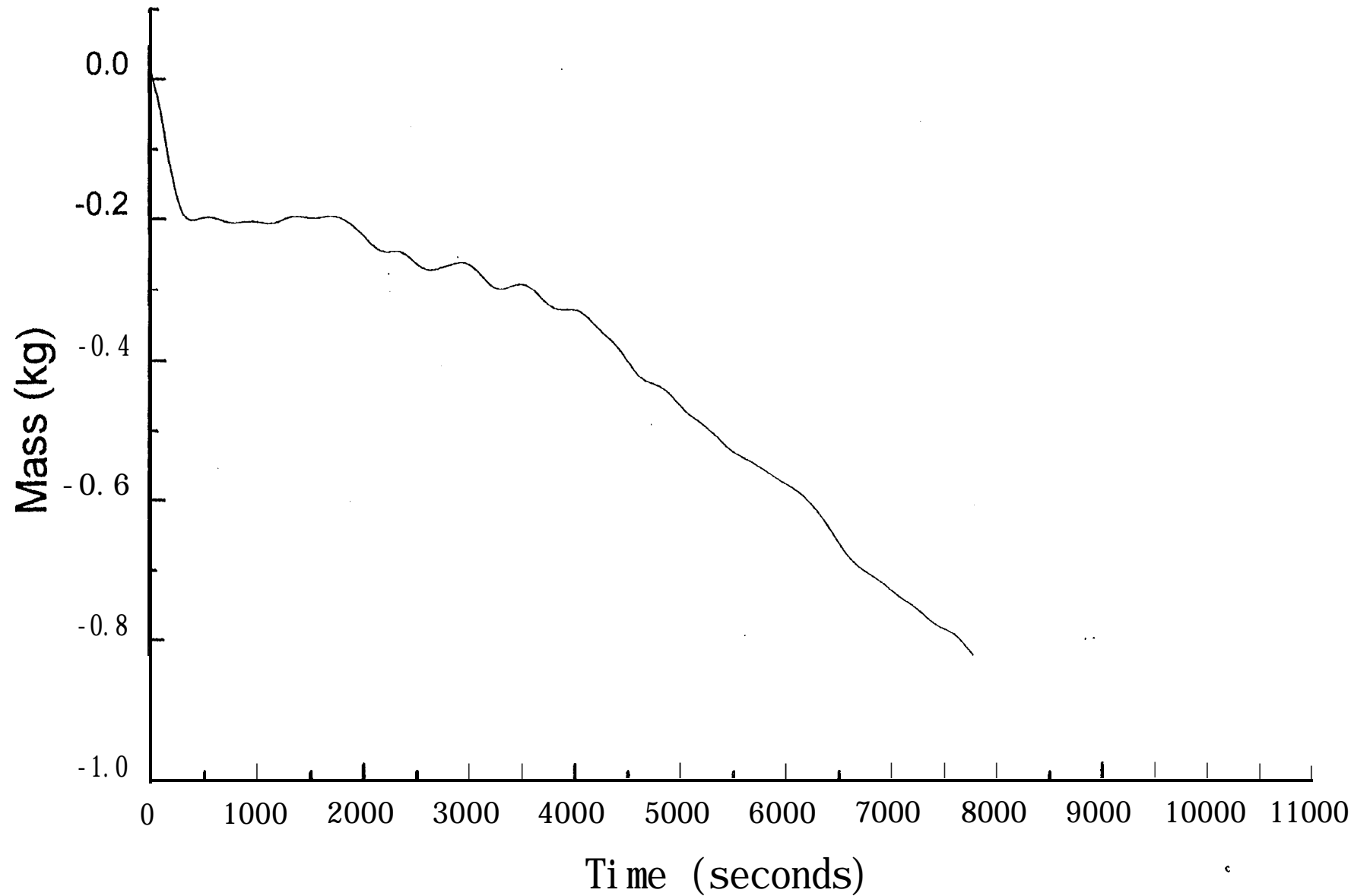

Fig. 6.2.1-6
Mass loss (smouldering) - Test SM6

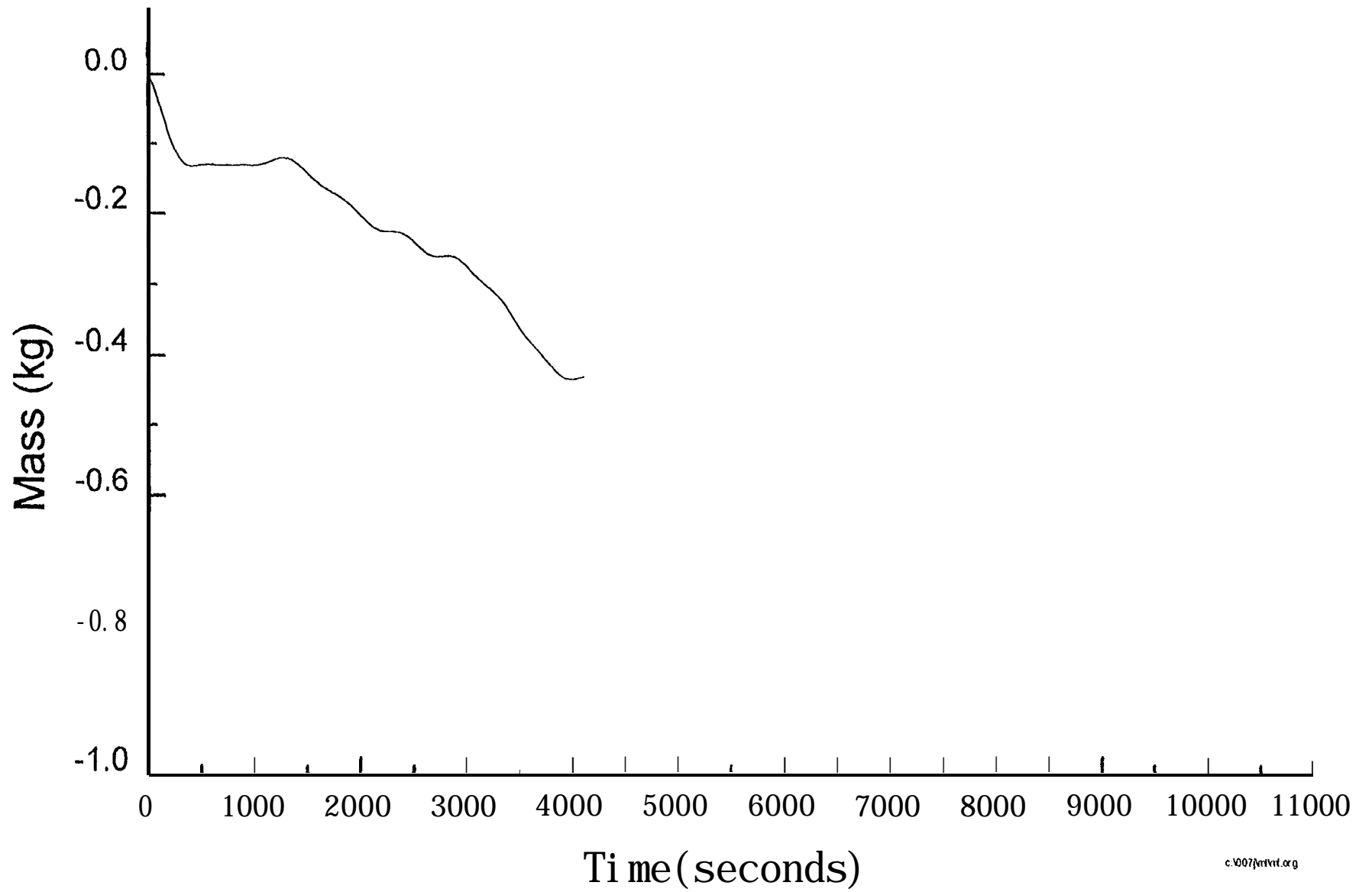

Fig. 6.2.1-7
Mass loss (smouldering) - Test SM7

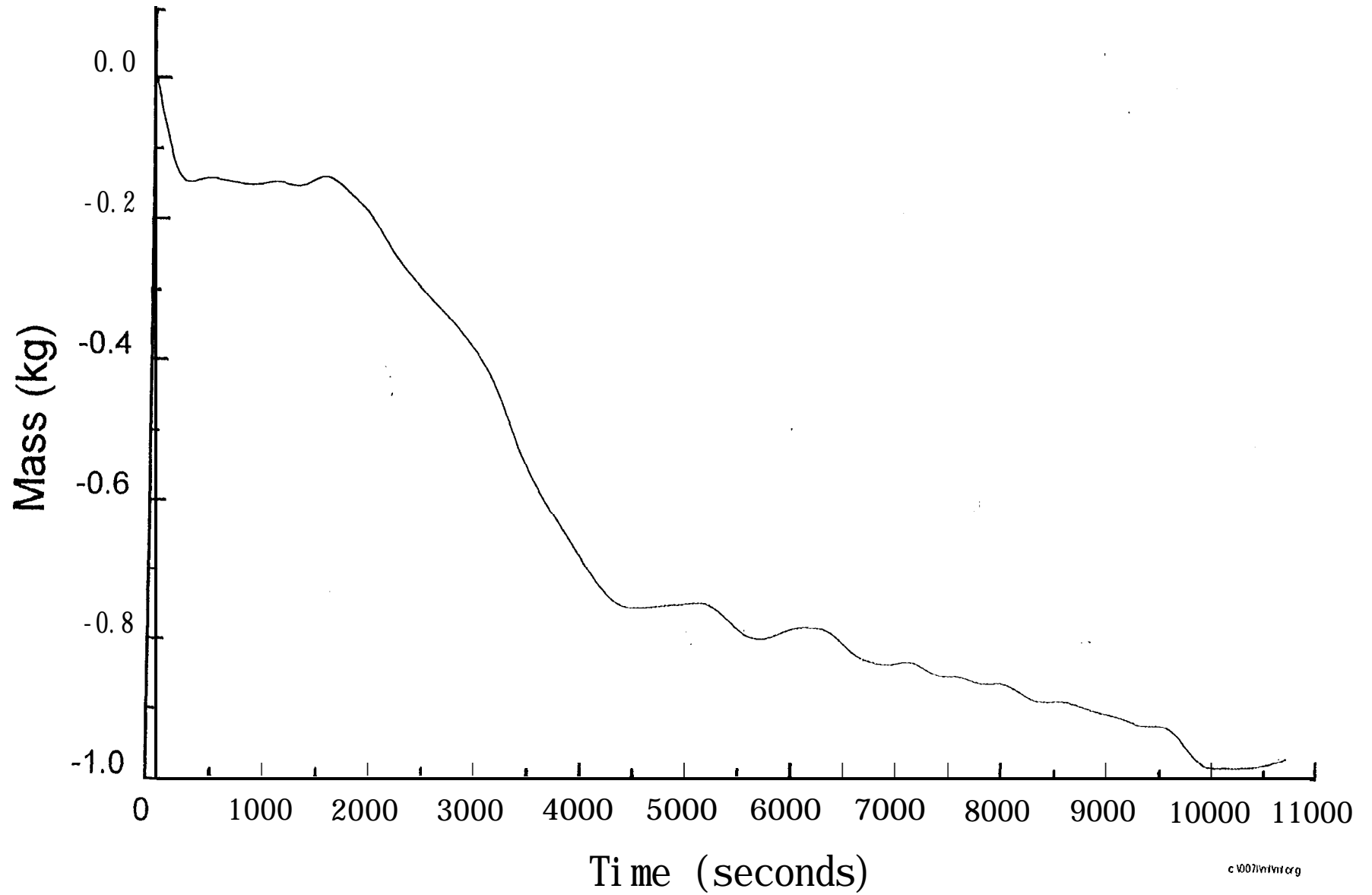

Fig. 6.2.4-8
Mass loss (smouldering) - Test SM8

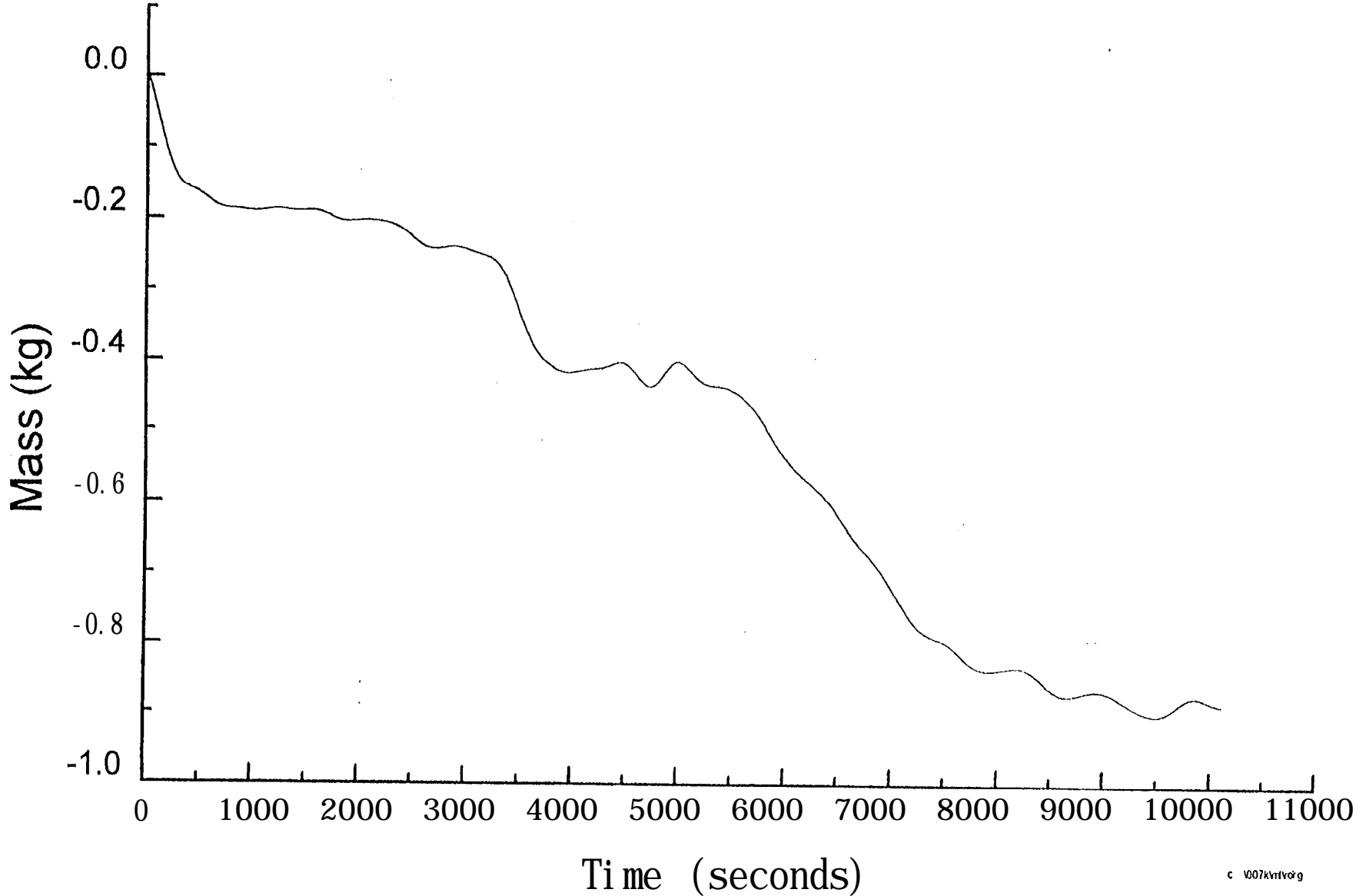

Fig. 6.2.2-I

Average temperature in room 102 (Smouldering) - Test SM1

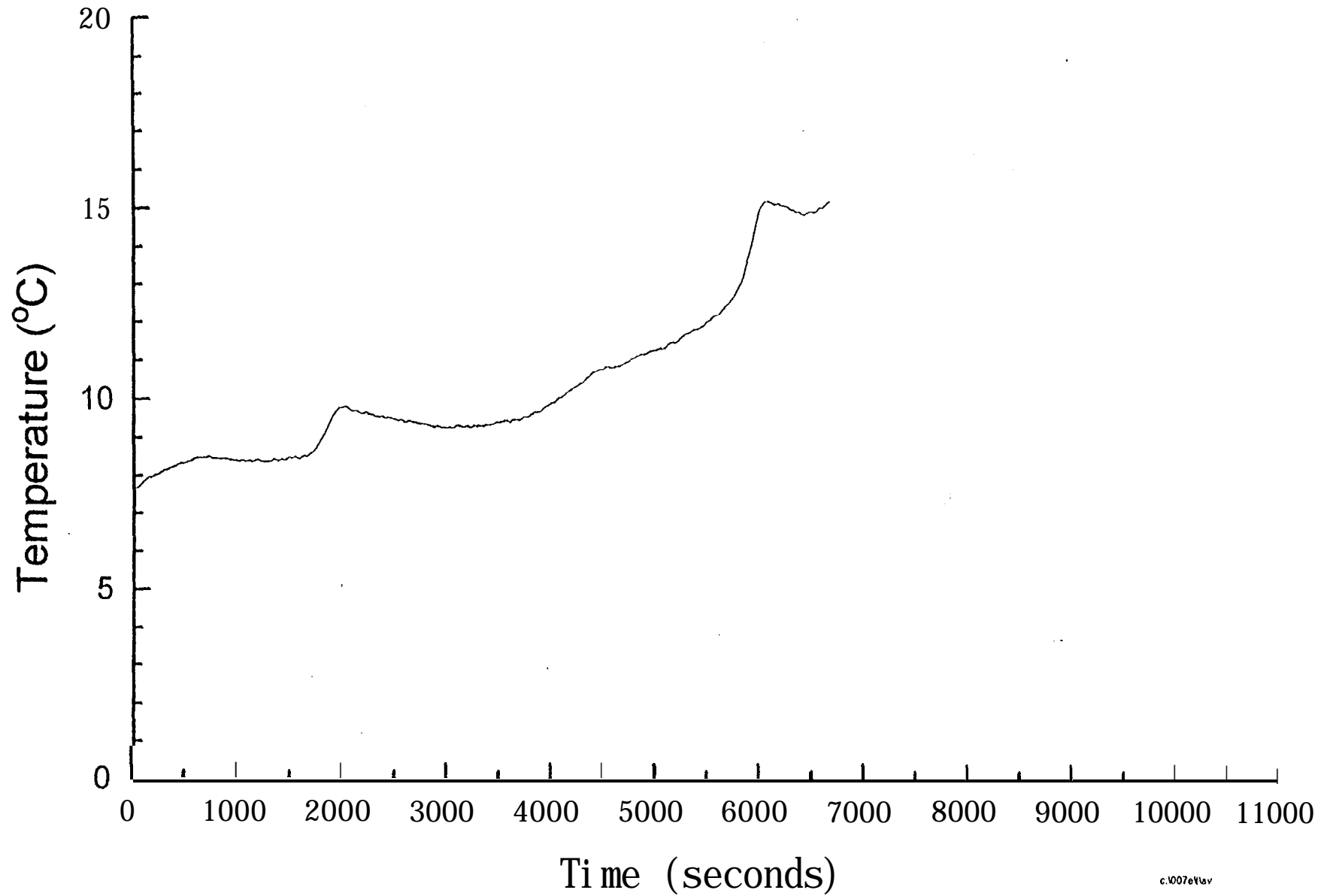

Fig. 6.2.2-2
Average temperature in room 102 (Smouldering) - Test SM2

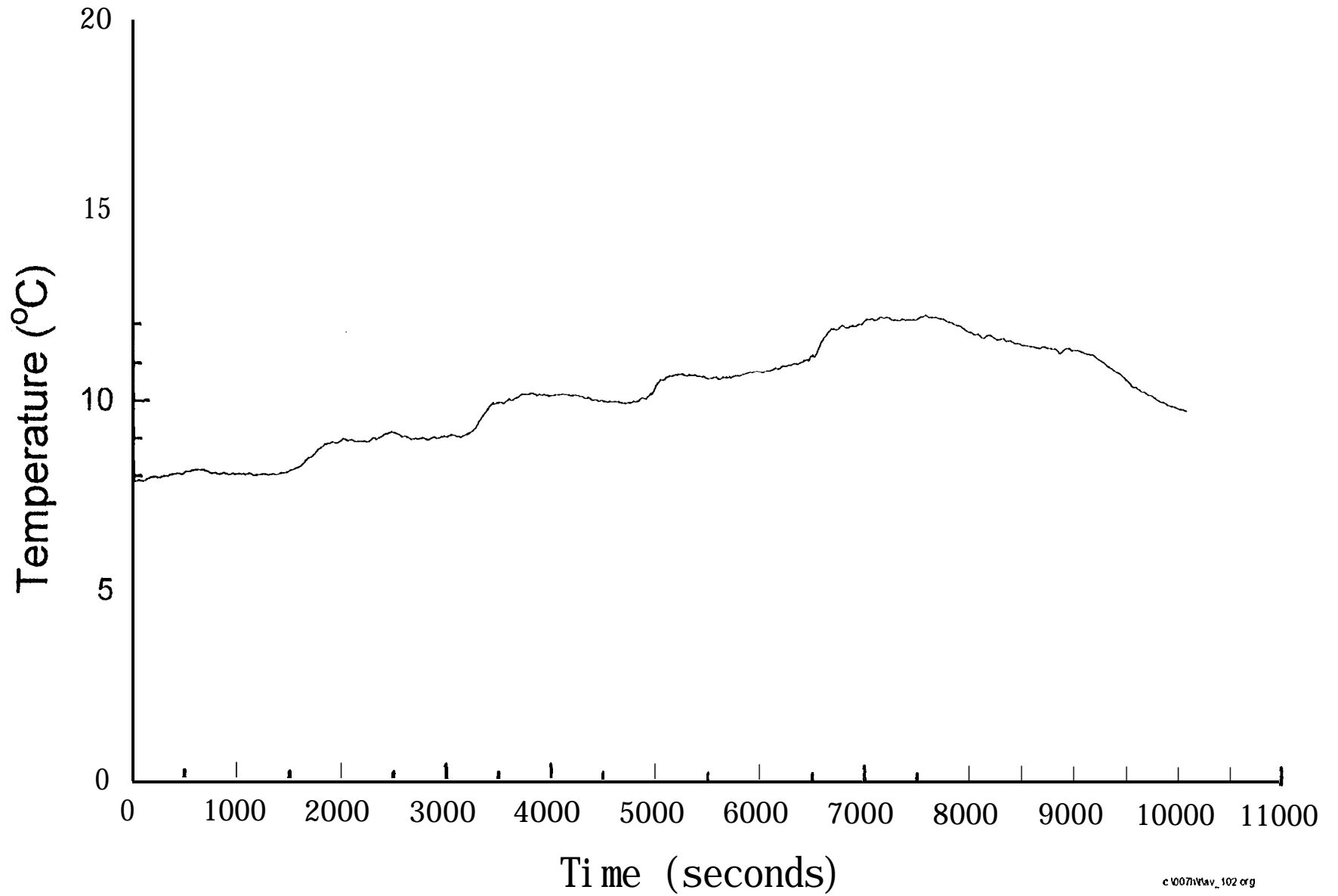

Fig. 6.2.2-3
Average temperature in room 102 (Smouldering) - Test SM3

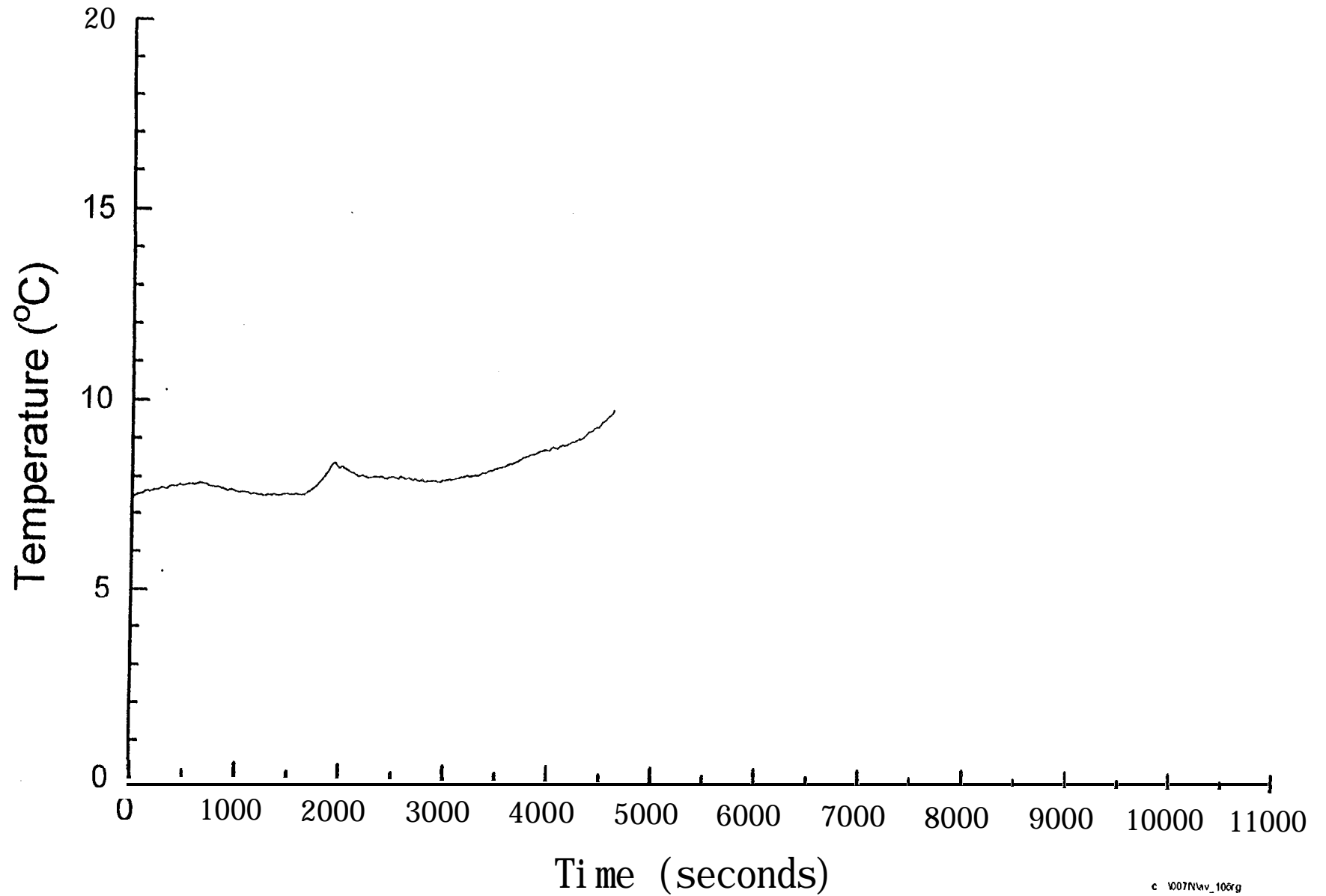

Fig. 6.2.2-4
Average temperature in room 102 (Smouldering) - Test SM4

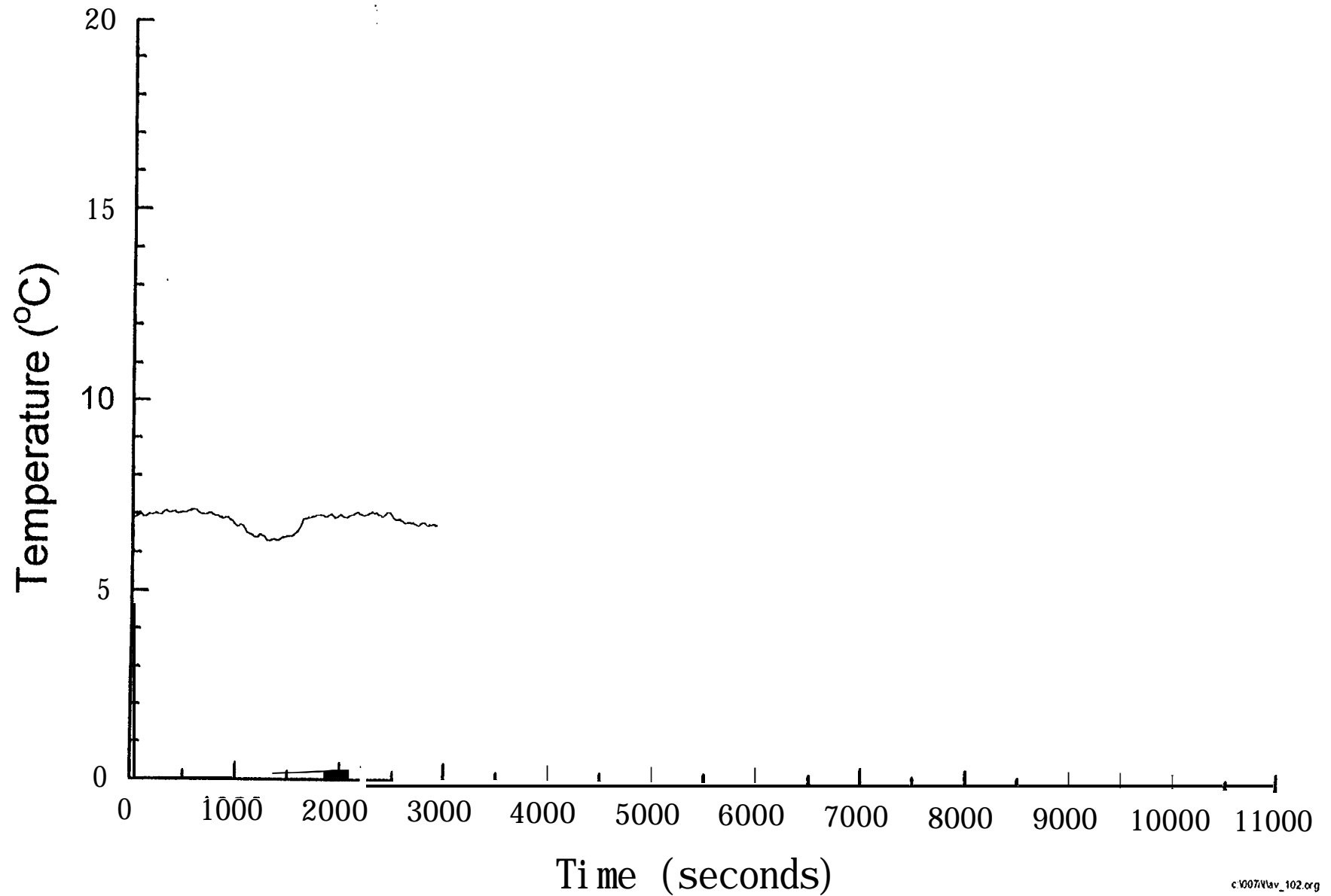

Fig. 6.2.2-5
Average temperature in room 102 (Smouldering) - Test SM5

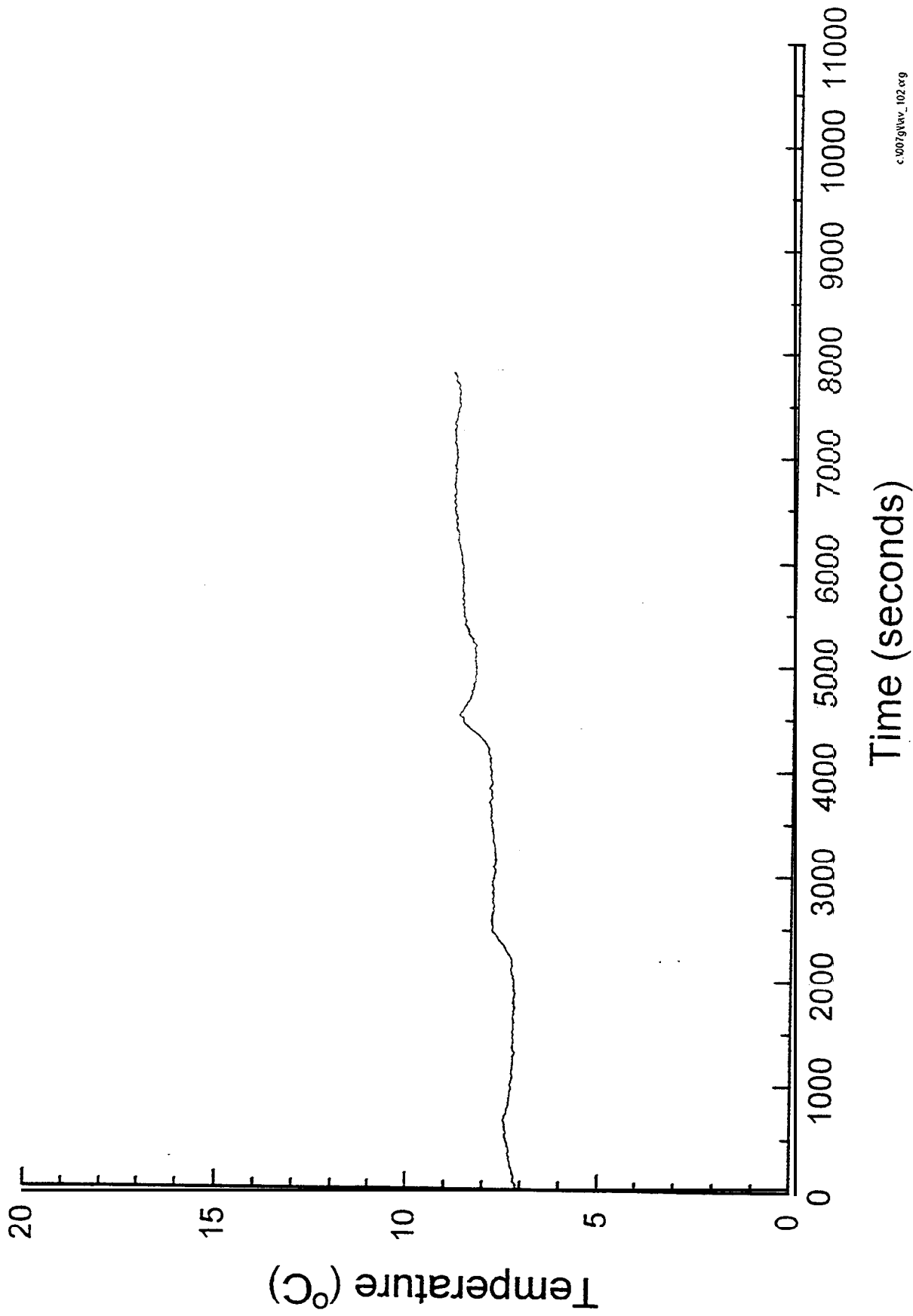

Fig. 6.2.2-6
Average temperature in room 102 (Smouldering) - Test SM6

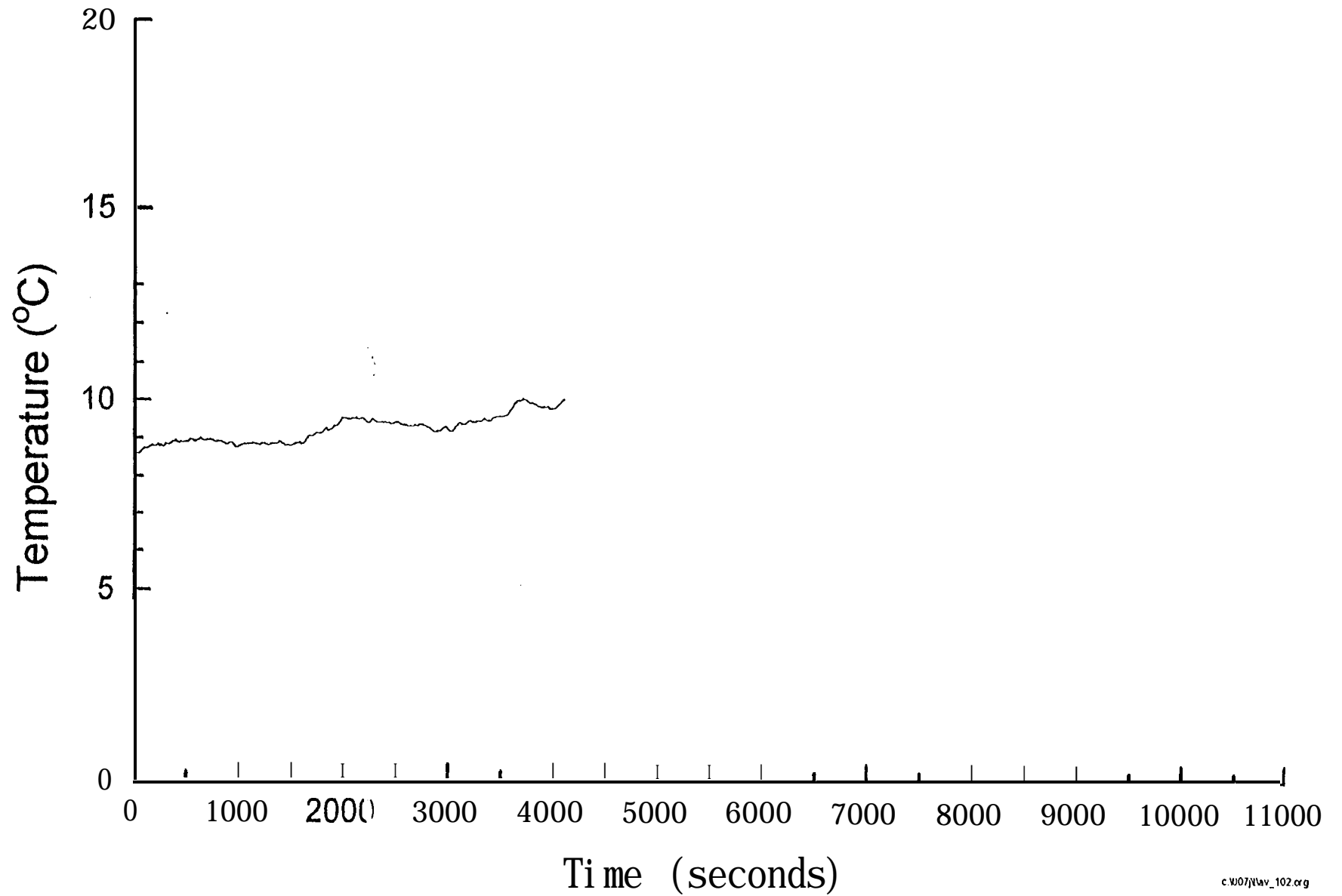

Fig. 6.2.2-7
Average temperature in room 102 (Smouldering) - Test SM7

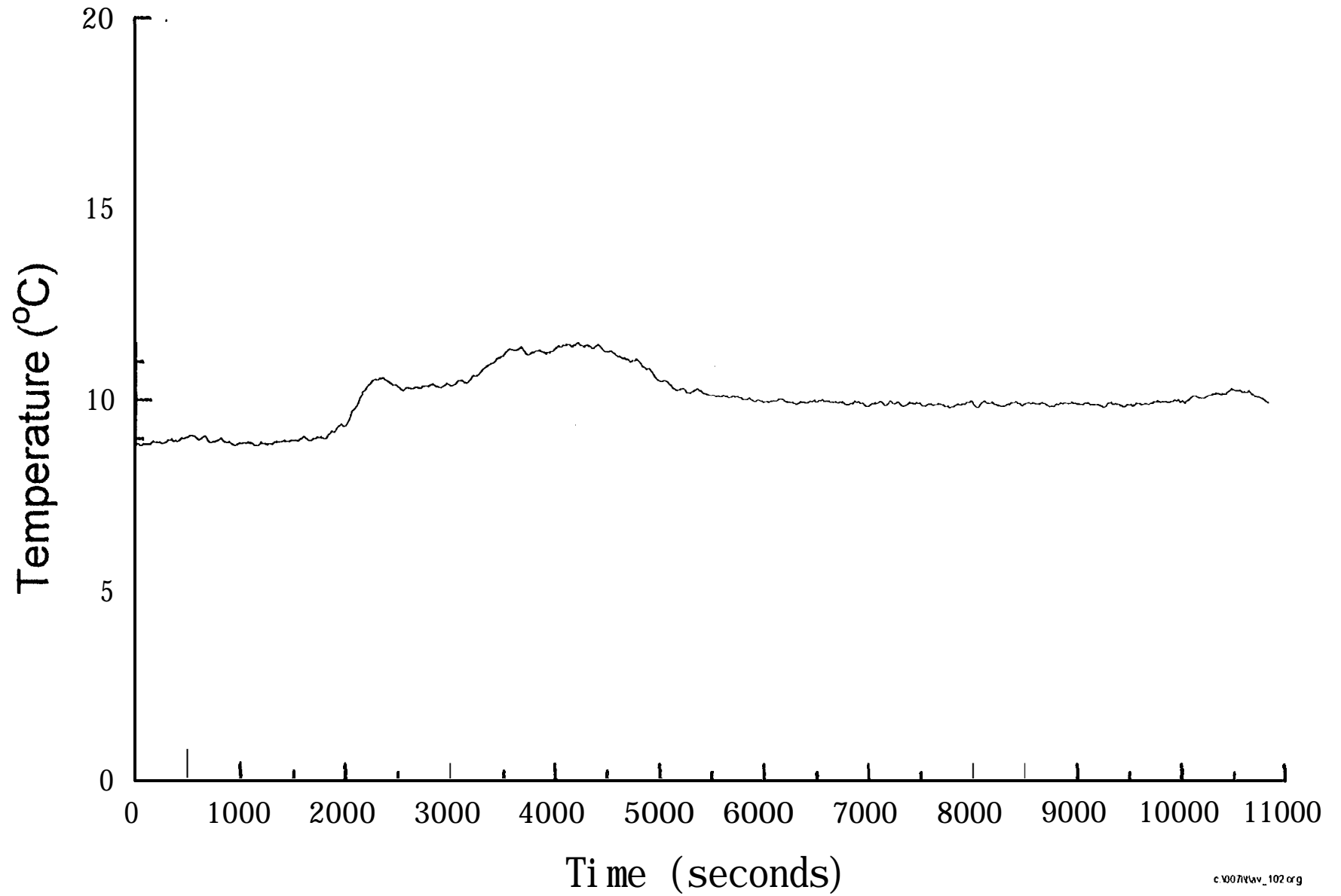

Fig 6.2.2-8

Average temperature in room 102 (Smouldering) - Test SM8

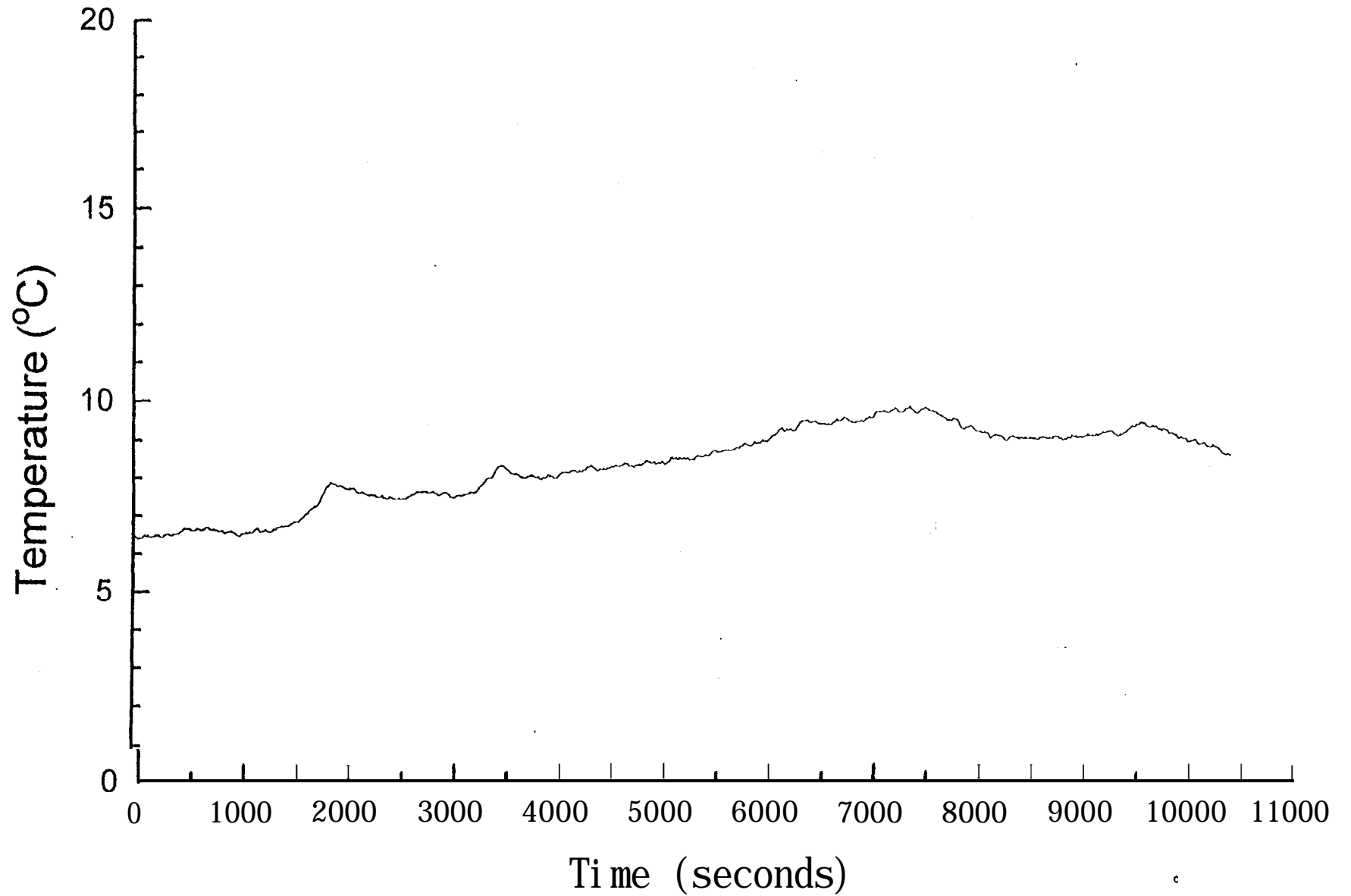

Fig. 6.2.2-9

Average temperature in room 101 (Smouldering) - Test SM1

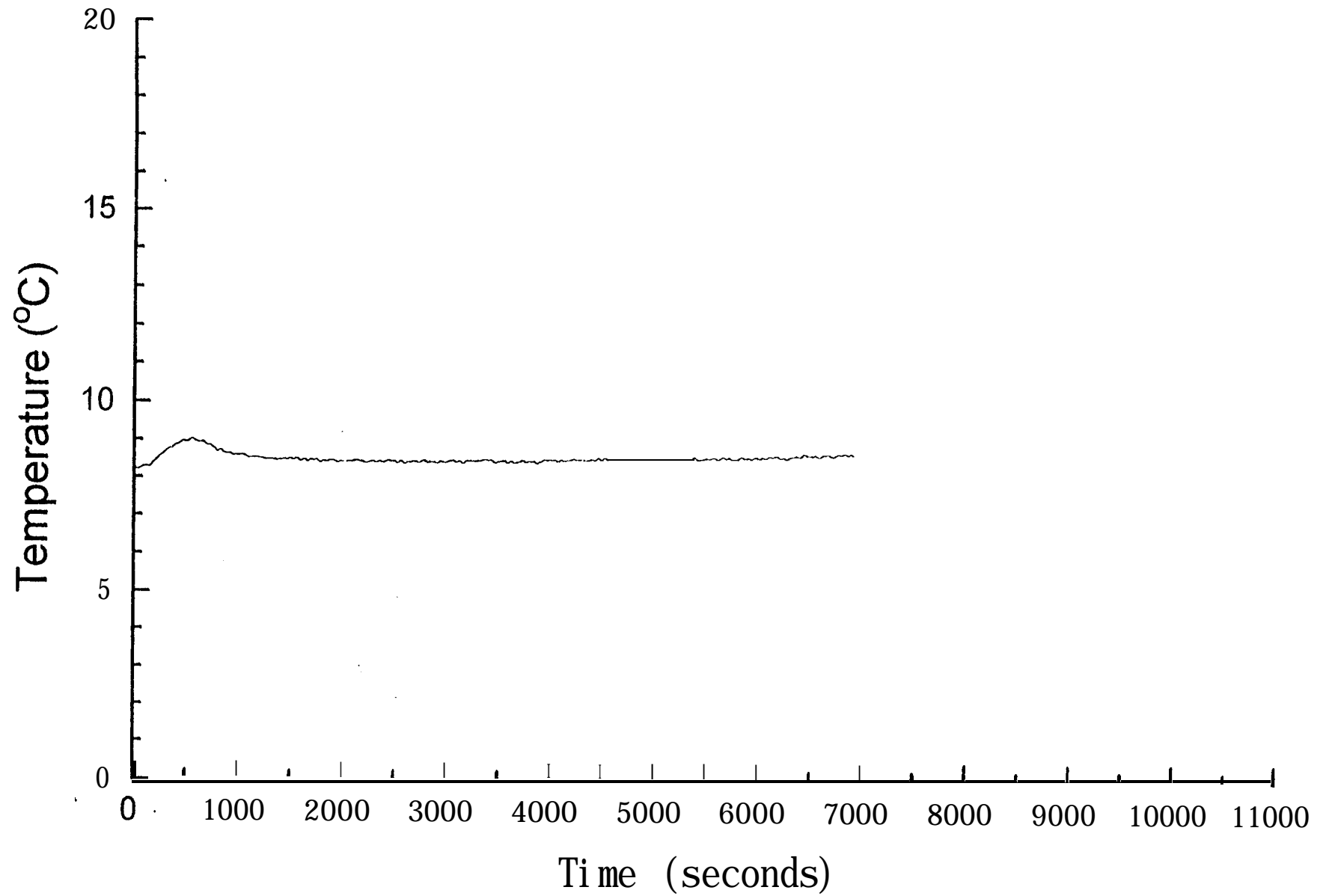

Fig. 6.2.2-I 0
Average temperature in room 101 (Smouldering) - Test SM2

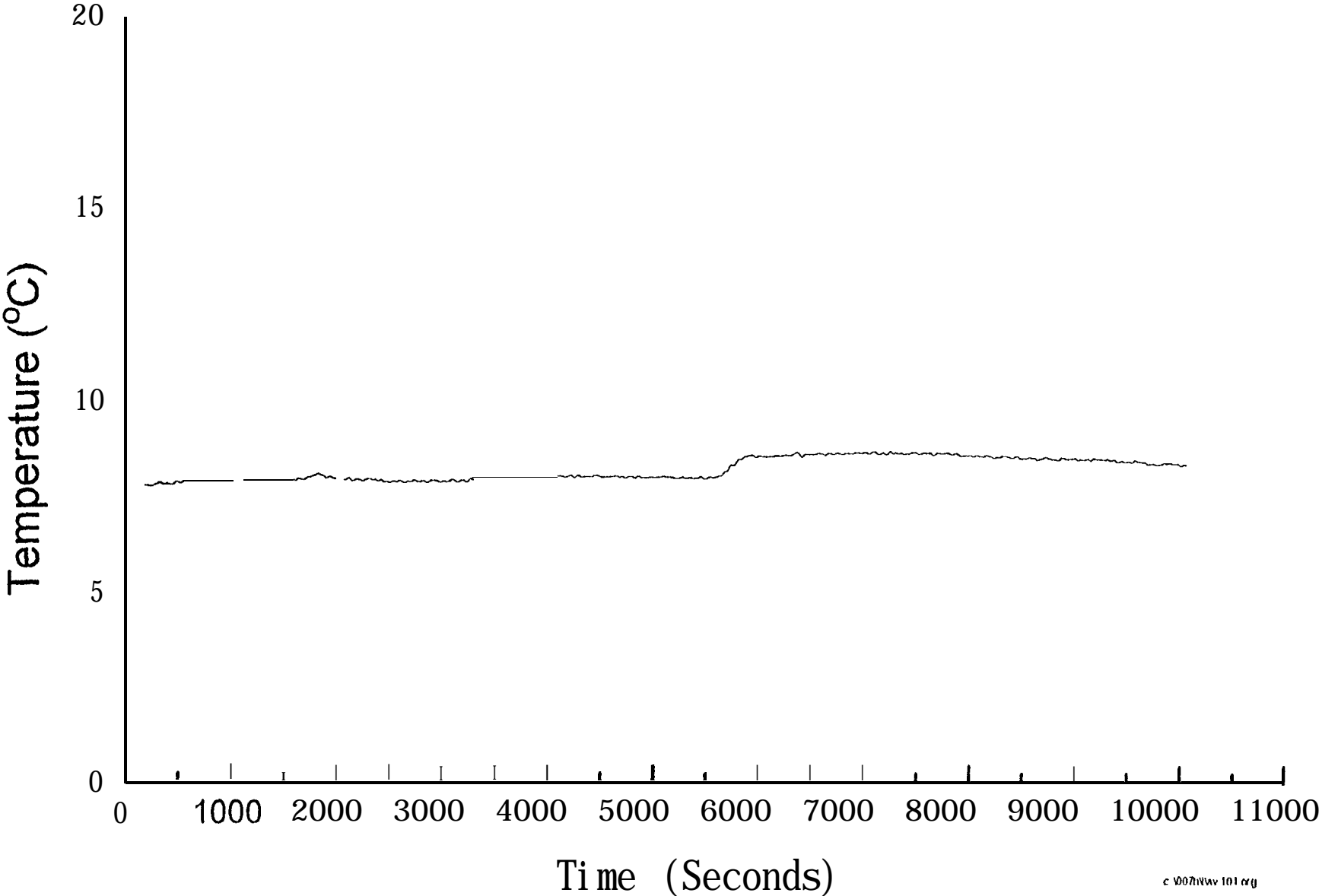

Fig. 6.2.2-I 1

Average temperature in room 101 (Smouldering) - Test SM3

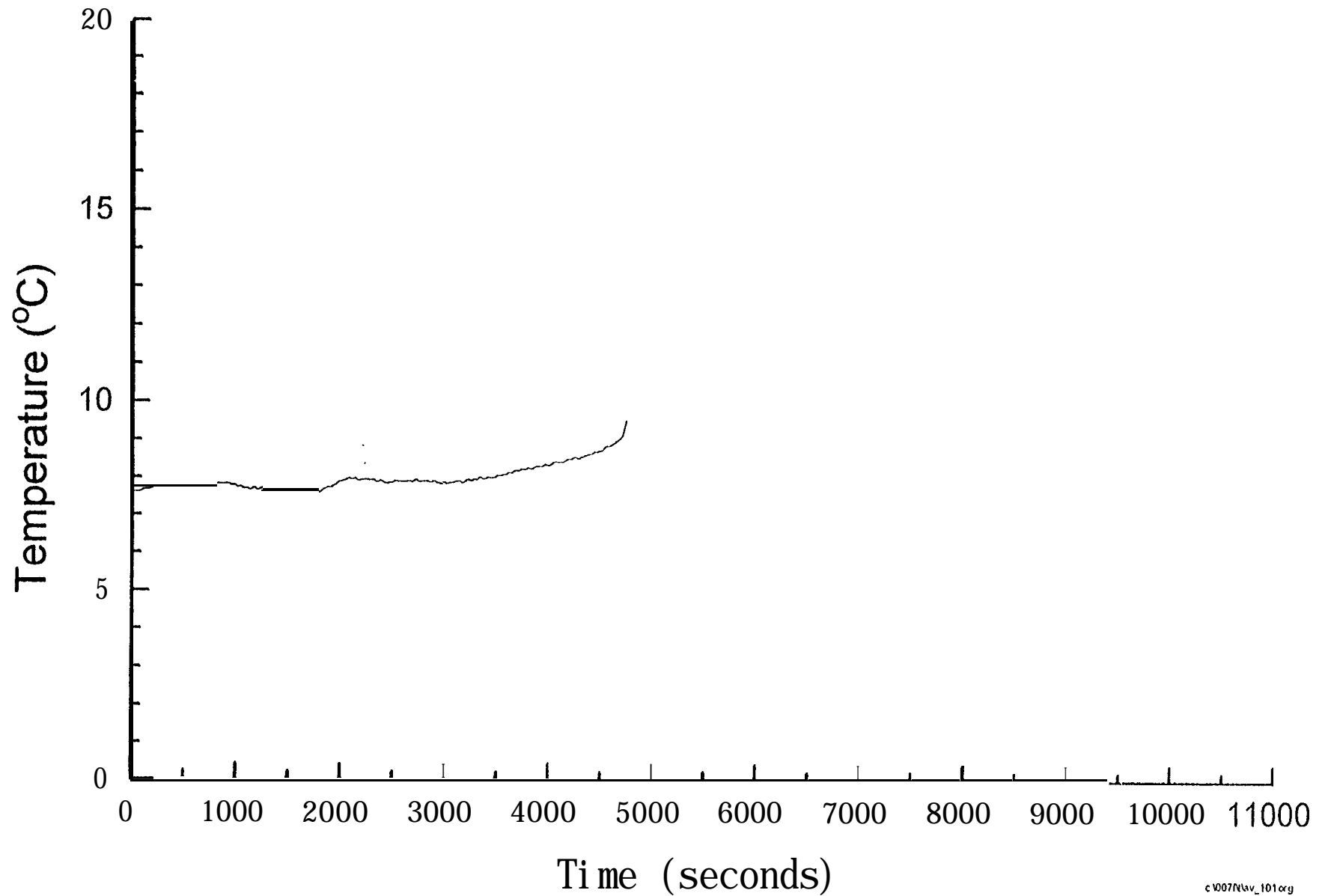

Fig. 6.2.2-I 2
Average temperature in room 101 (Smouldering) - Test SM4

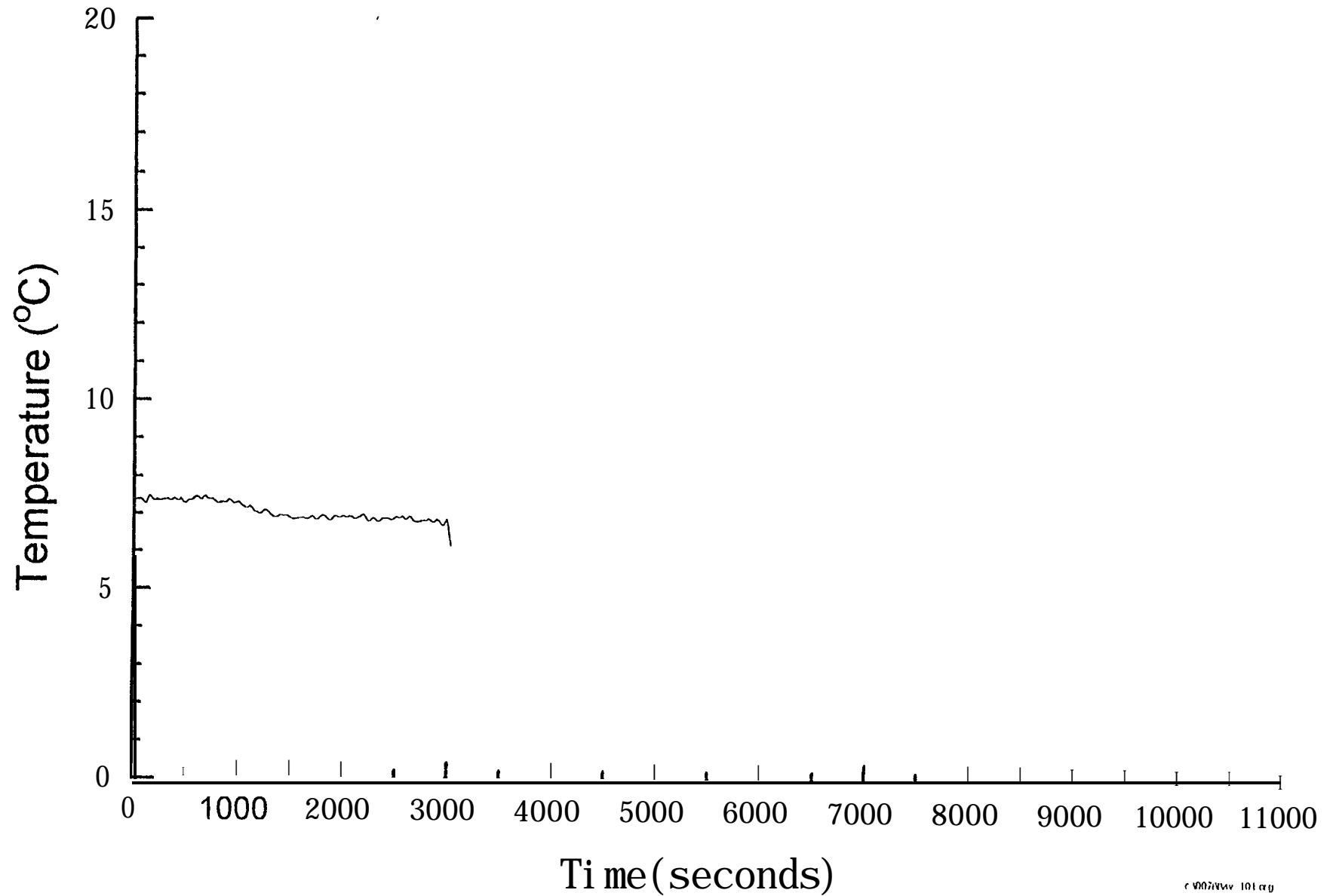

Fig. 6.2.2-I 3

Average temperature in room 101 (Smouldering) - Test SM5

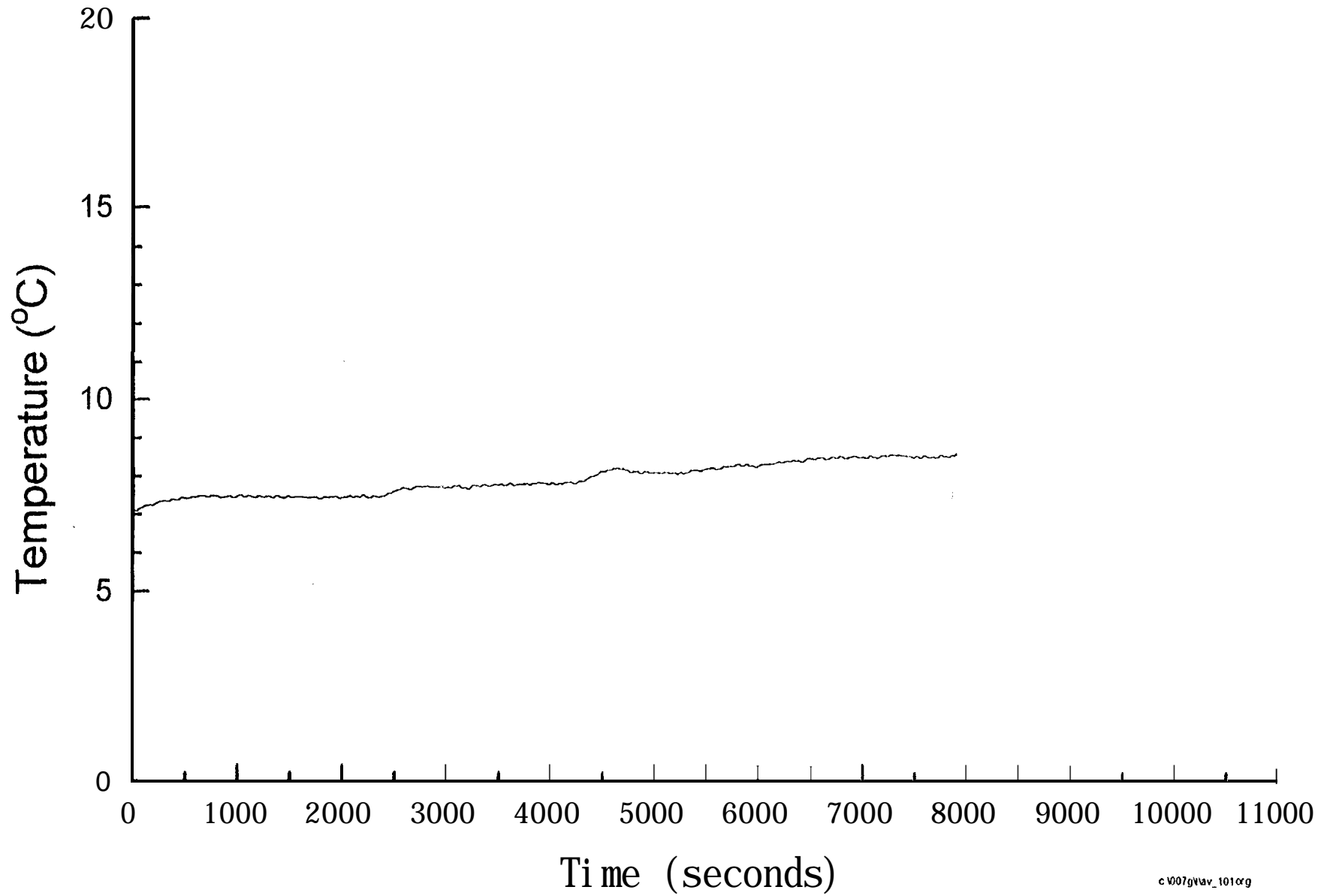

Fig. 6.2.2-14

Average temperature in room 101 (Smouldering) - Test SM6

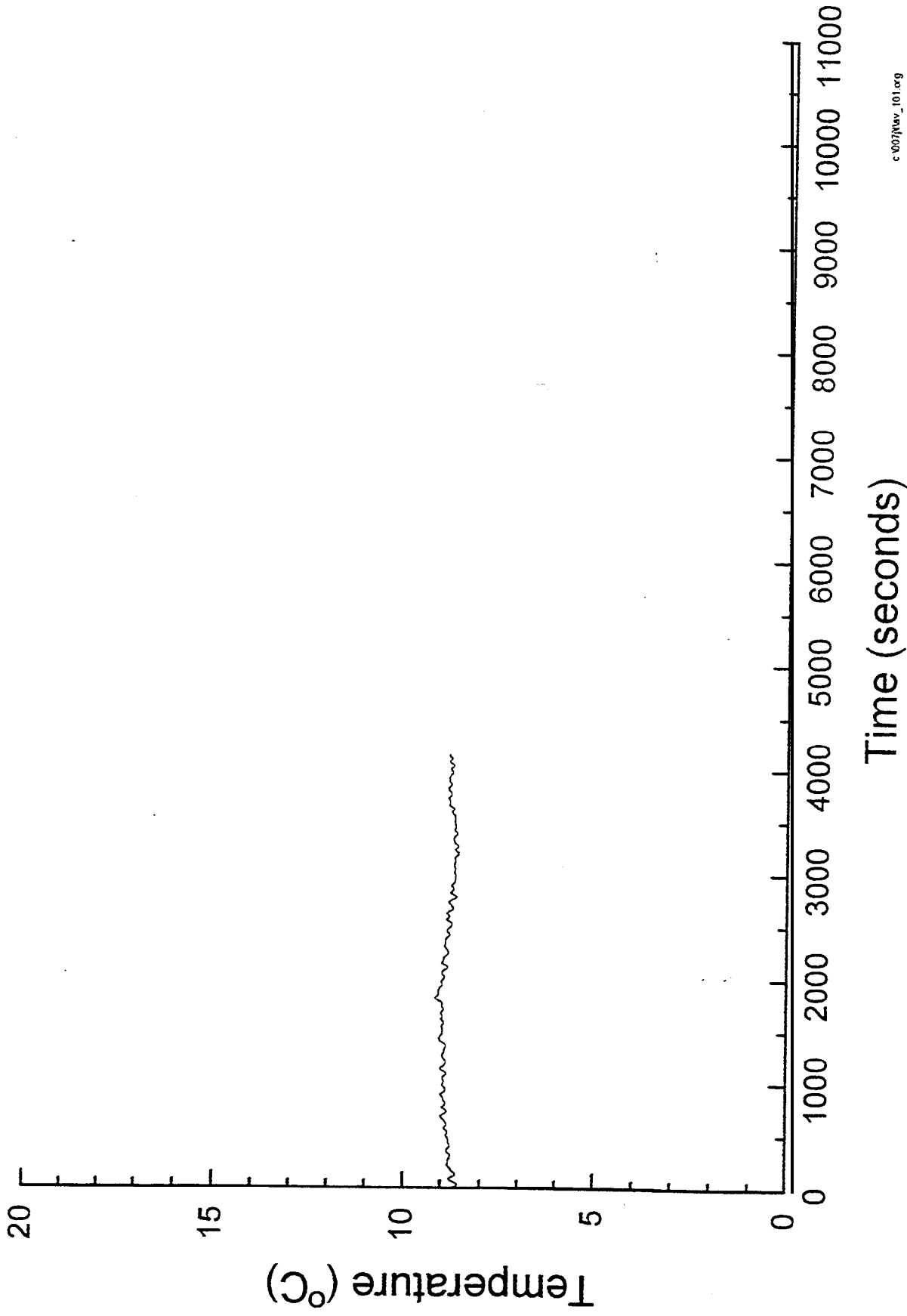

Fig. 6.2.2-I 5

Average temperature in room 101 (Smouldering) - Test SM7

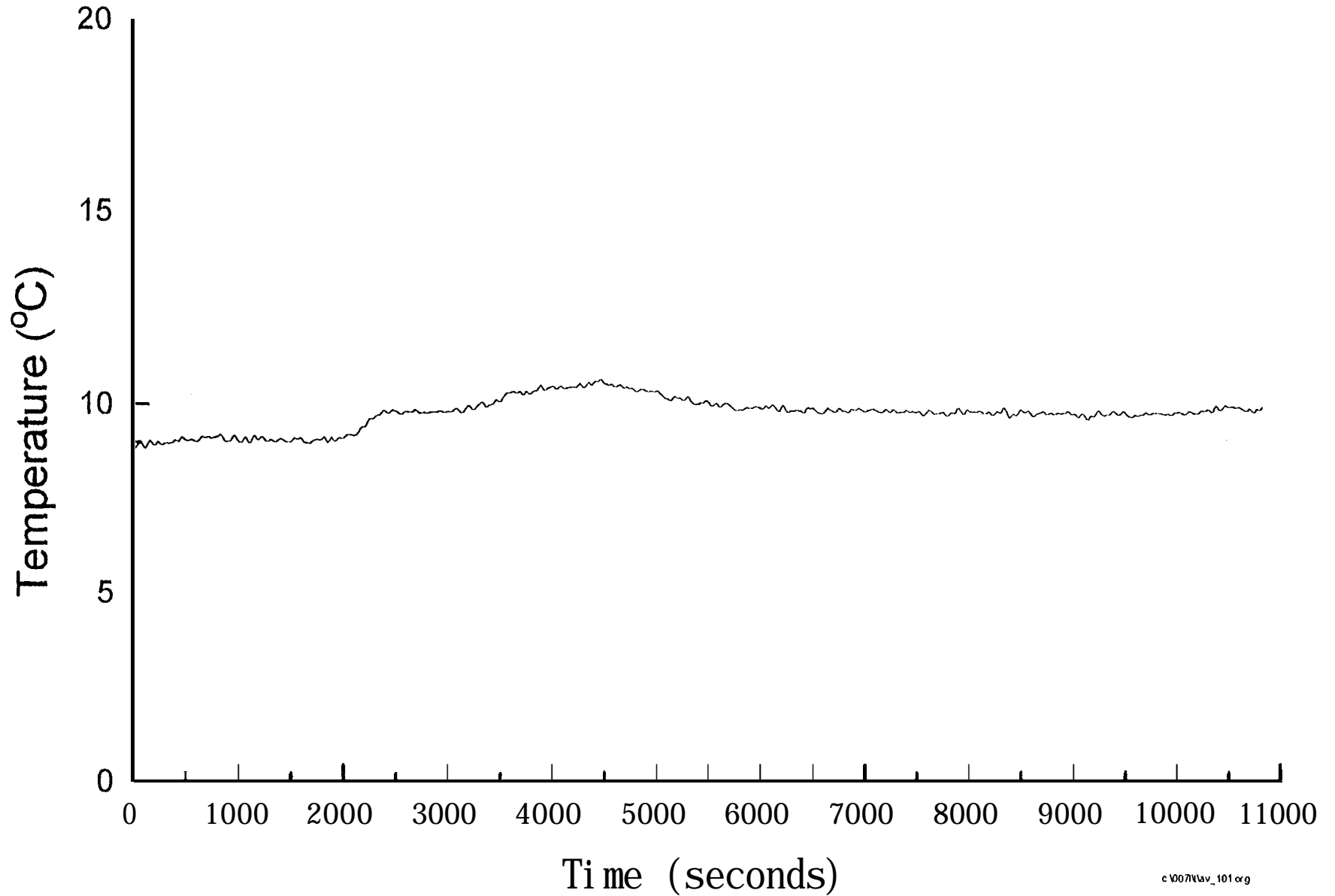

Fig. 6.2.2-I 6

Average temperature in room 101 (Smouldering) - Test SM8

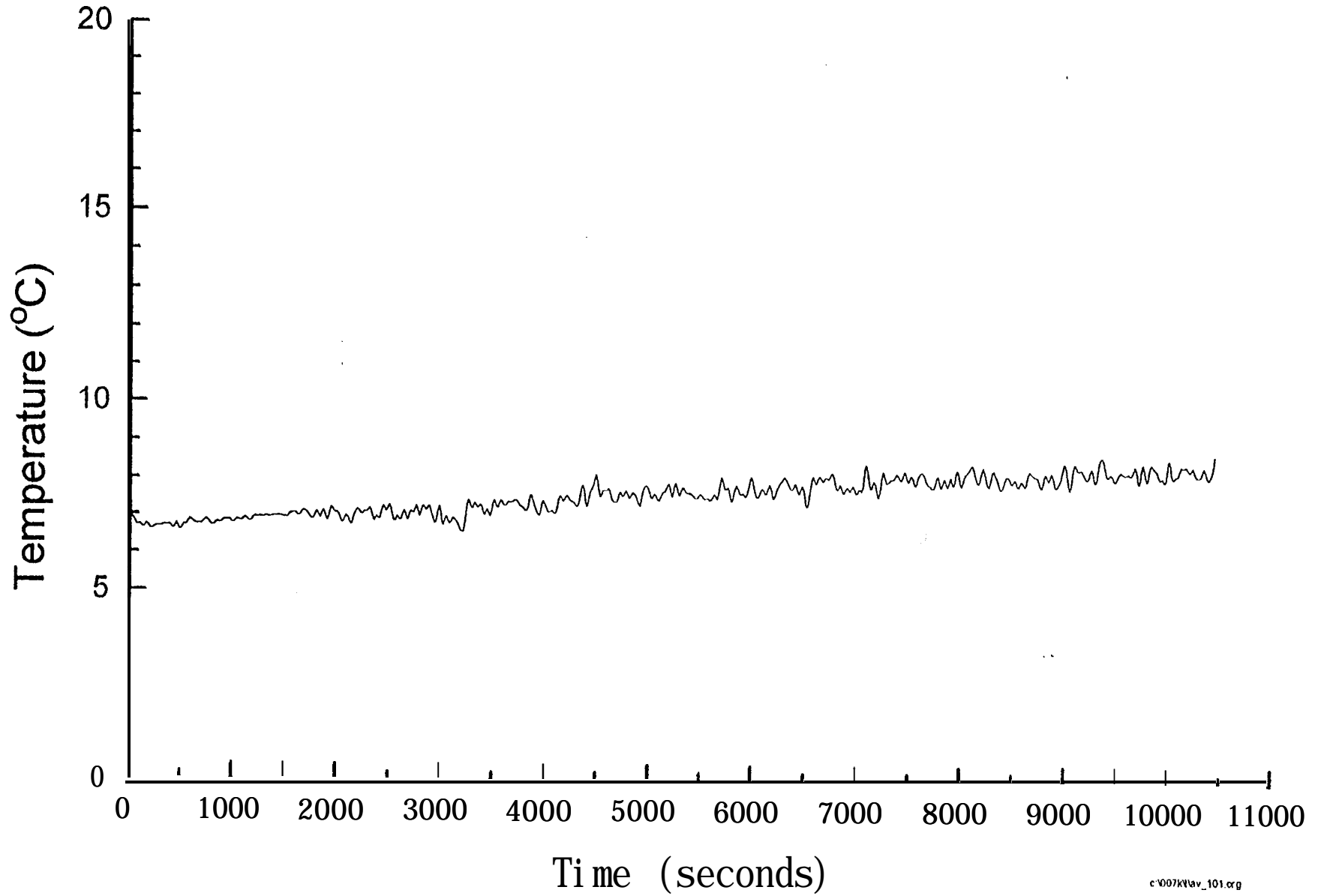

Fig. 6.2.2-I 7

Average temperature in corridor of level1 (Smouldering) - Test SM1

1.70m above floor

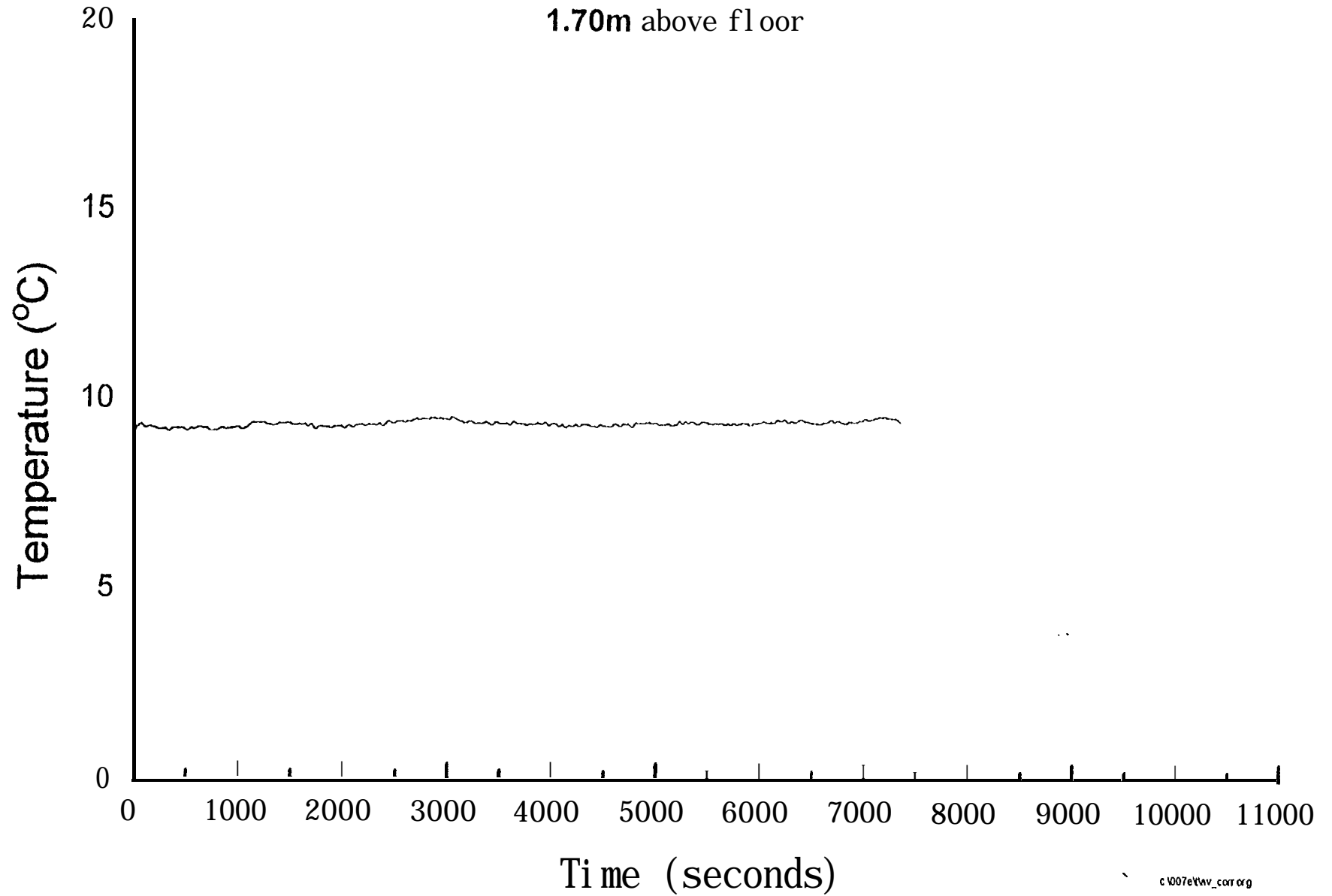

Fig. 6.2.2-I 8

Average temperature in corridor of level1 (Smouldering) - Test SM2

1.70m above floor

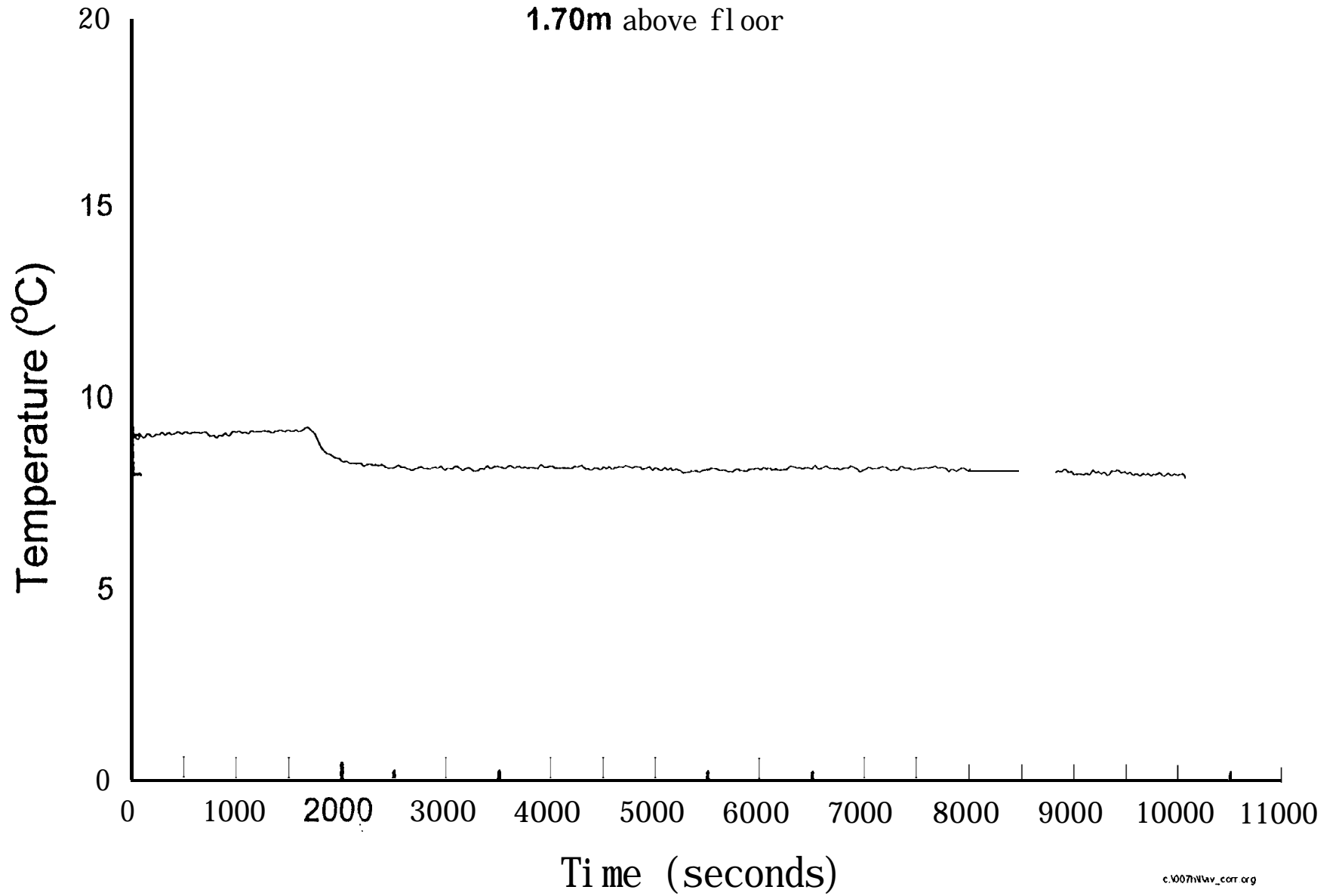

Fig. 6.2.2-I 9

Average temperature in corridor of level1 (Smouldering) - Test SM3

1.70m above floor

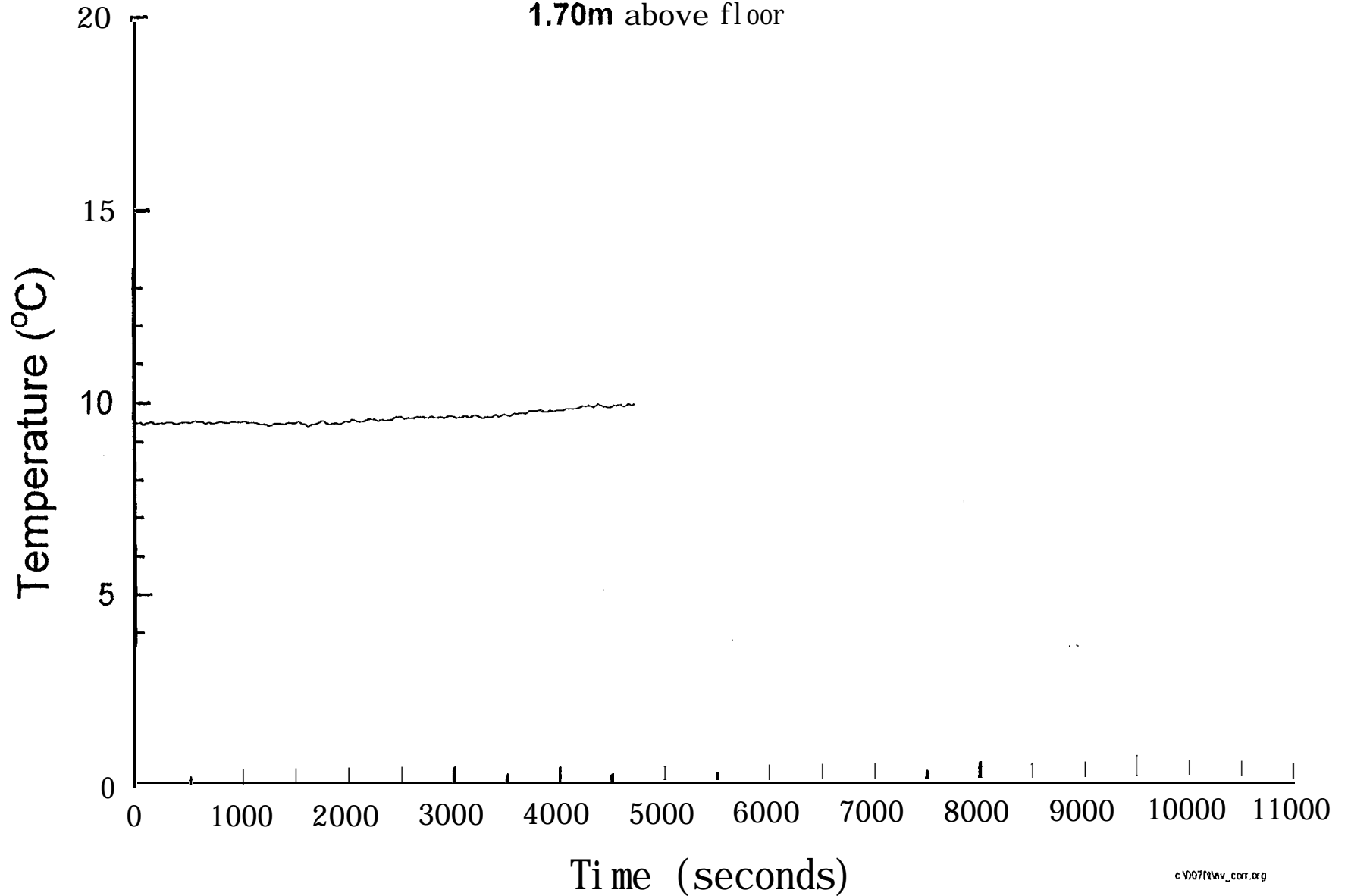

Fig. 6.2.2-20

Average temperature in corridor of level1 (Smouldering) - Test SM4

1.70m above floor

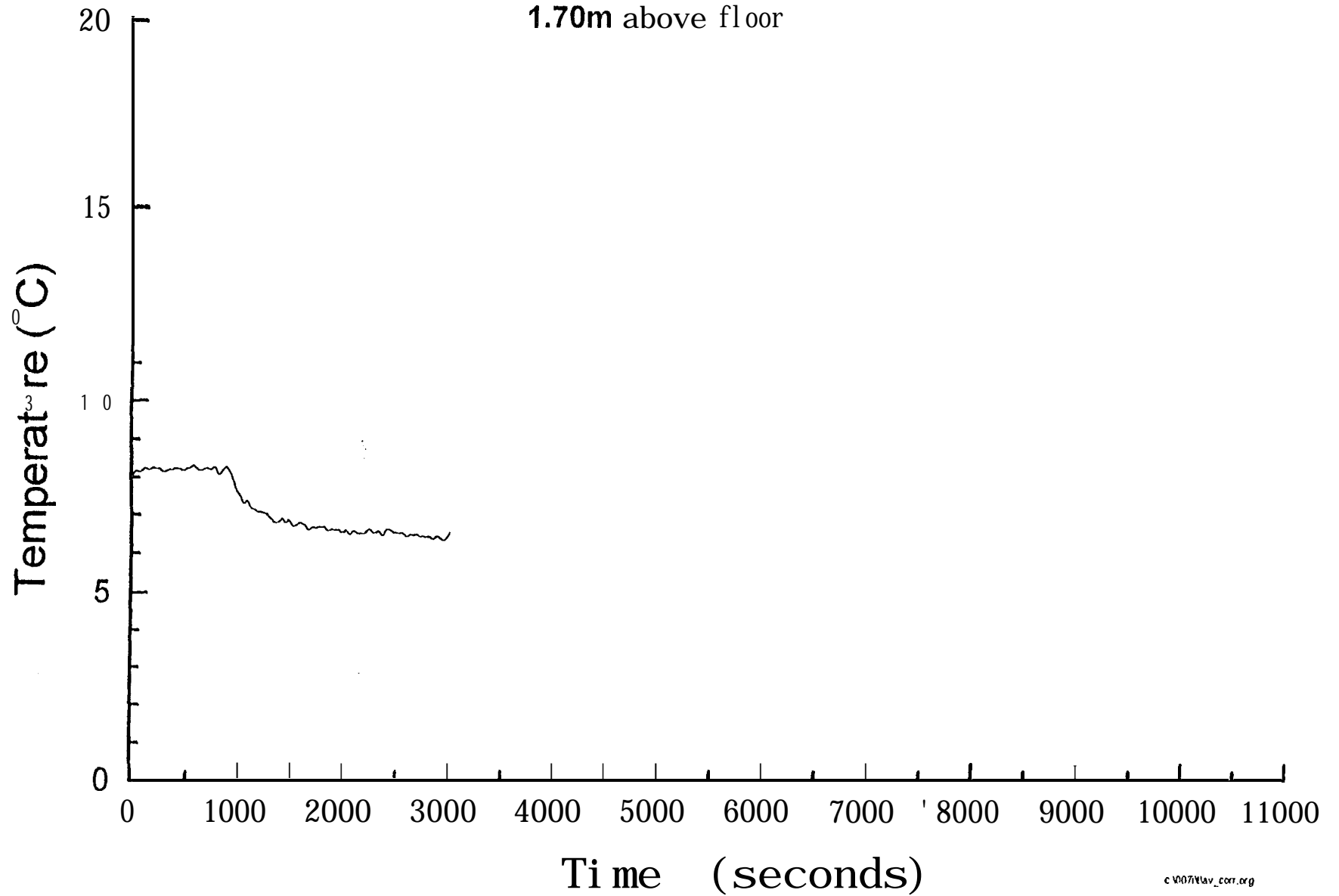

Fig. 6.2.2-21

Average temperature in corridor of level1 (Smouldering) - Test SM5

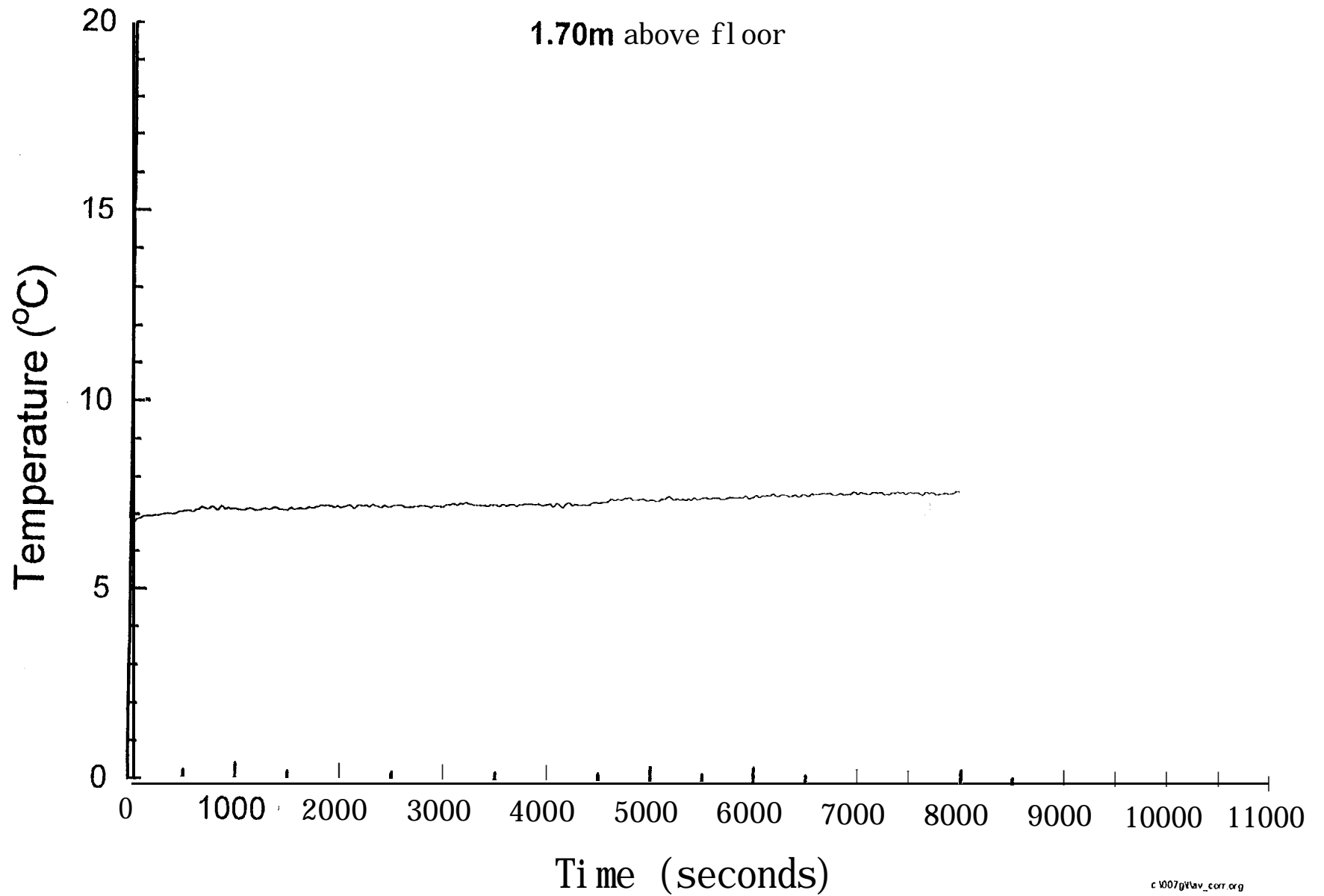

Fig. 6.2.2-22

Average temperature in corridor of level1 (Smouldering) - Test SM6

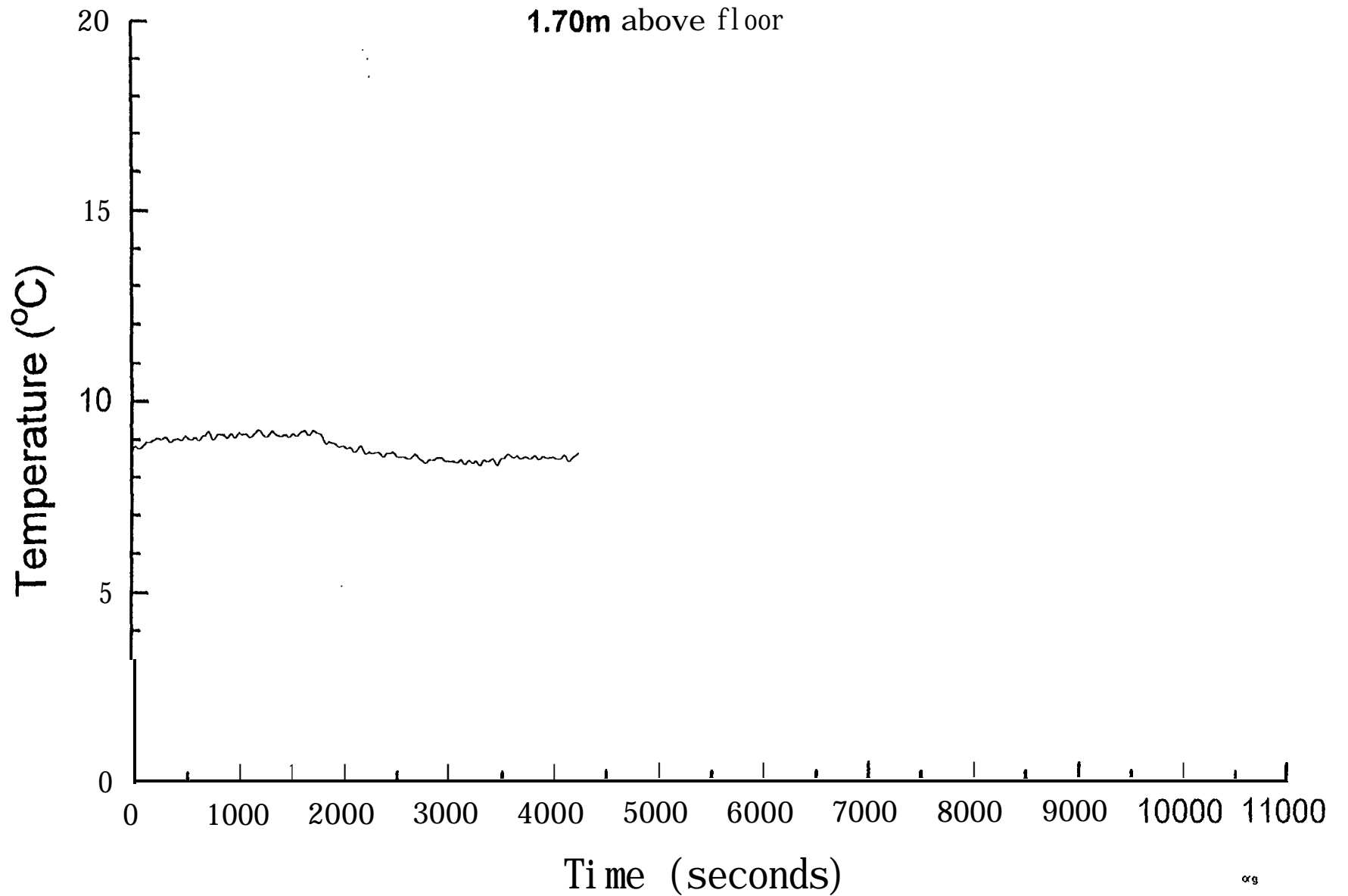

Fig. 6.2.2-23

Average temperature in corridor of level1 (Smouldering) - Test SM7

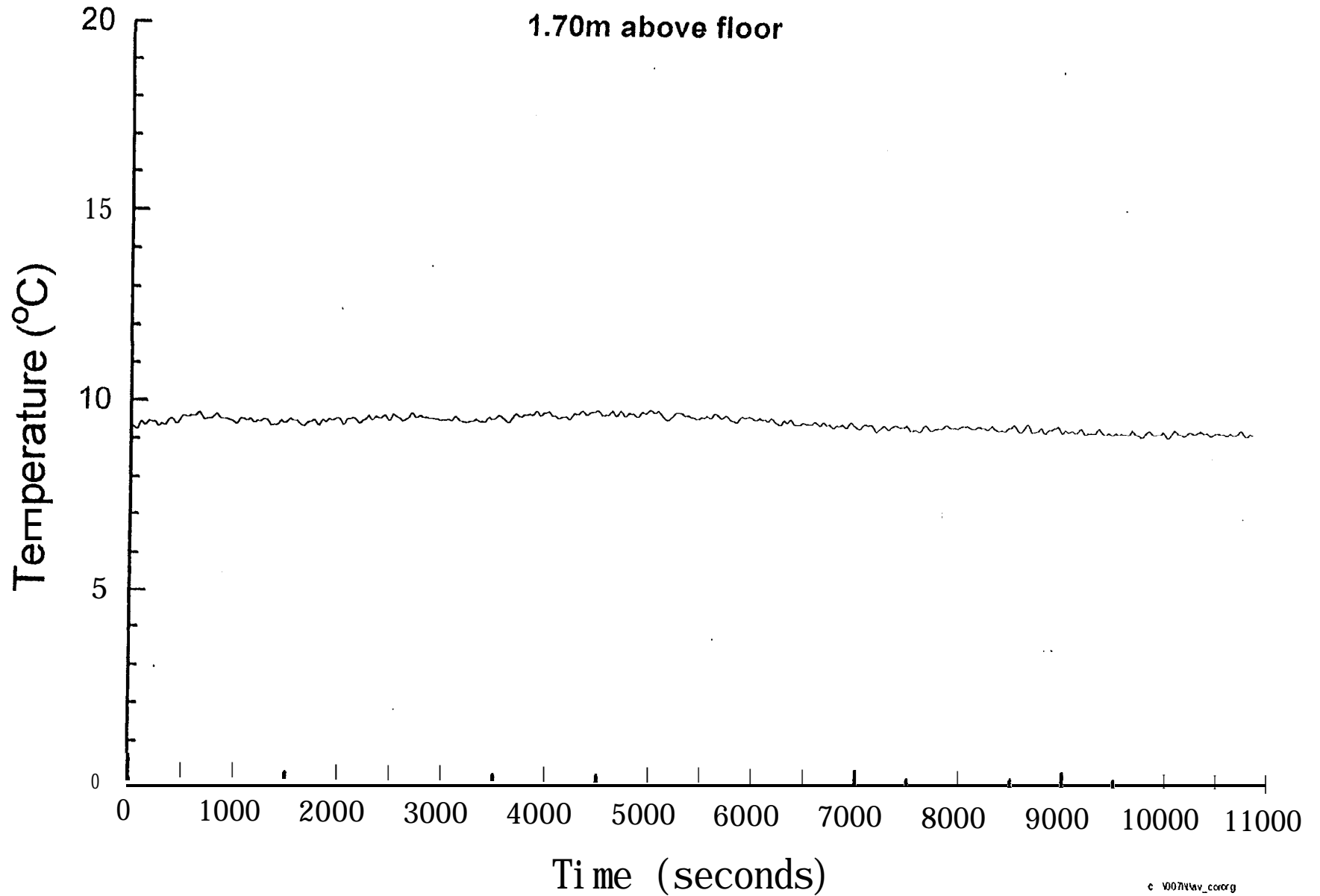

Fig. 6.2.2-24
Average temperature in corridor of level1 (Smouldering) - Test SM8

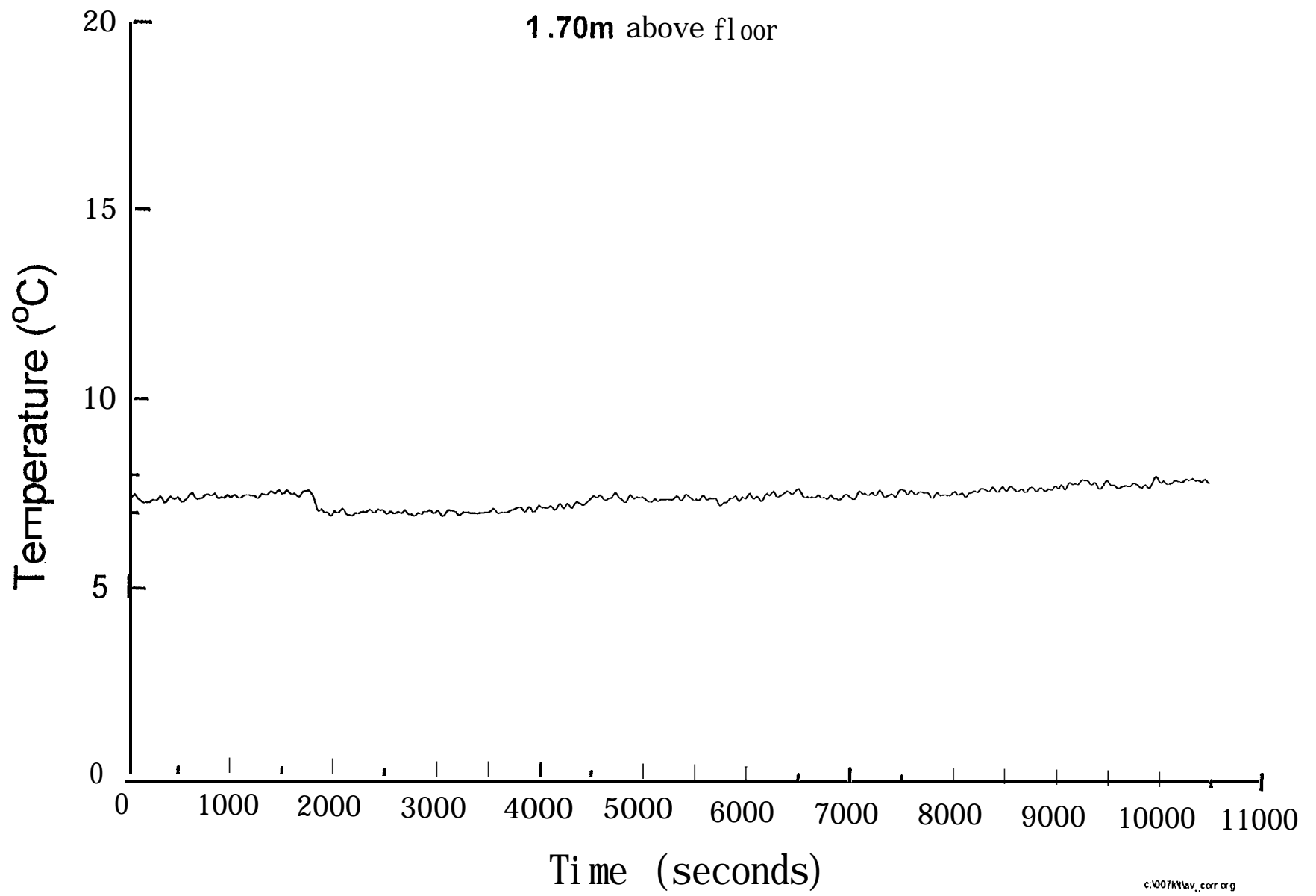

Fig. 6.2.3-1
Carbon monoxide concentration (Smouldering) - Test SM1

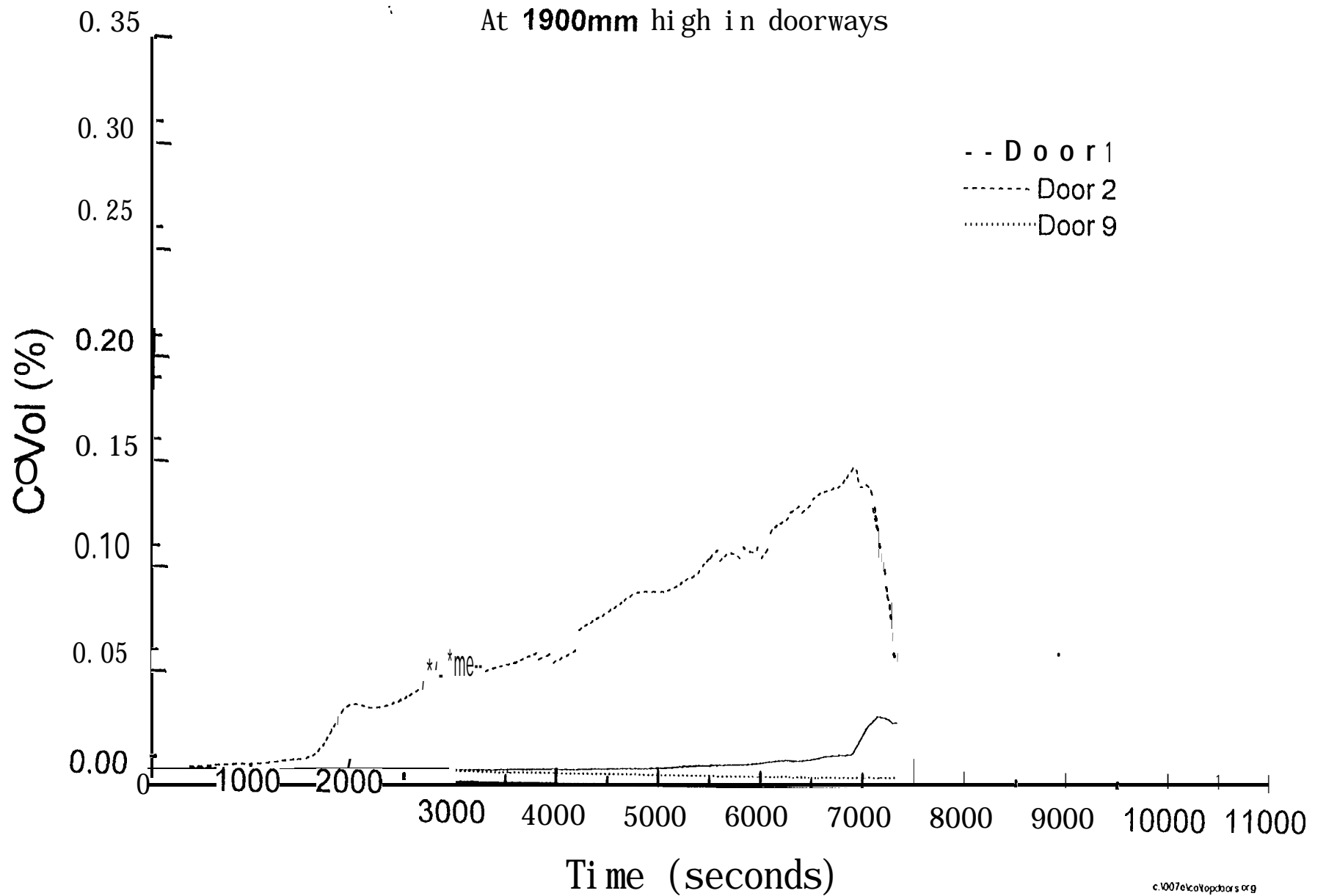

Fig. 6.2.3-2
Carbon monoxide concentration (Smouldering) - Test SM2

At 1900mm high in doorways

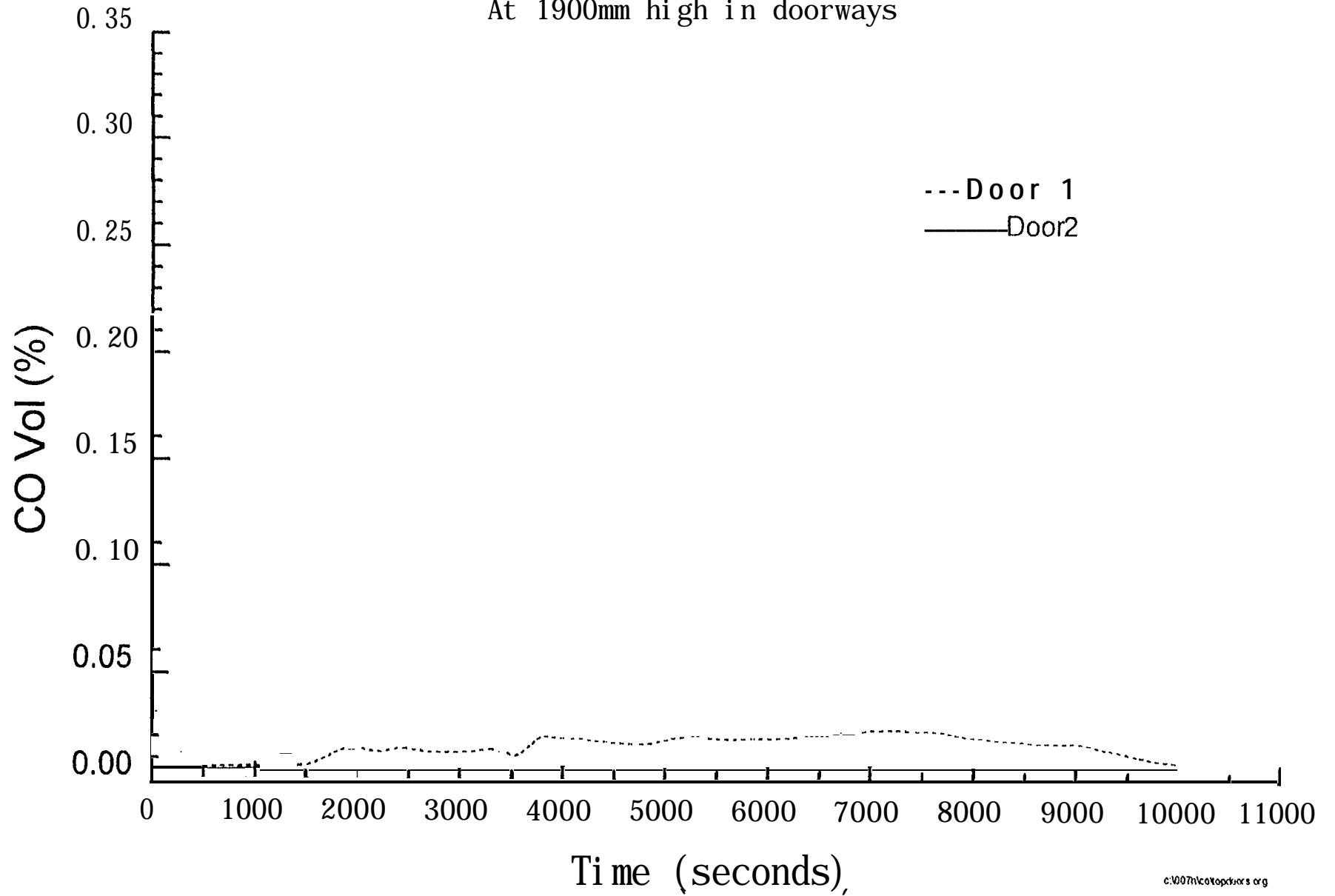

Fig. 6.2.3-3
Carbon' monoxide concentration (Smouldering) - Test SM3

At 1900mm high in doorways

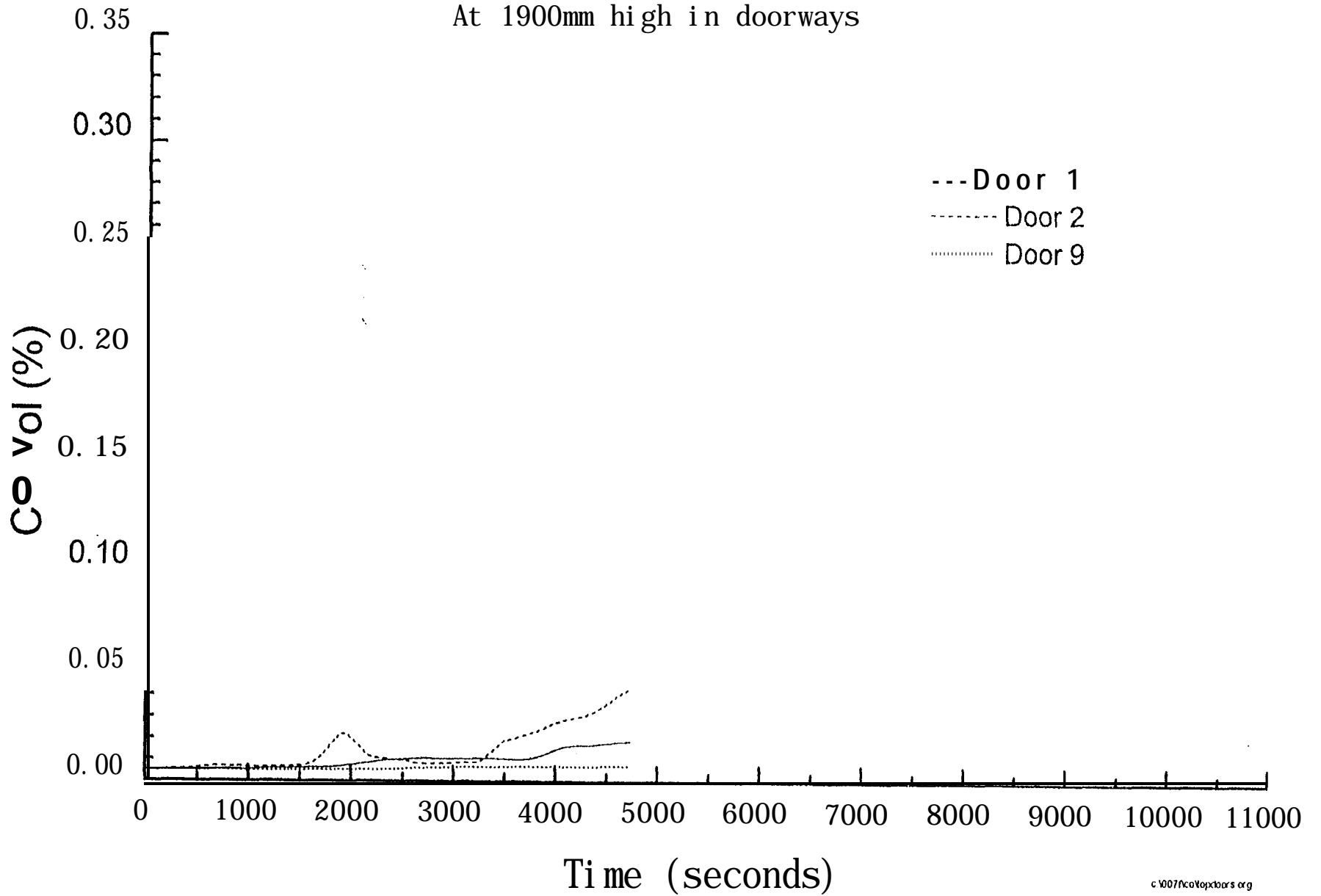

Fig. 6.2.3-4
Carbon monoxide concentration (Smouldering) - Test SM4

At 1900mm high in doorways

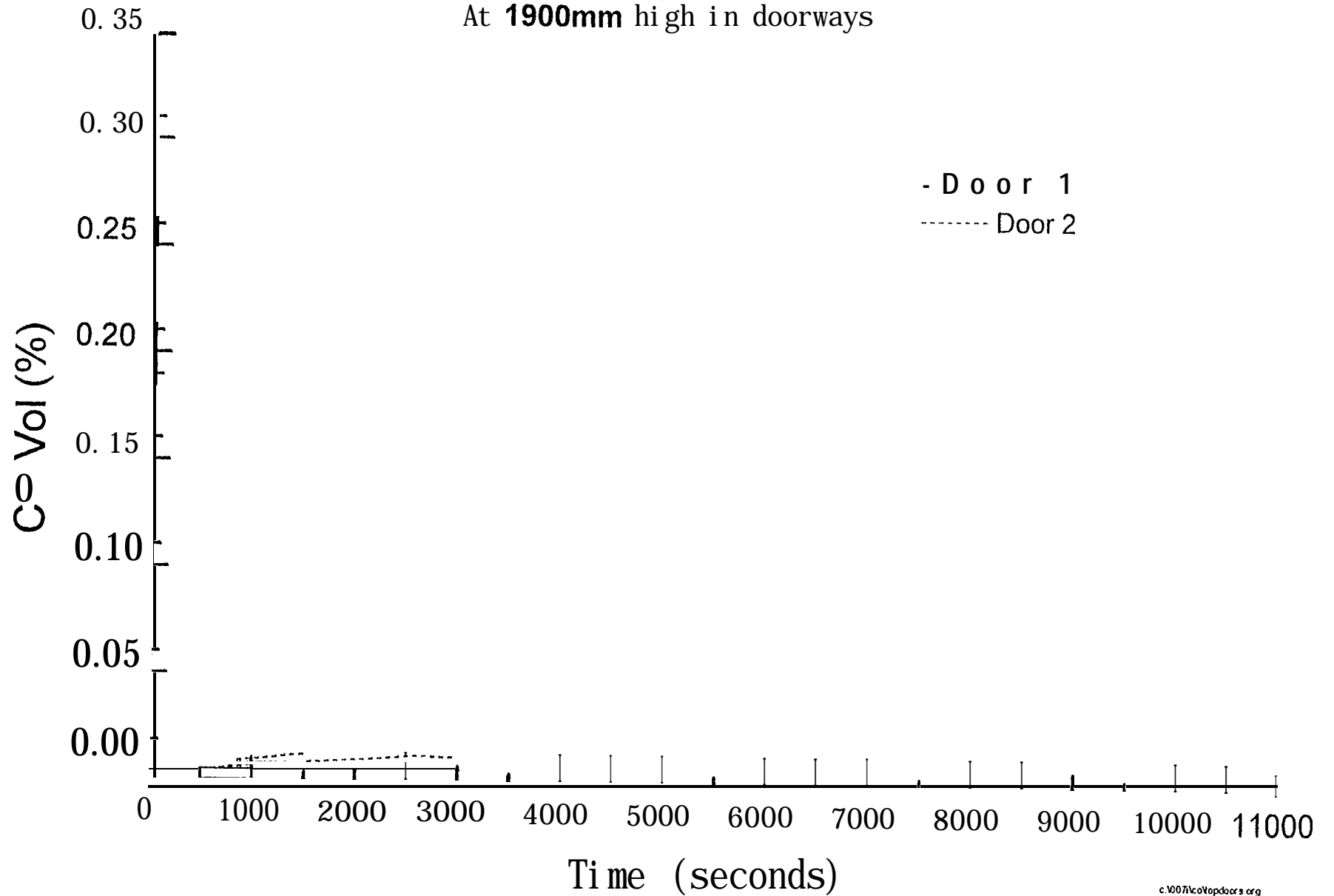

Fig. 6.2.3-5
Carbon monoxide concentration (Smouldering) - Test SM5

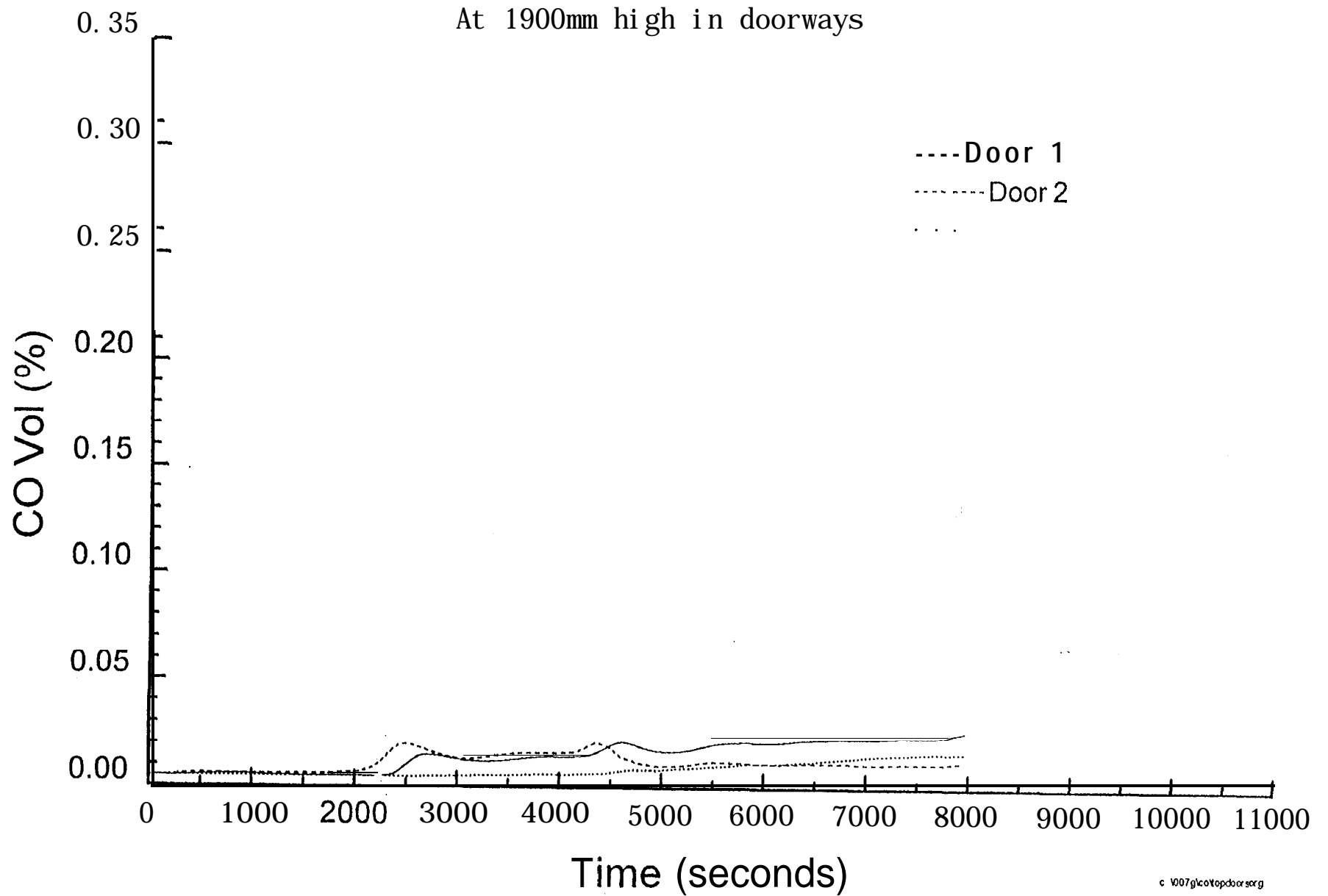

Fig. 6.2.3-6
Carbon monoxide concentration (Smouldering) - Test SM6

At 1900mm high in doorways

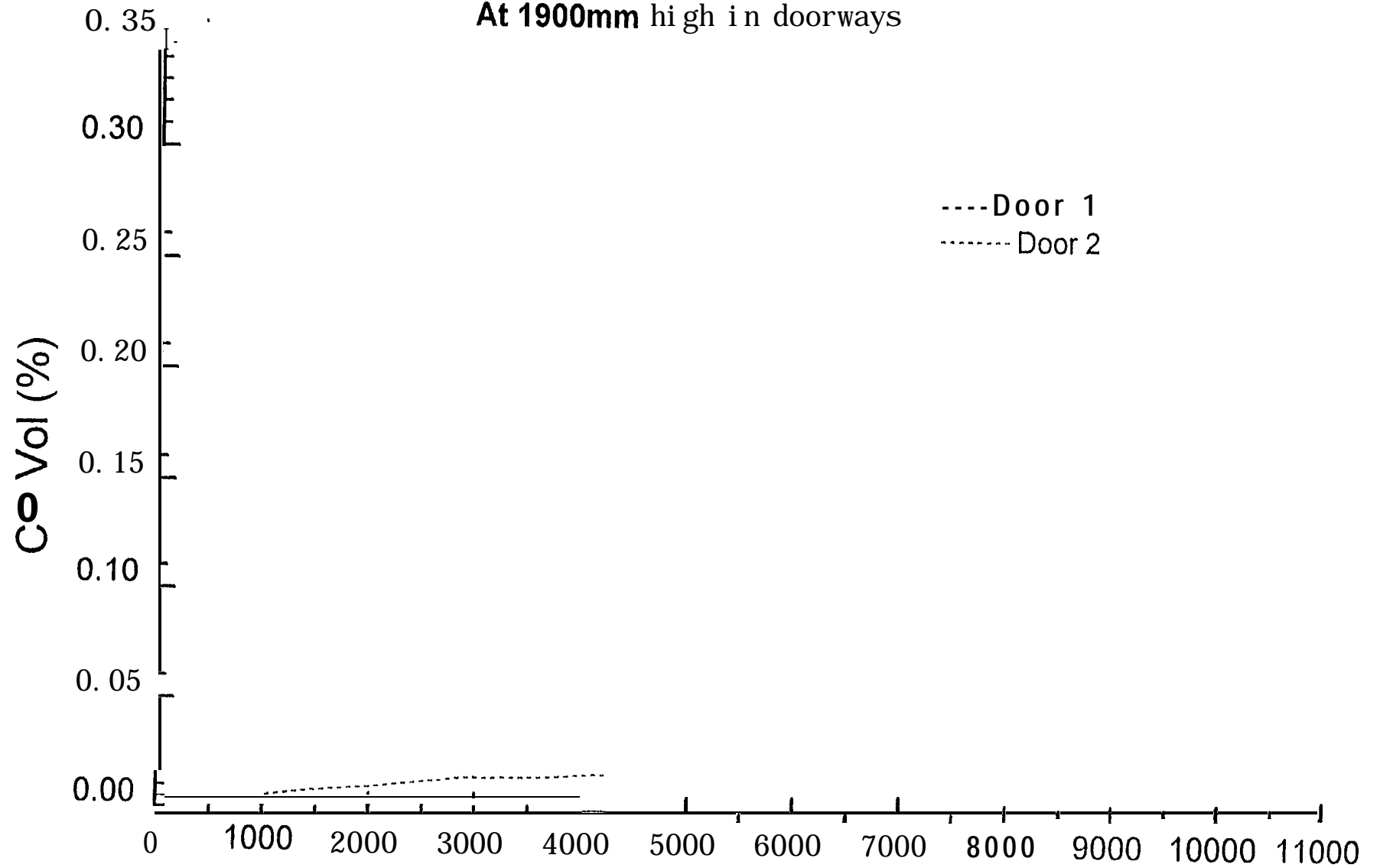

Fig. 6.2.3-7
Carbon monoxide concentration (Smouldering) - Test SM7

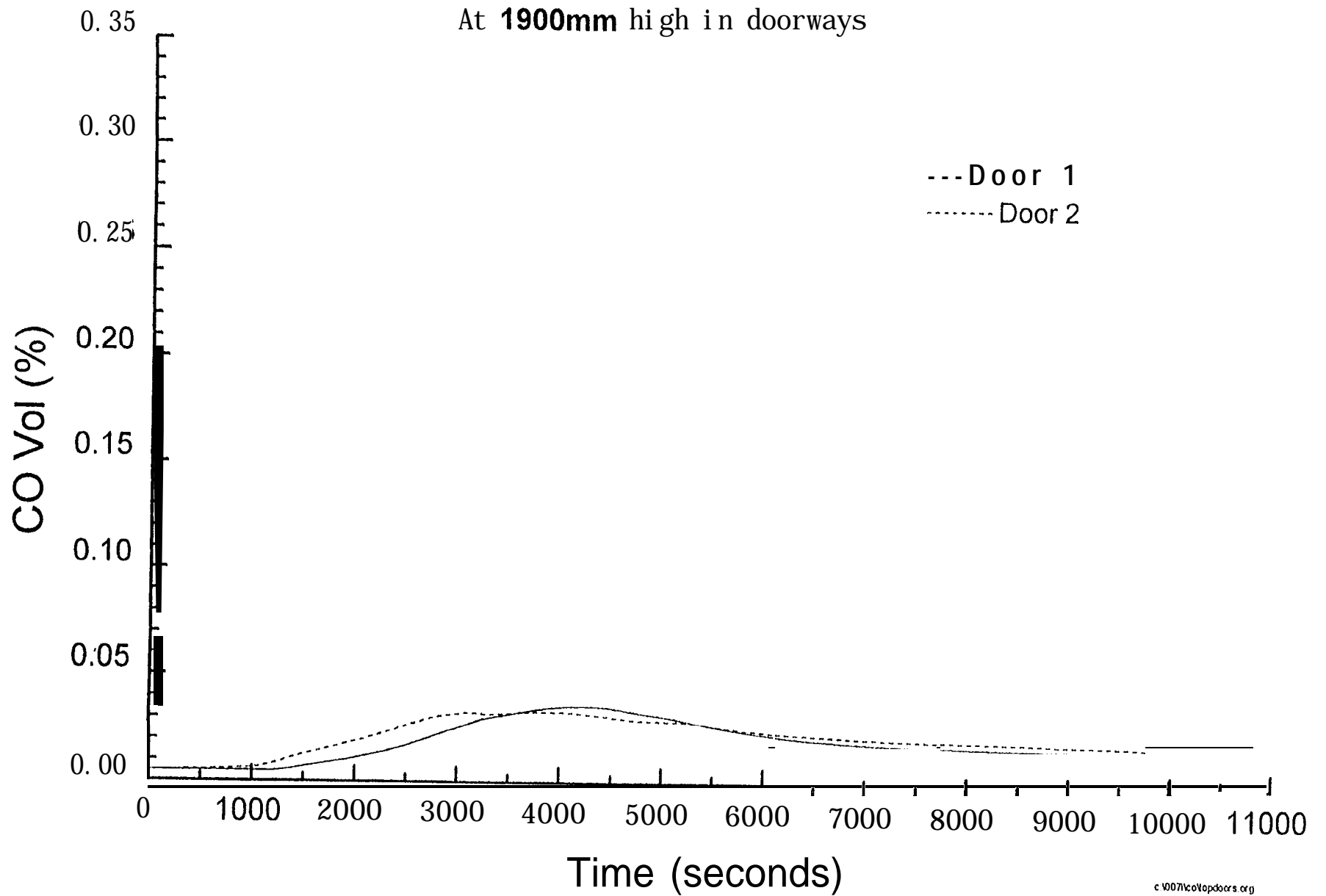

Fig. 6.2.3-8
Carbon monoxide concentration (Smouldering) - Test SM8

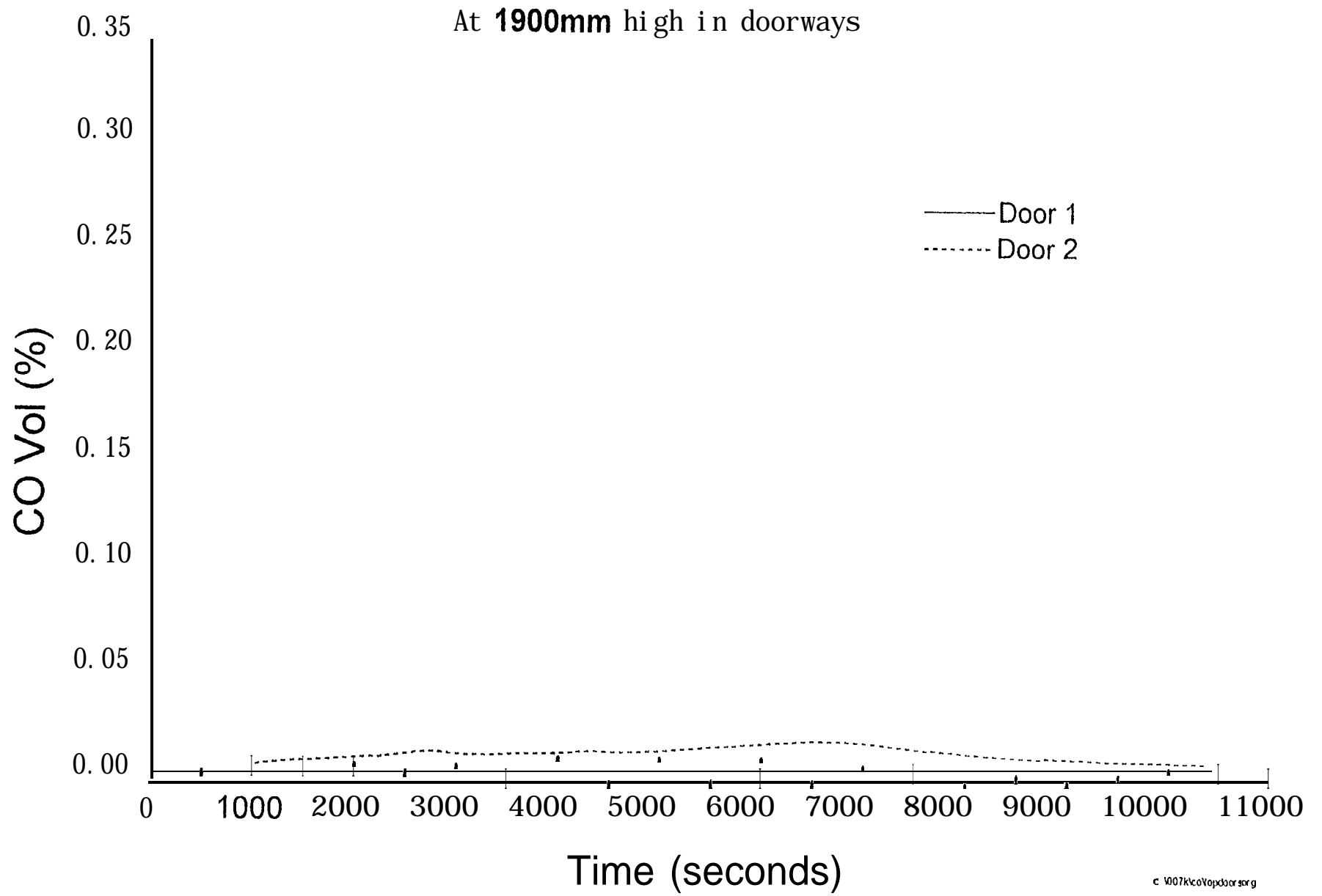

Fig. 6.2.4-I
Oxygen concentration (Smouldering) - Test SM1

At various heights in Door 2

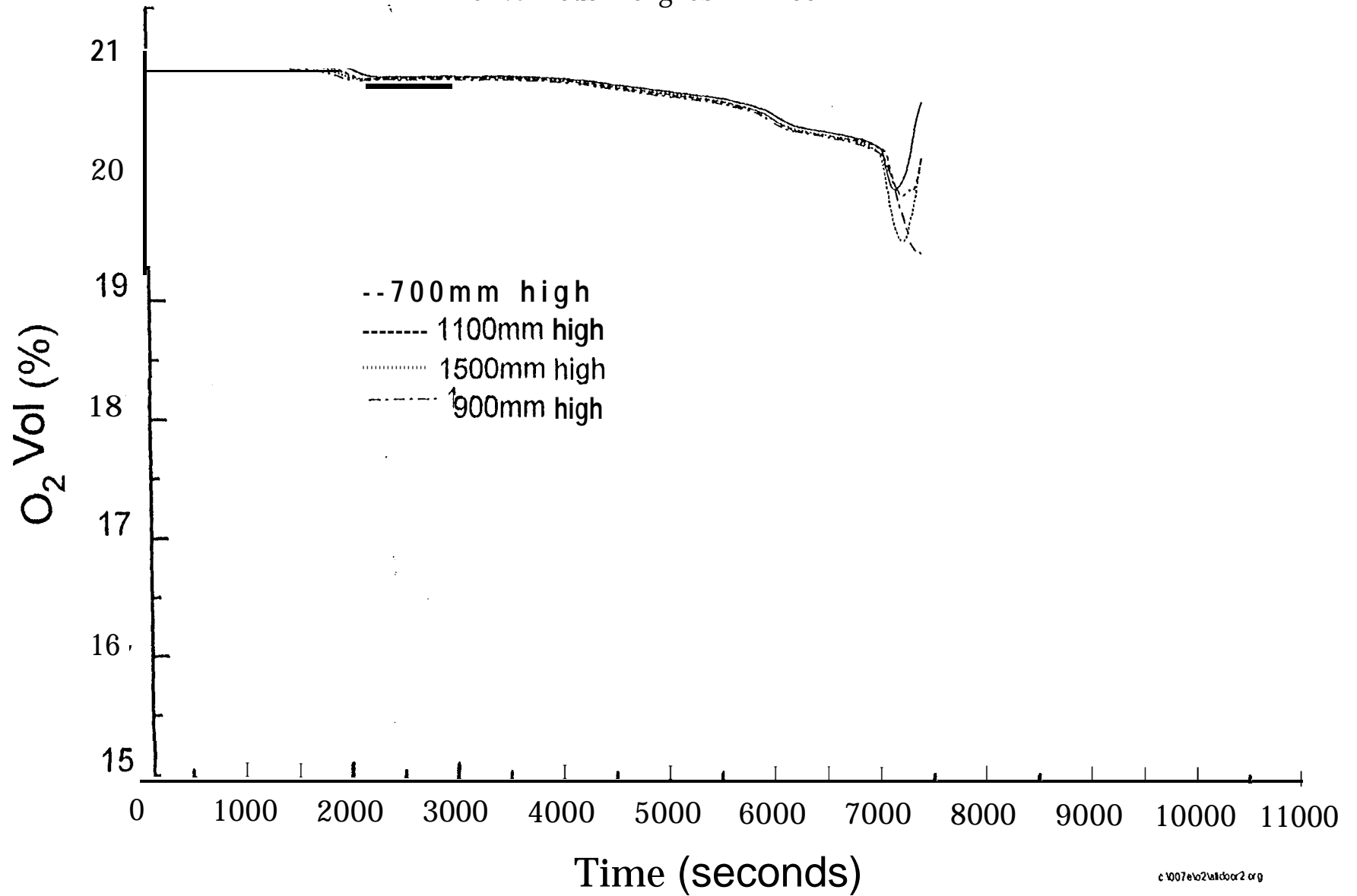

Fig. 6.2.4-2
Oxygen concentration (Smouldering) - Test SM2

At various heights in Door 2

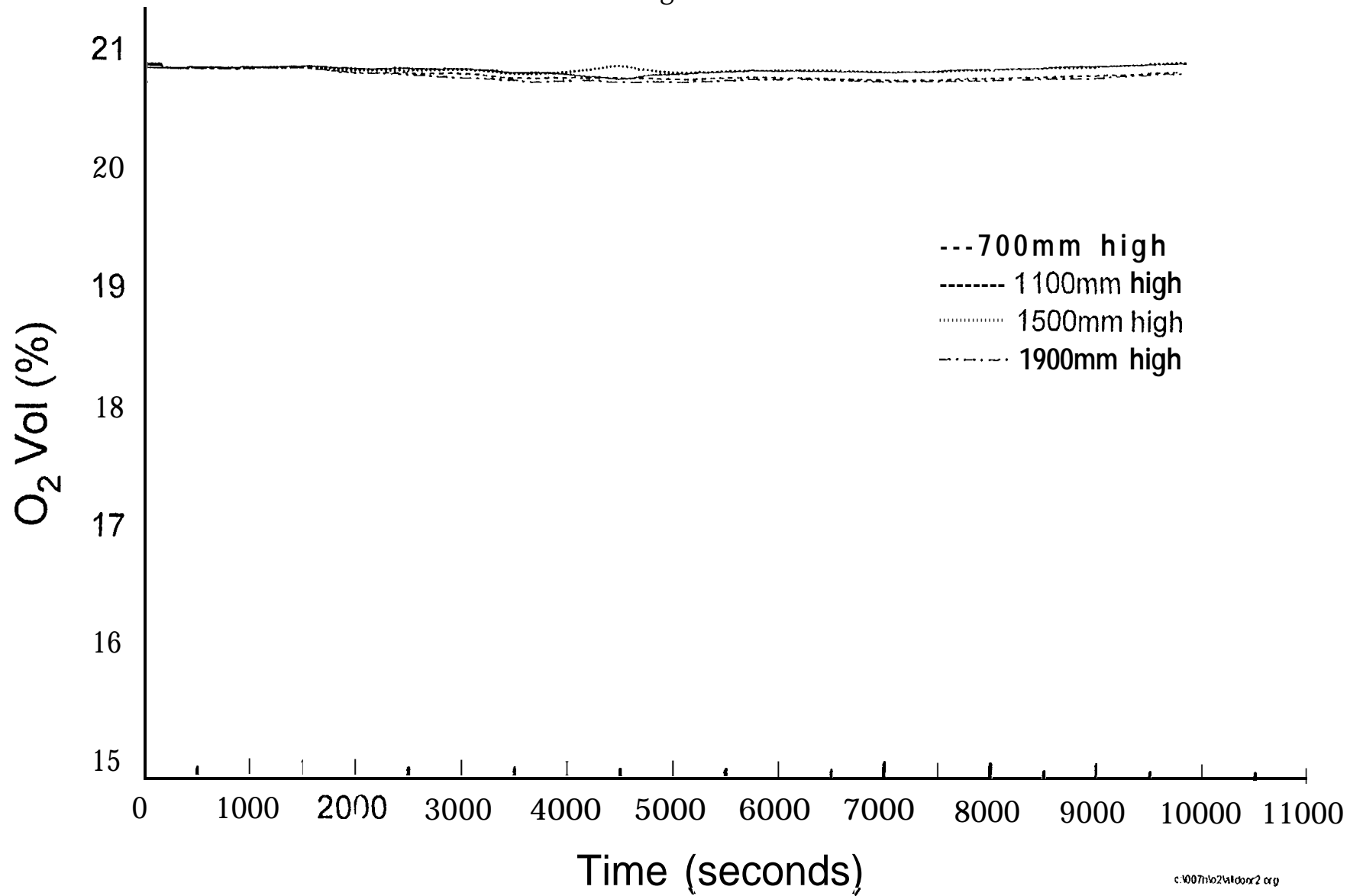

Fig. 6.2.4-3
Oxygen concentration (Smouldering) - Test SM3

At various heights in Door 2

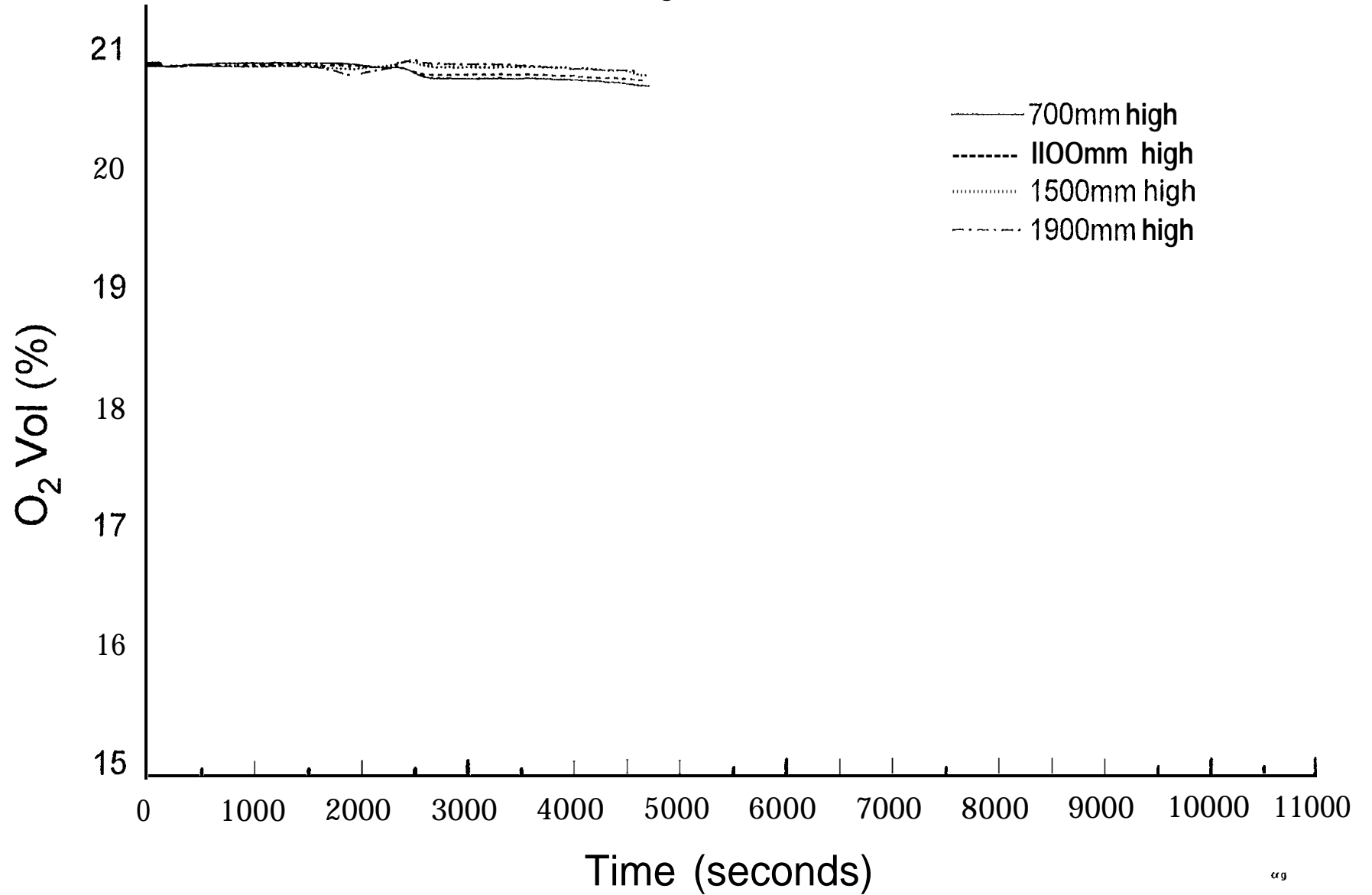

Fig. 6.2.4-4
Oxygen concentration (Smouldering) - Test SM4

At various heights in Door 2

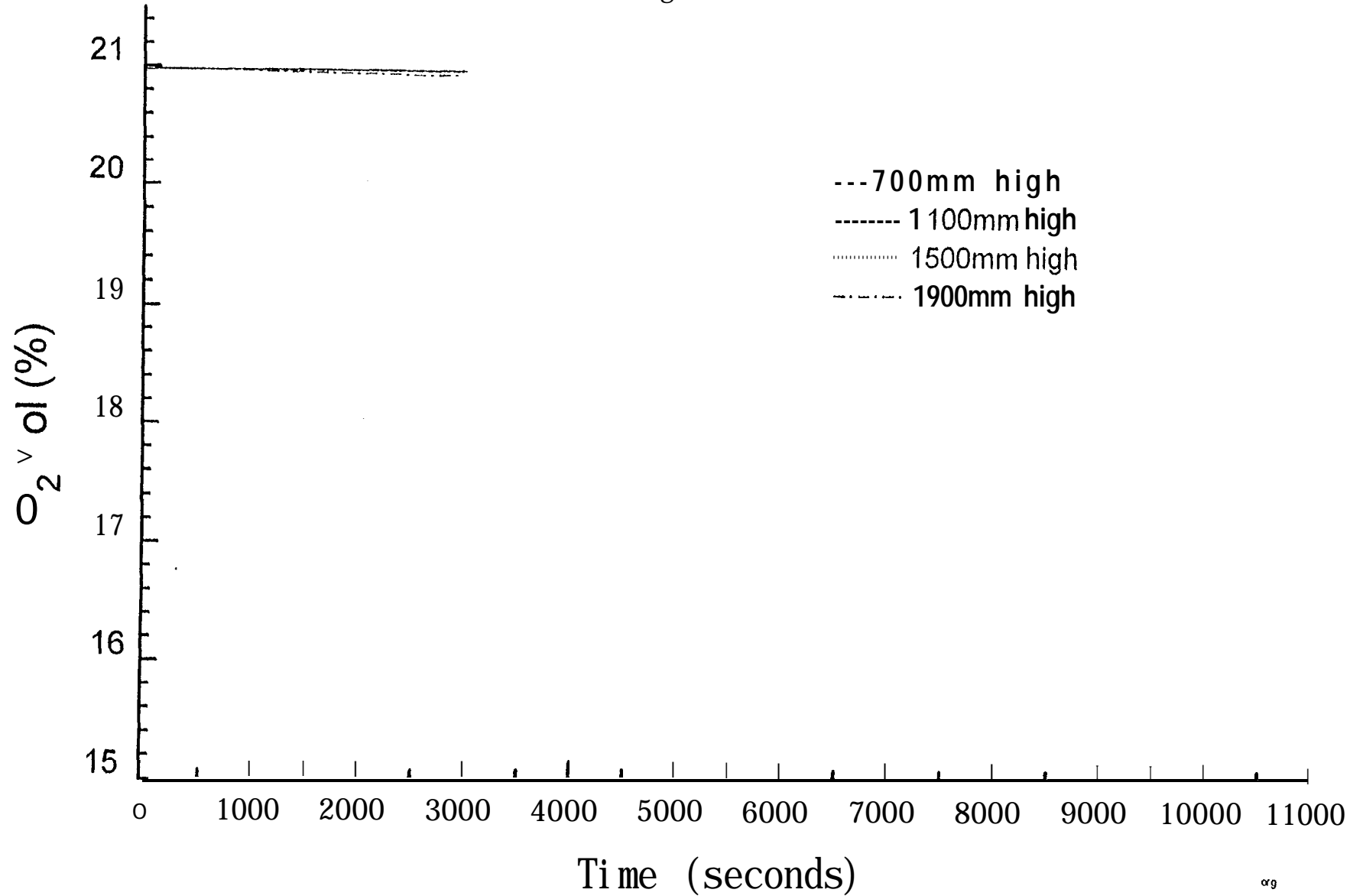
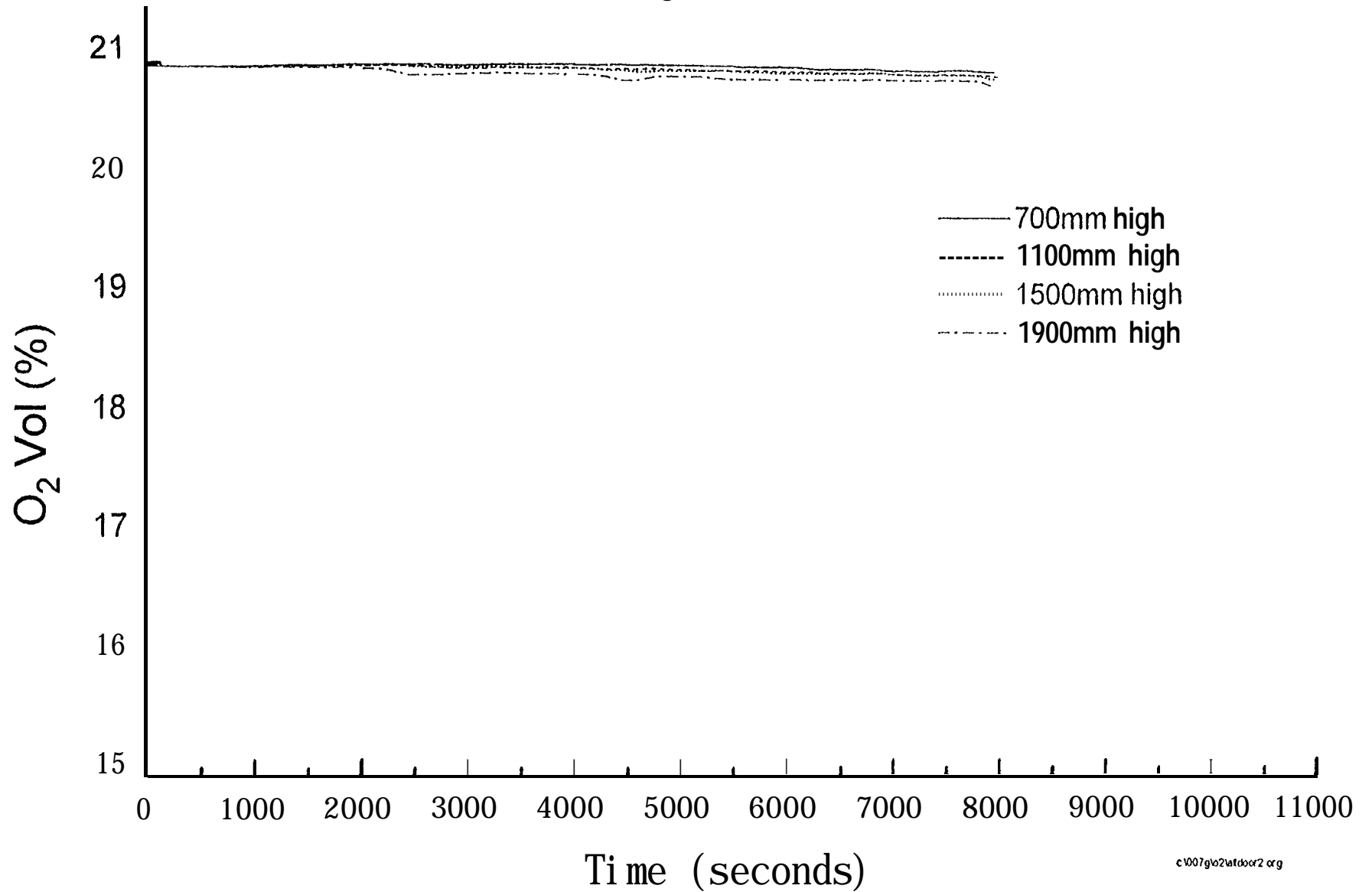

Fig. 6.2.4-5
Oxygen concentration (Smouldering) - Test SM5

At various heights in Door 2



c:\07g\o2atdoor2.org

Fig. 6.2.4-6
Oxygen concentration (Smouldering) - Test SM6

At various heights in Door 2

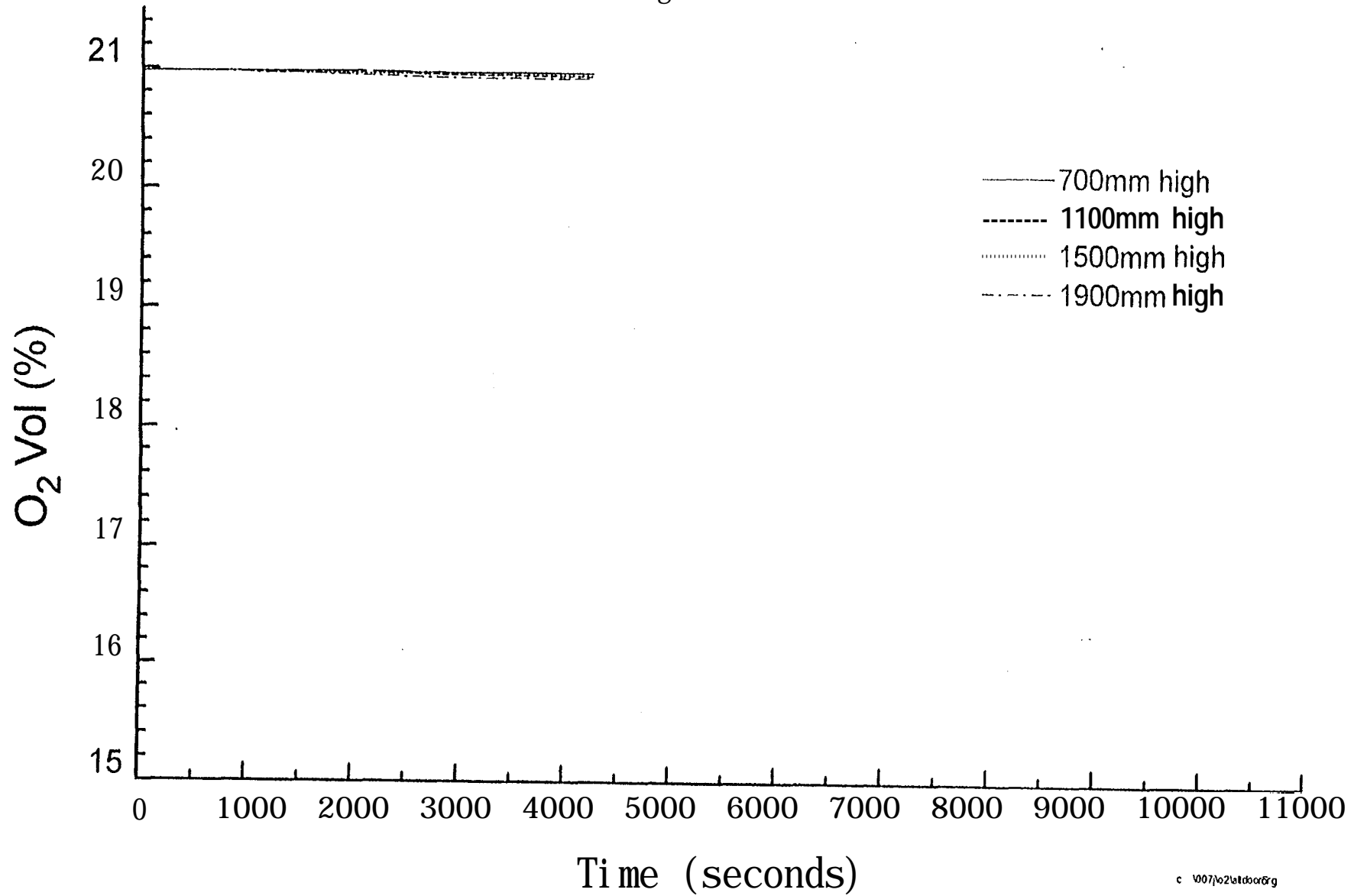

Fig. 6.2.4-7
Oxygen concentration (Smouldering) - Test SM7

At various heights in Door 2

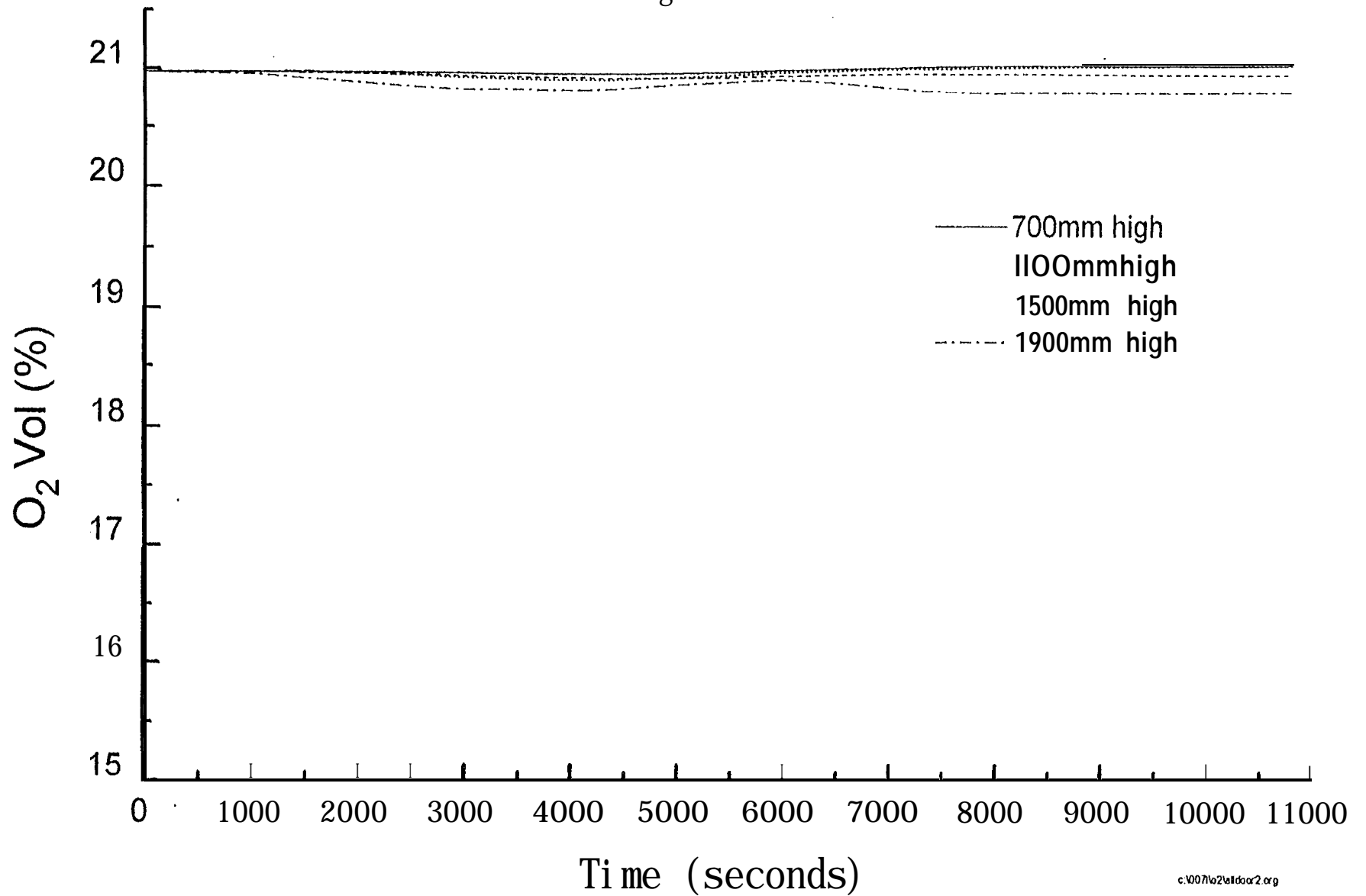

Fig. 6.251
Carbon dioxide concentration (Smouldering) - Test SM1

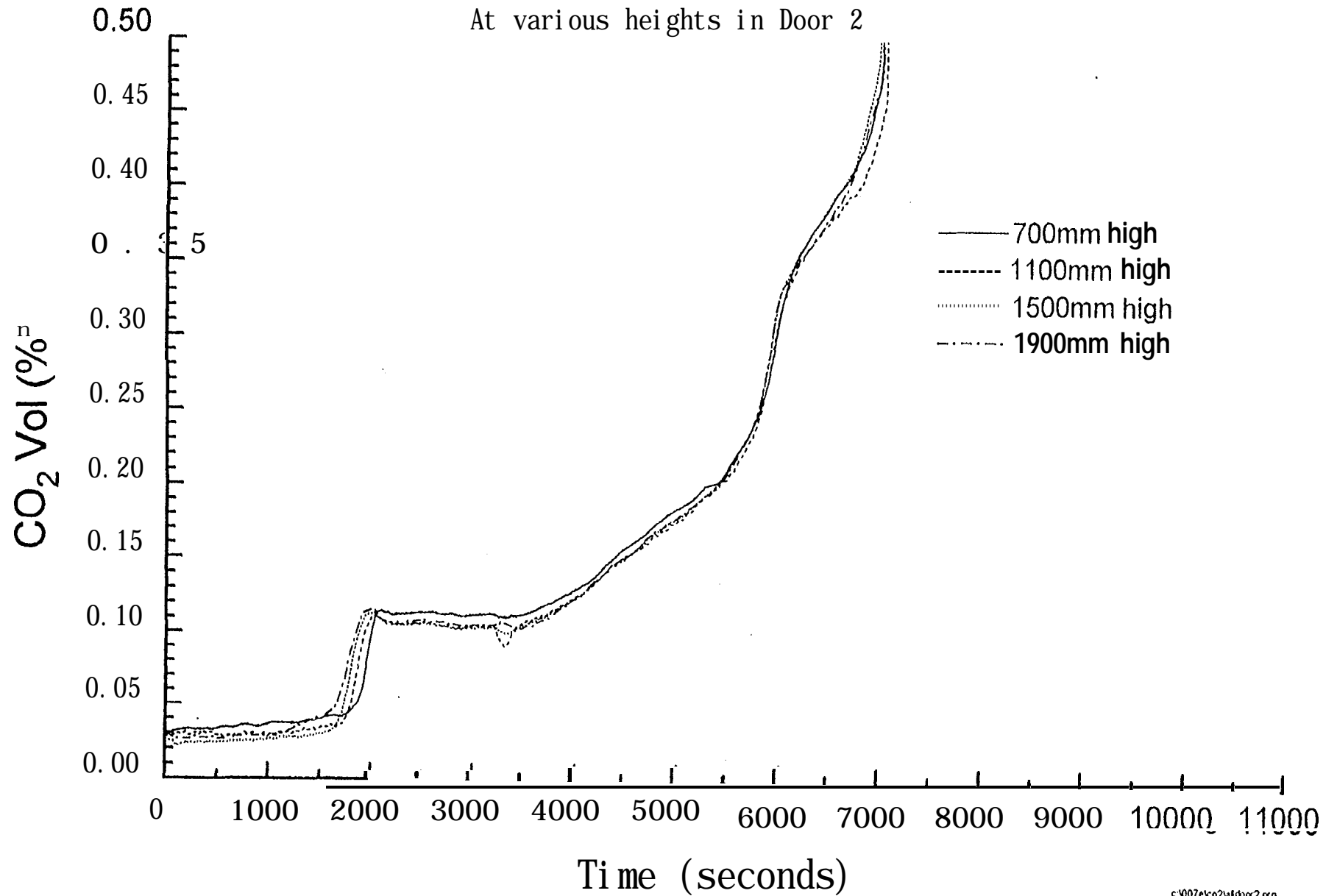

Fig. 6.2.5-2

Carbon dioxide concentration (Smouldering) - Test SM2

At various heights in Door 2

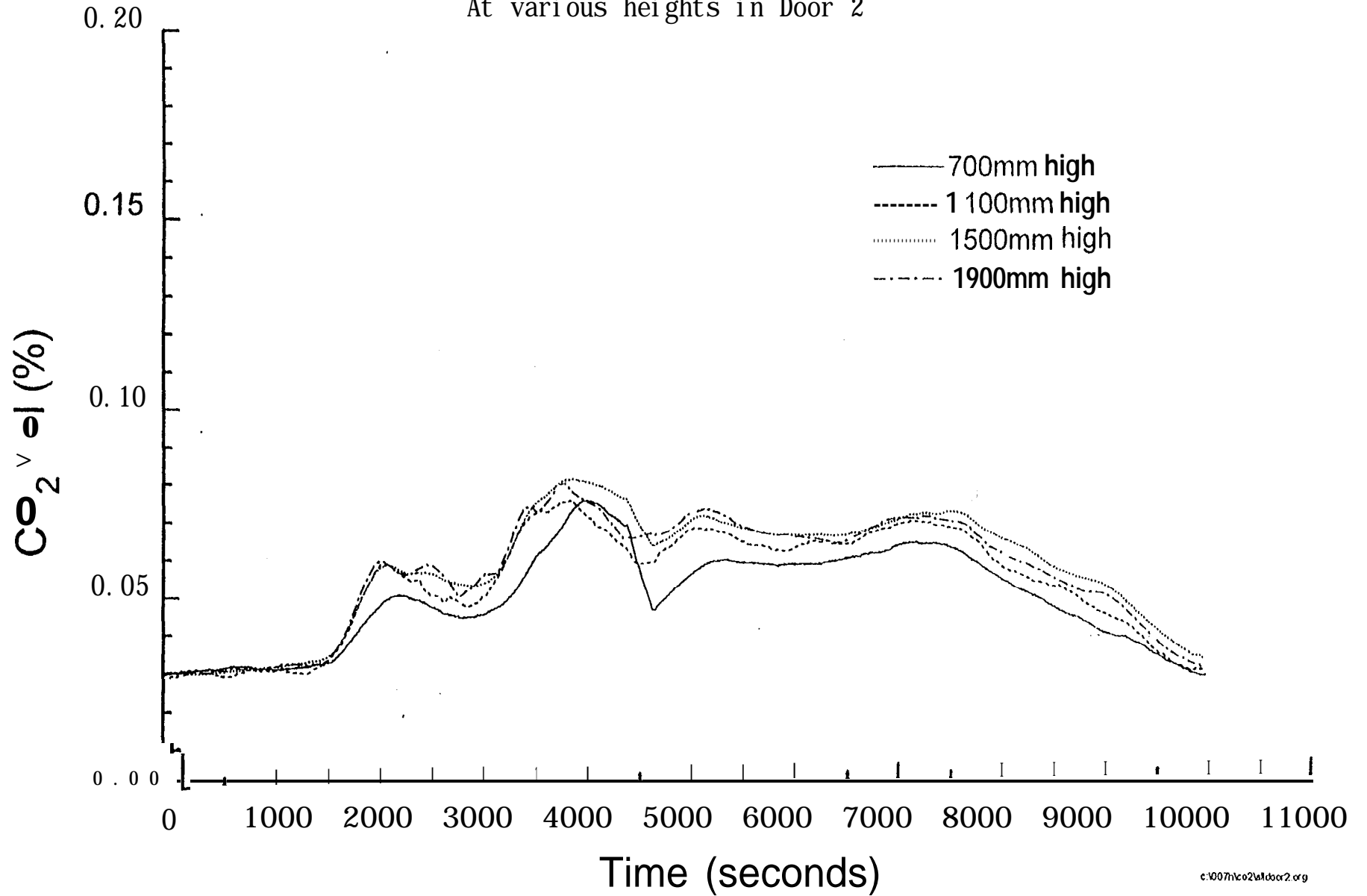

Fig. 6.2.5-3
Carbon dioxide concentration (Smouldering) - Test SM4

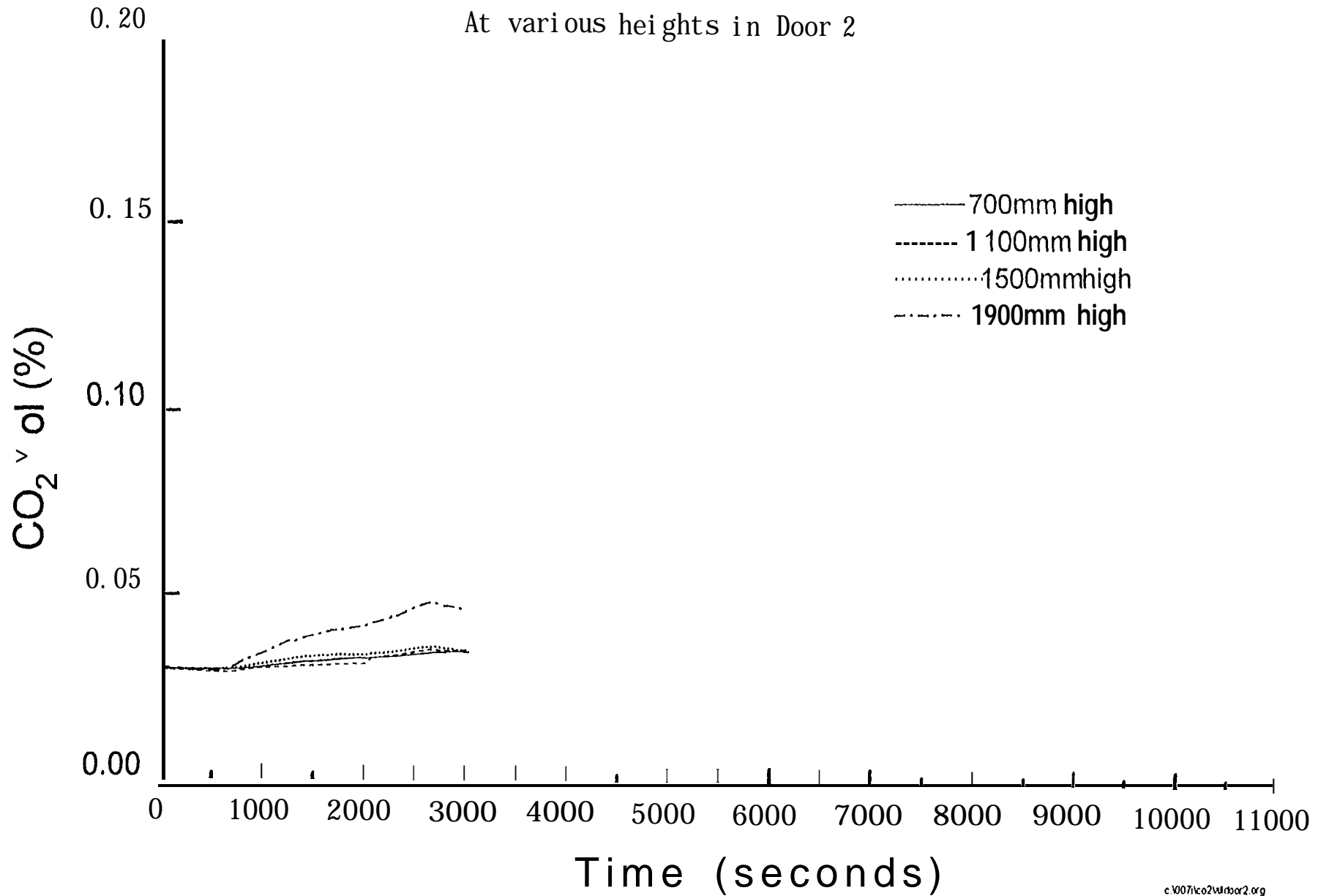

Fig. 6.2.5-4
Carbon dioxide concentration (Smouldering) - Test SM5

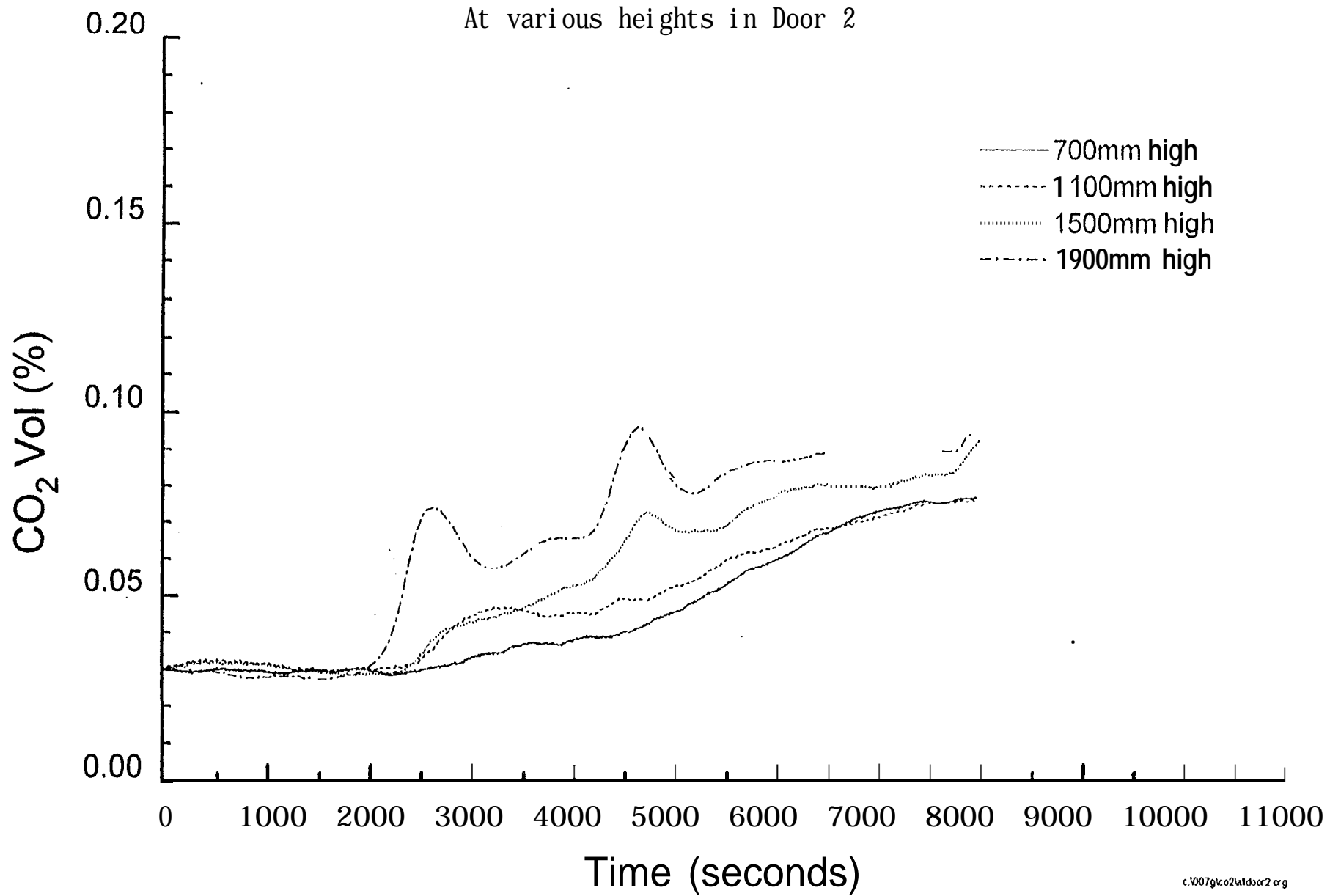

Fig. 6.2.5-5
Carbon dioxide concentration (Smouldering) - Test SM6

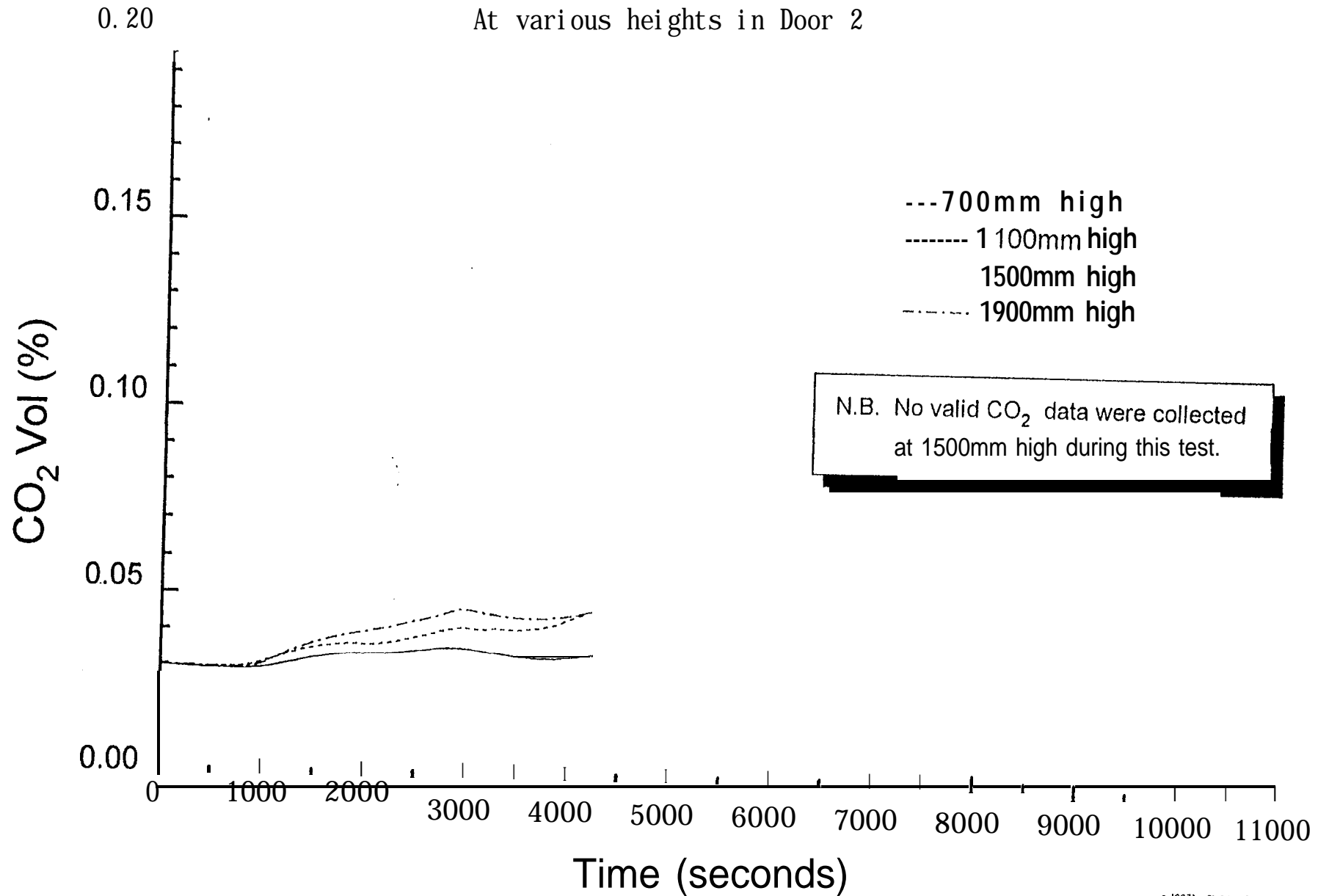

Fig. 6.2.5-6
Carbon dioxide concentration (Smouldering) - Test SM7

At various heights in Door 2

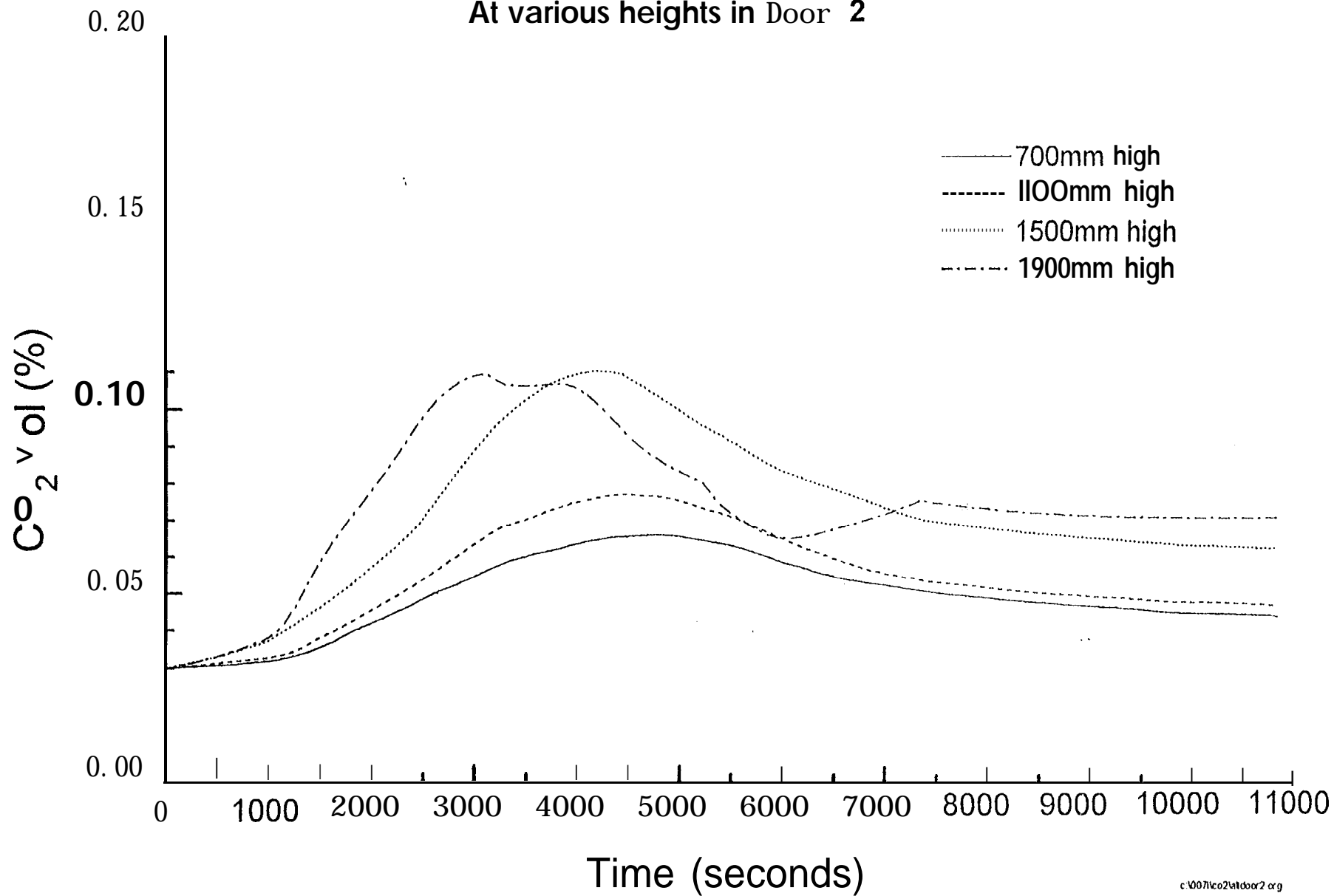

Fig. 6.2.5-7
Carbon dioxide concentration (Smouldering) - Test SM8

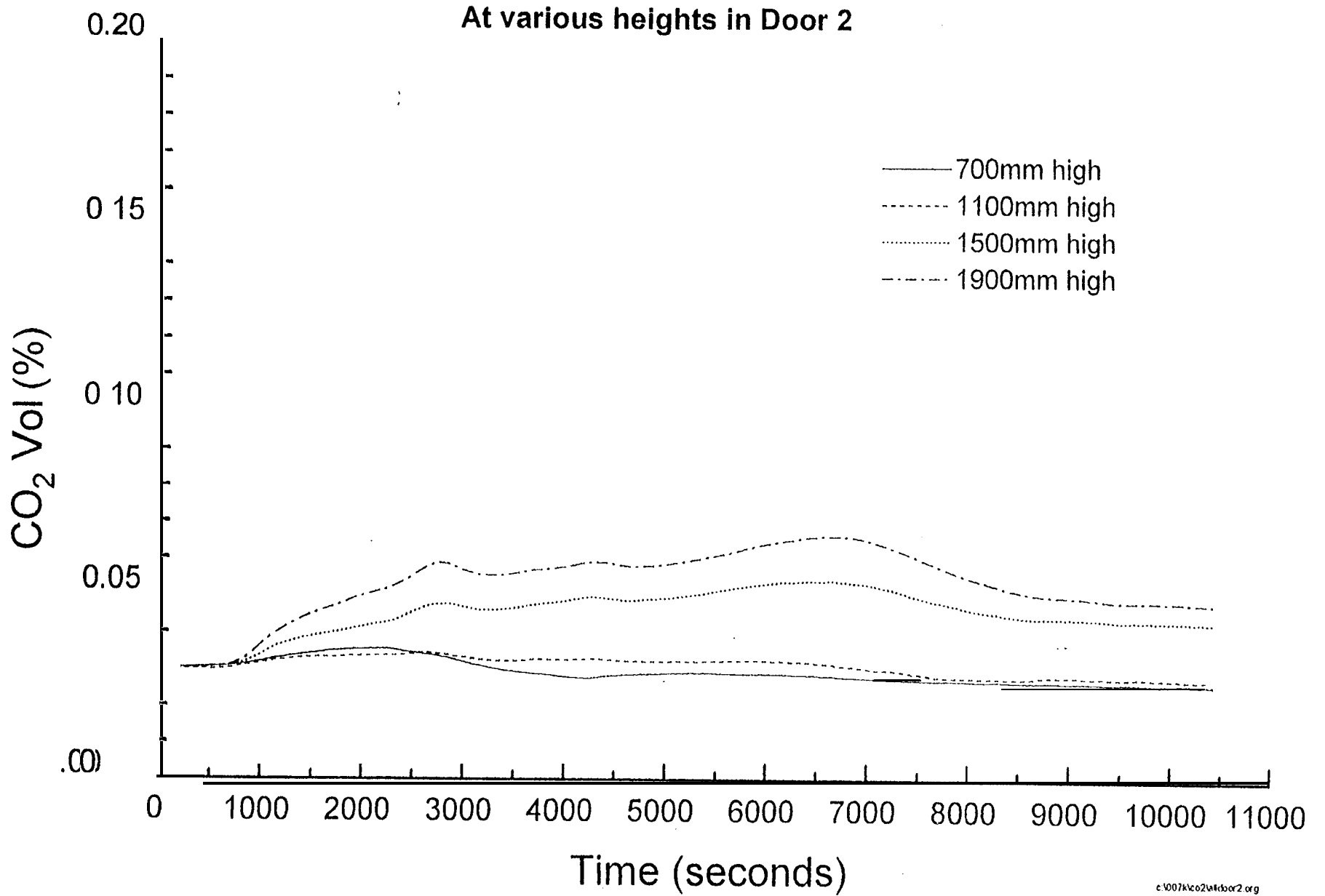

Fig. 6.2.6-1
Air velocity (Smouldering) - Test SM8
Through door 9

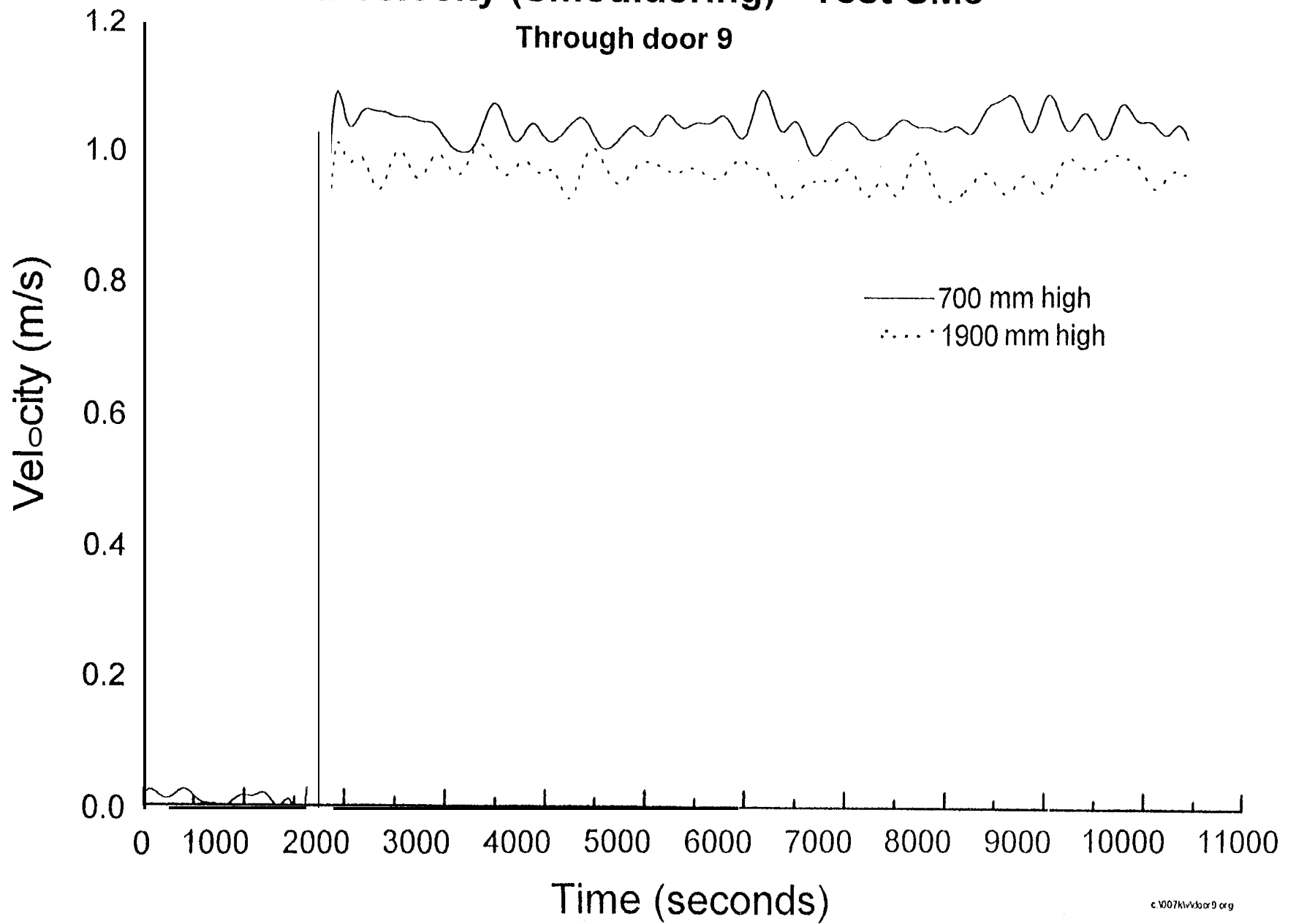

Fig. 6.2.7-1

Smoke obscuration and temperature (smouldering) - Test SM1

Centre of room 101 ceiling

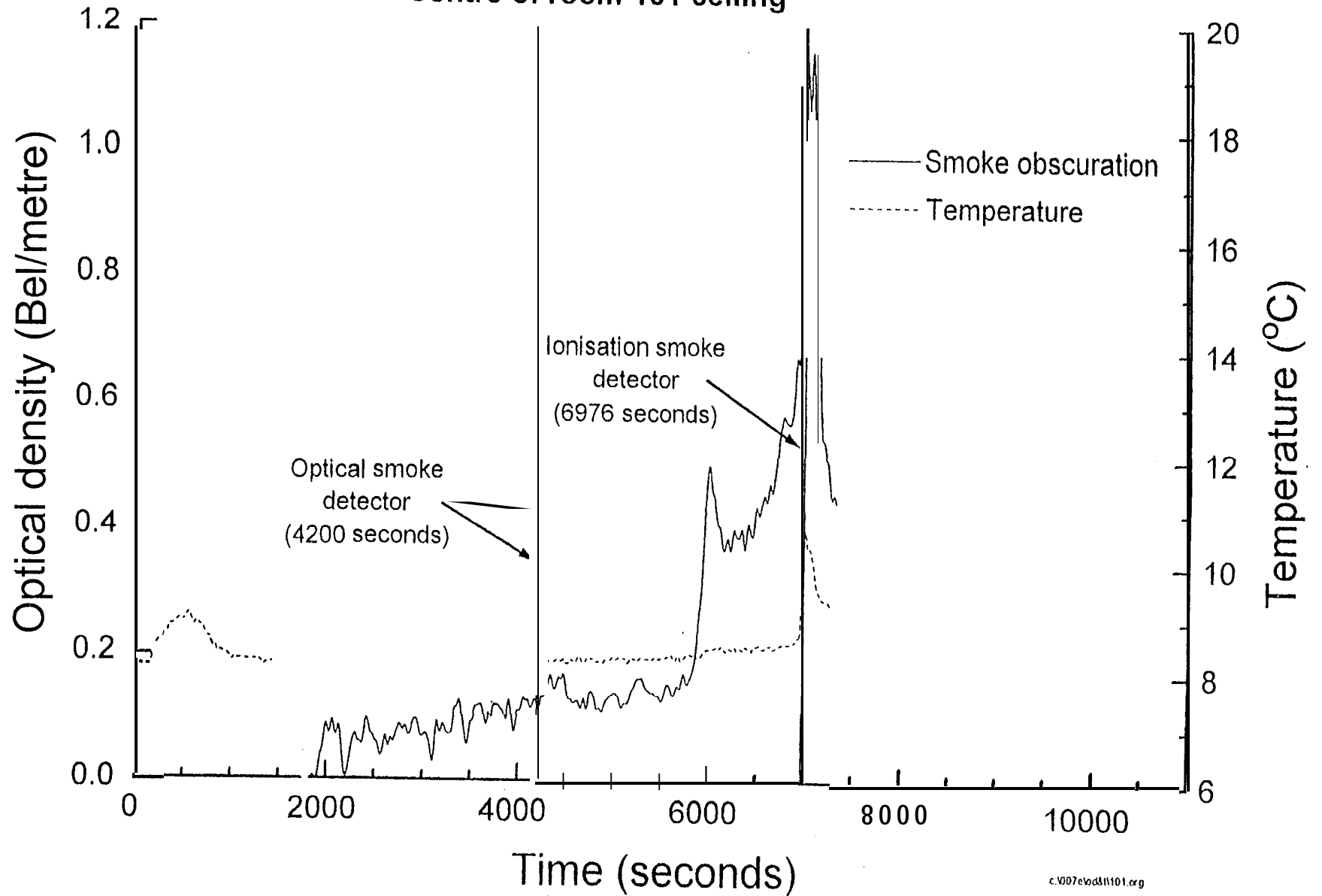
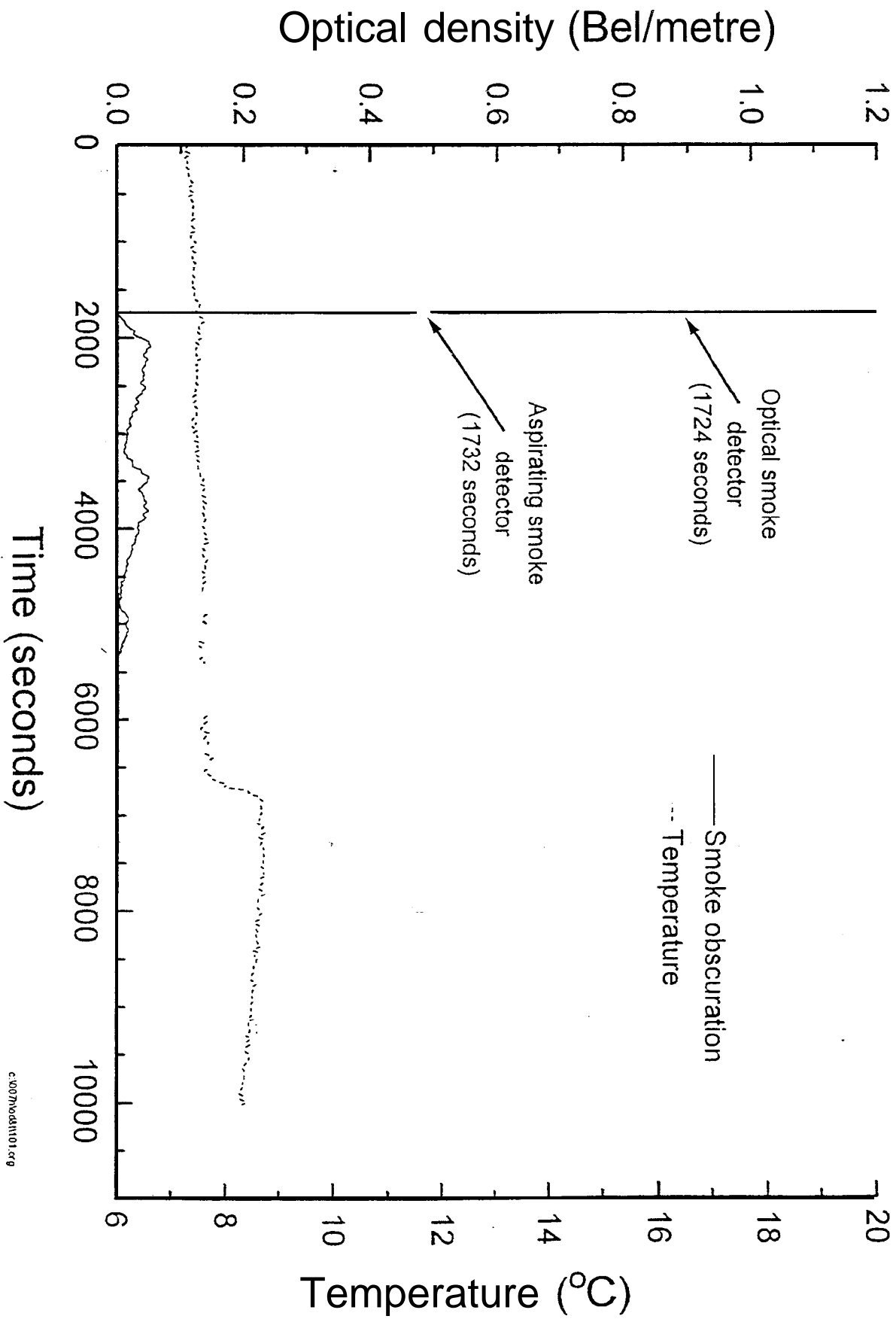

Fig. 6.2.7-2

Smoke obscuration and temperature (smouldering) - Test SM2

Centre of room 101 ceiling



Smoke obscuration and temperature (smouldering) - Test SM3

Fig. 6.2.7-3

Centre of room 101 ceiling

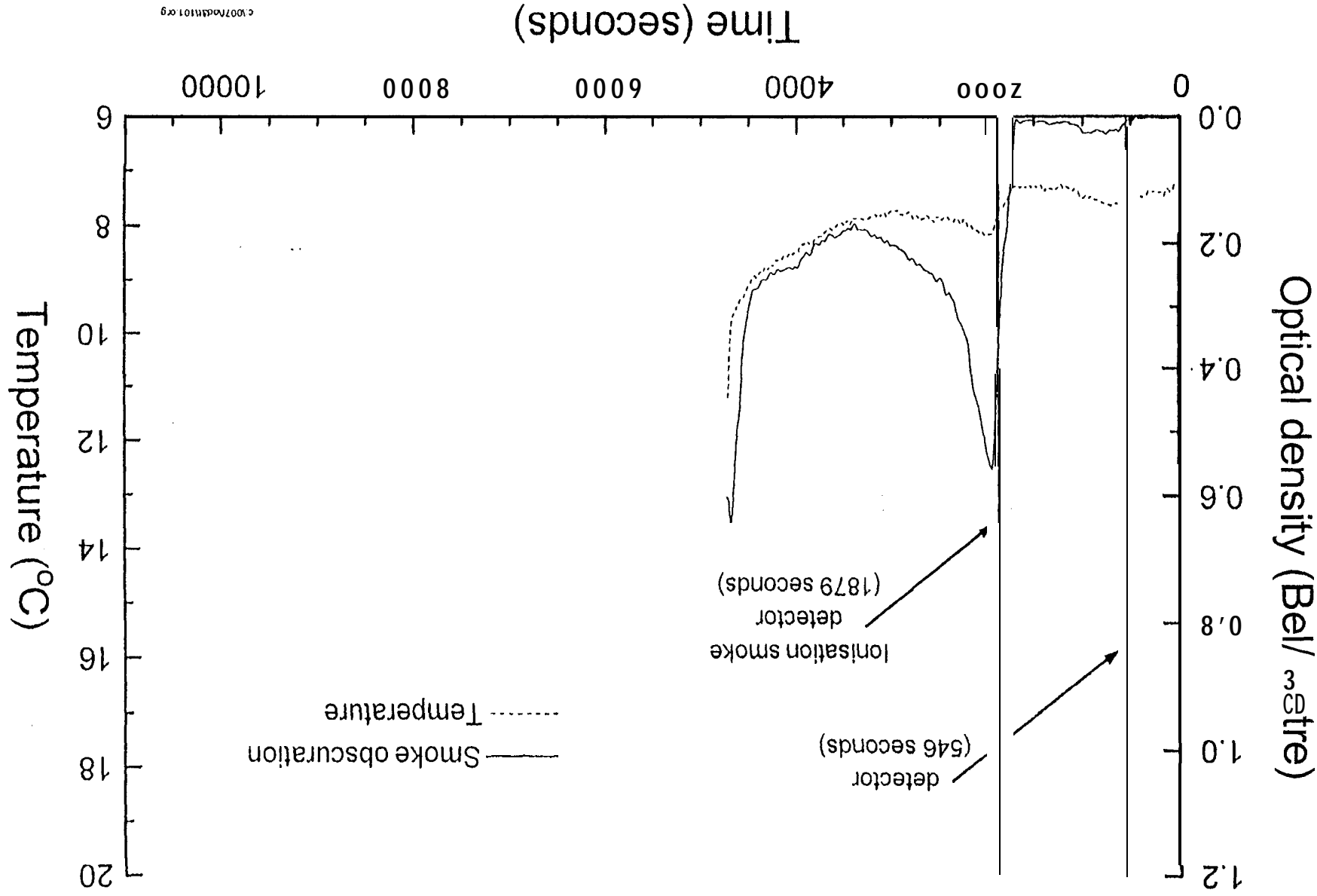

Fig. 6.2.7-4
Smoke obscuration and temperature (smouldering) - Test SM4
 Centre of room 101 ceiling

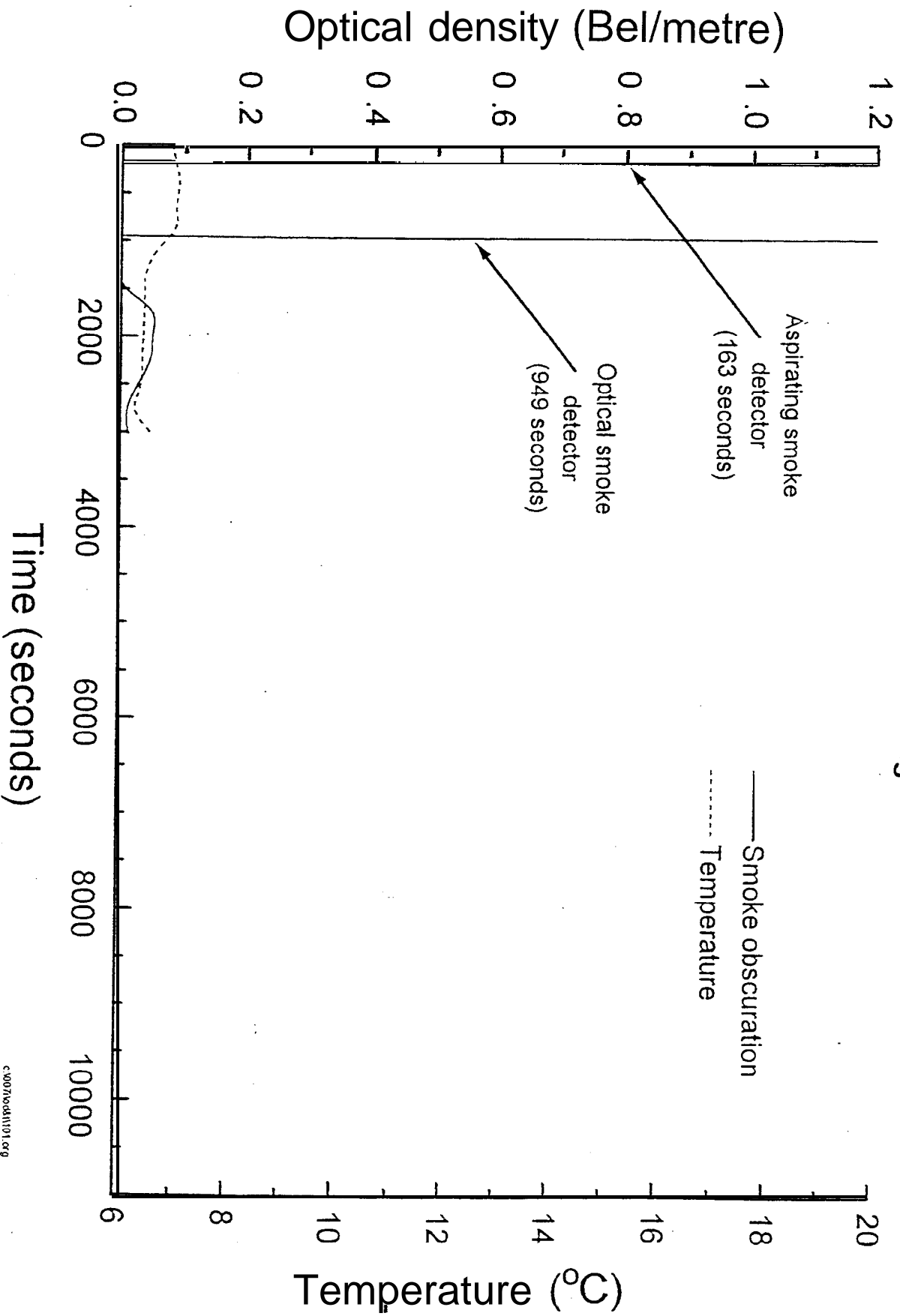

Fig. 6.2.7-5
Smoke obscuration and temperature (smouldering) - Test SM5
 Centre of room 101 ceiling

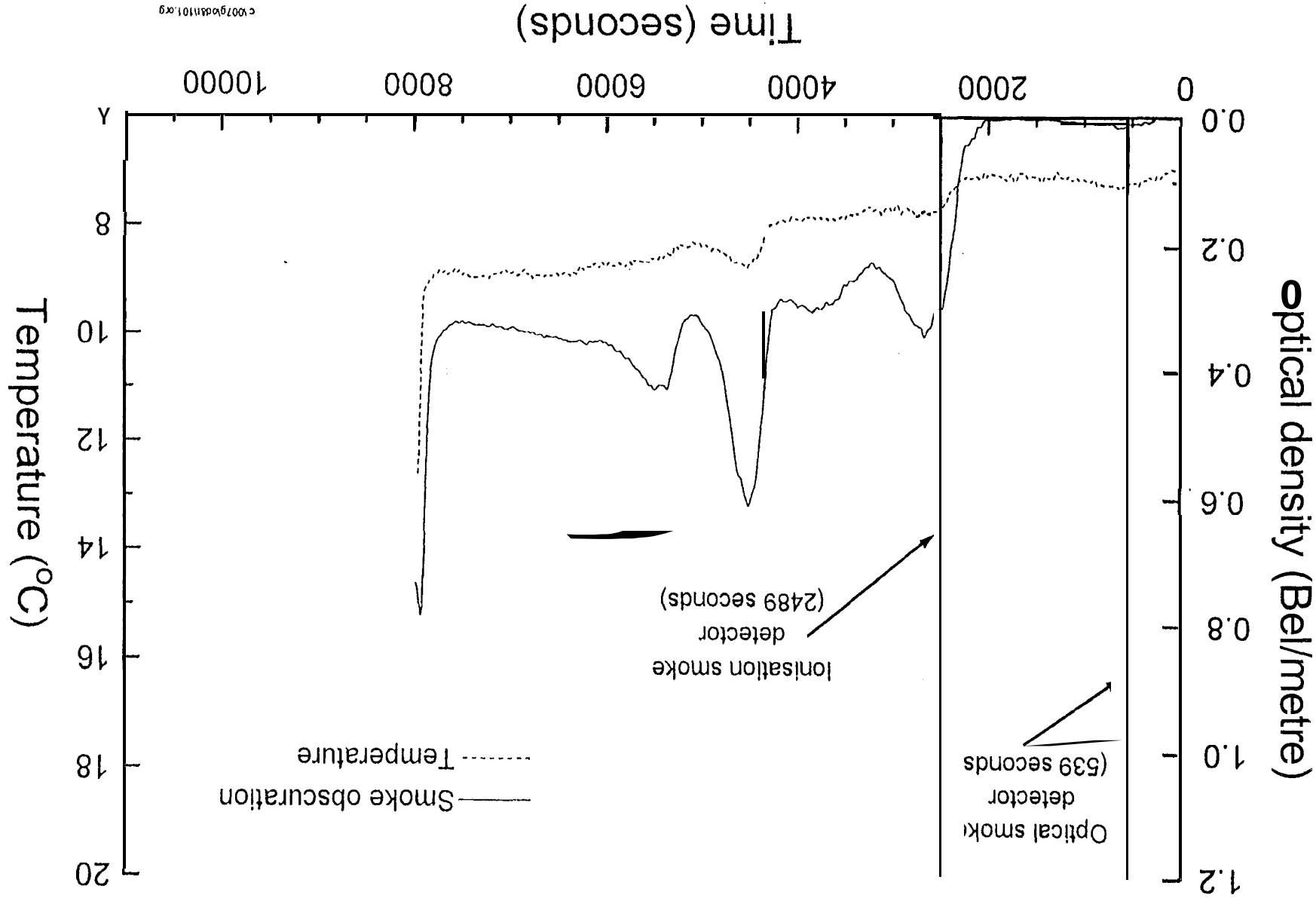

Fig. 6.2.7-6

Smoke obscuration and temperature (smouldering) - Test SM6

Centre of room 101 ceiling

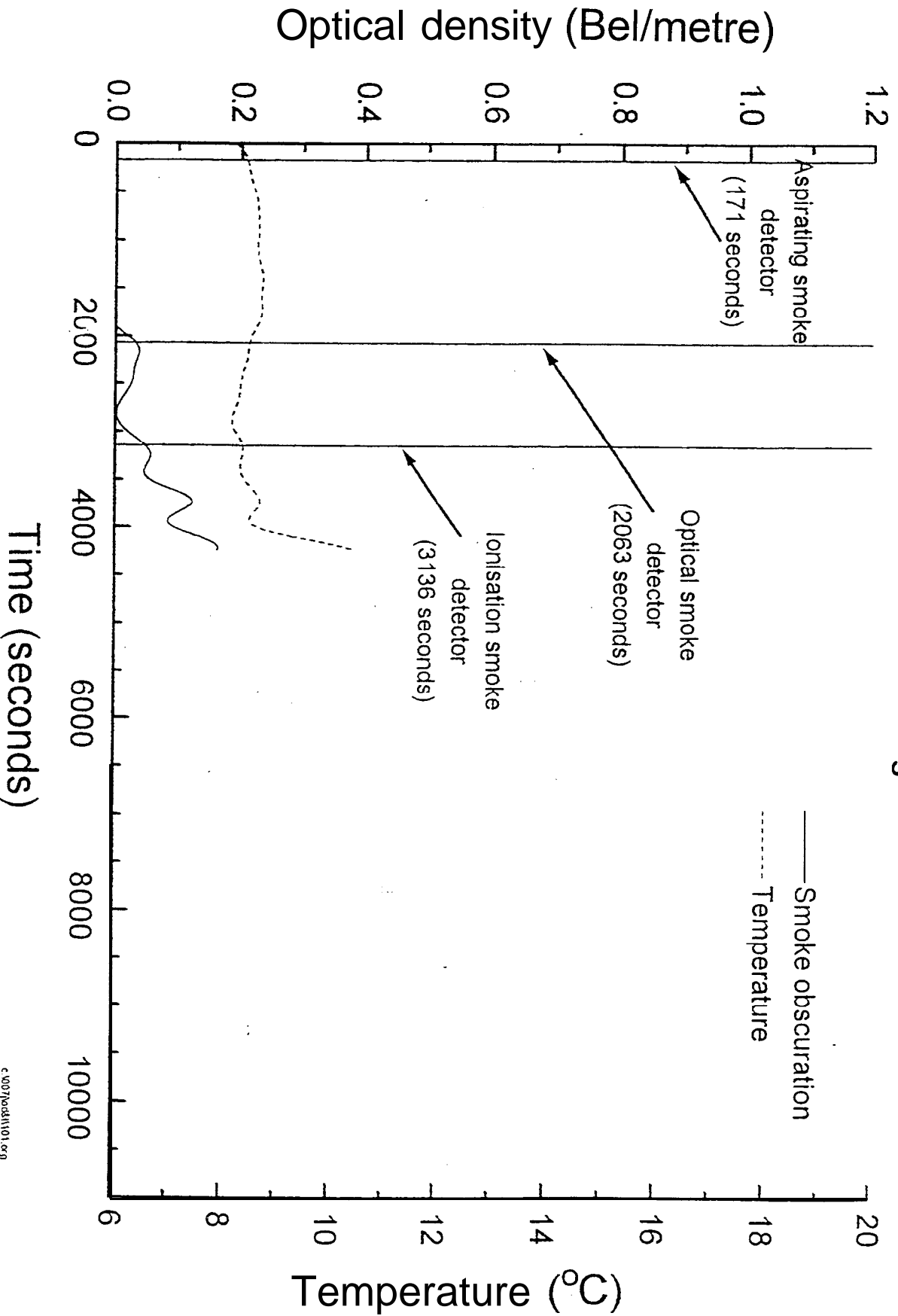

Fig. 6.2.7-7

Smoke obscuration and temperature (smouldering) - Test SM7

Centre of room 101 ceiling

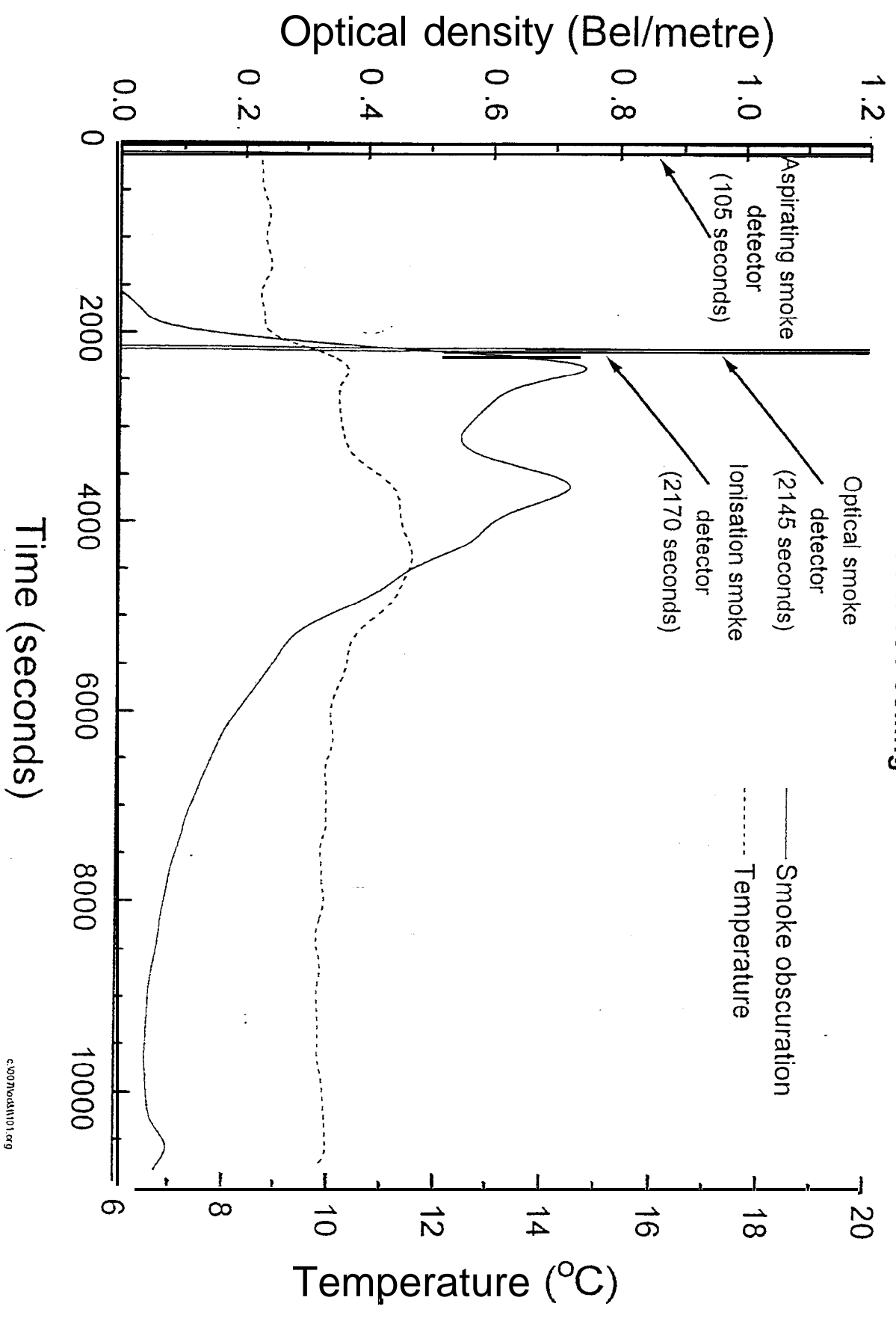

Fig. 6.2.7-8

Smoke obscuration and temperature (smouldering) - Test SM8

Centre of room 101 ceiling

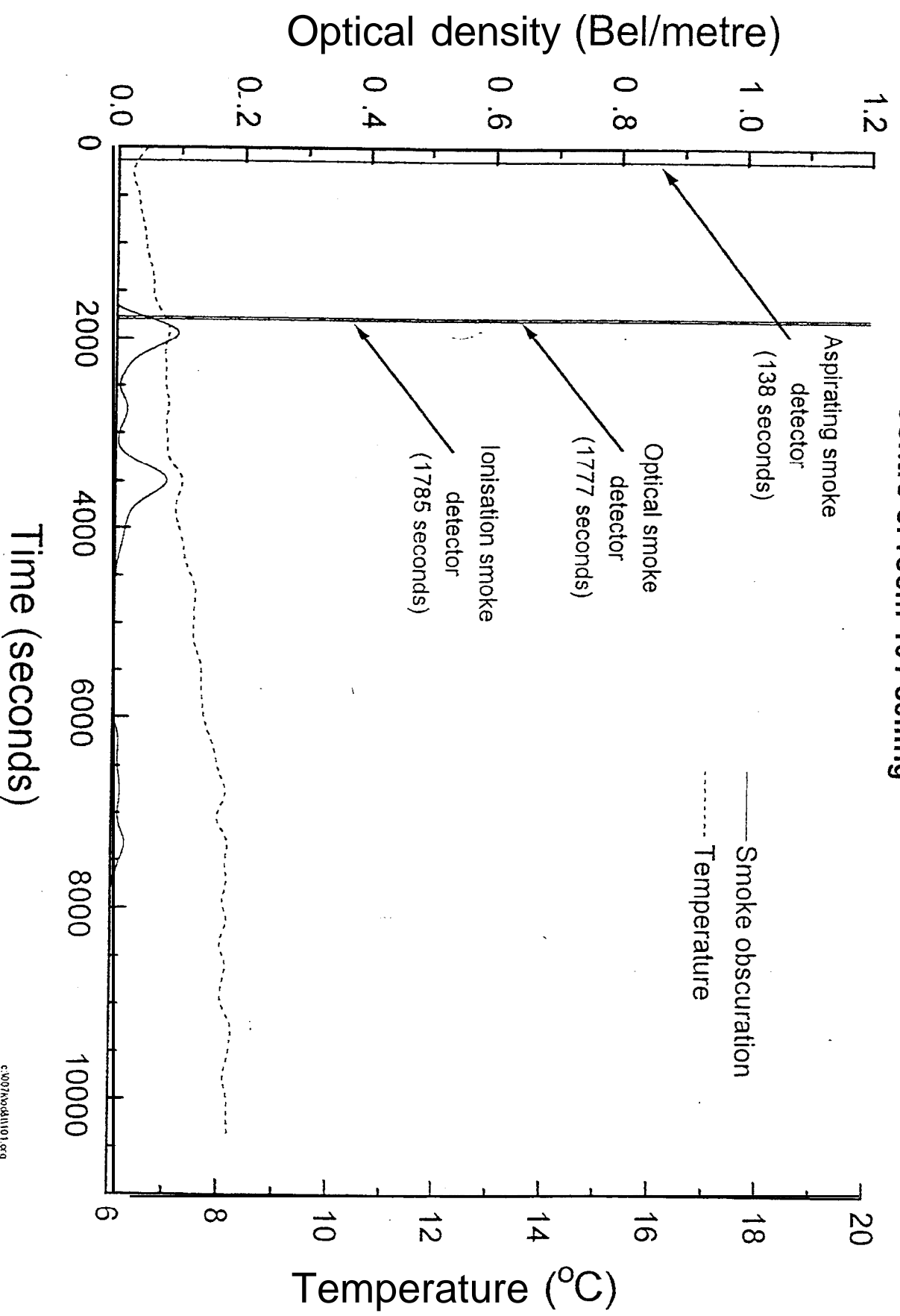
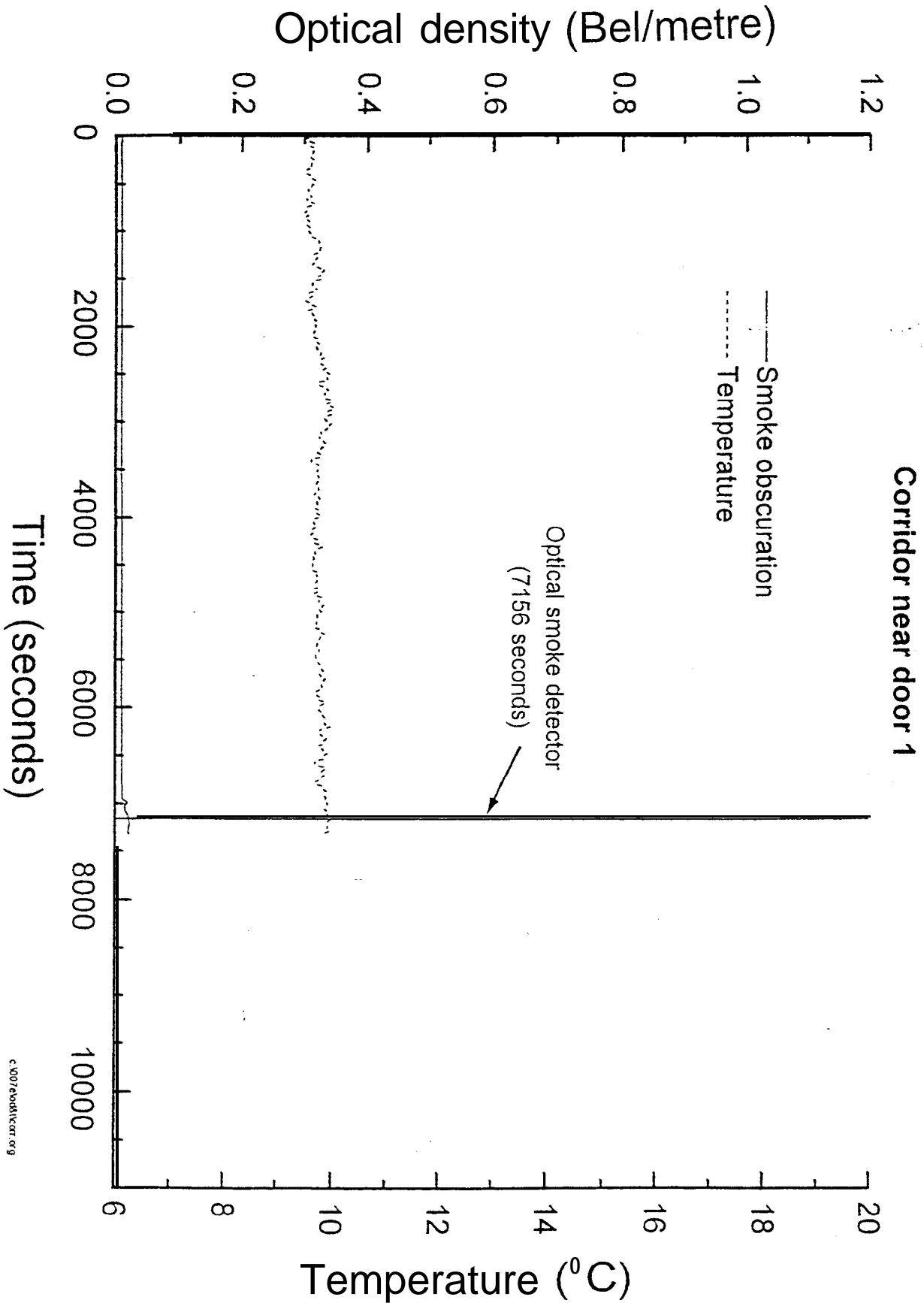

Fig. 6.2.7-9

Smoke obscuration and temperature (smouldering) - Test SM1



0
and temperature (smouldering) - Test SM2
Corridor near door 1

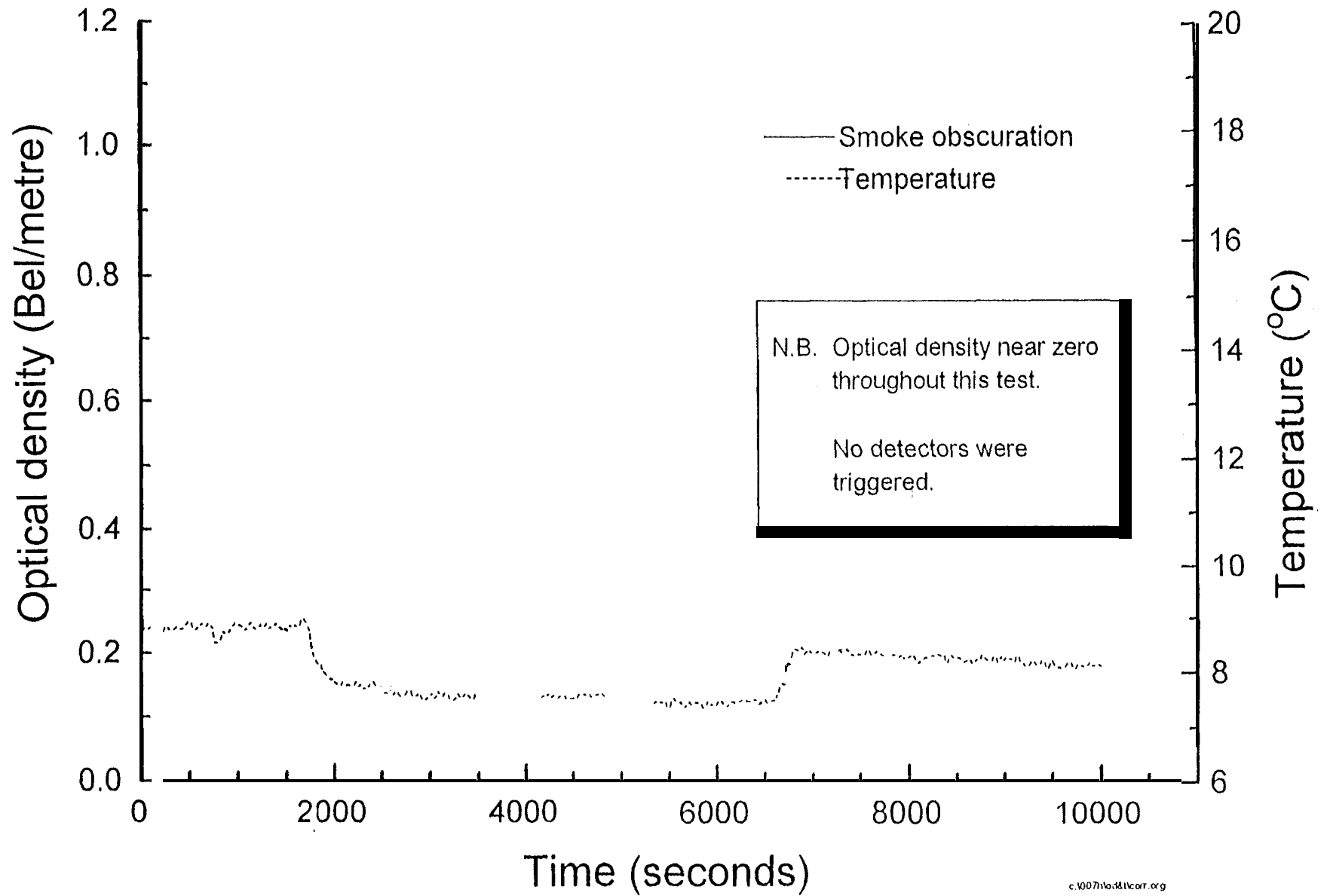

Fig. 6.2.7-11
Smoke obscuration and temperature (smouldering) - Test SM3

Corridor near door 1

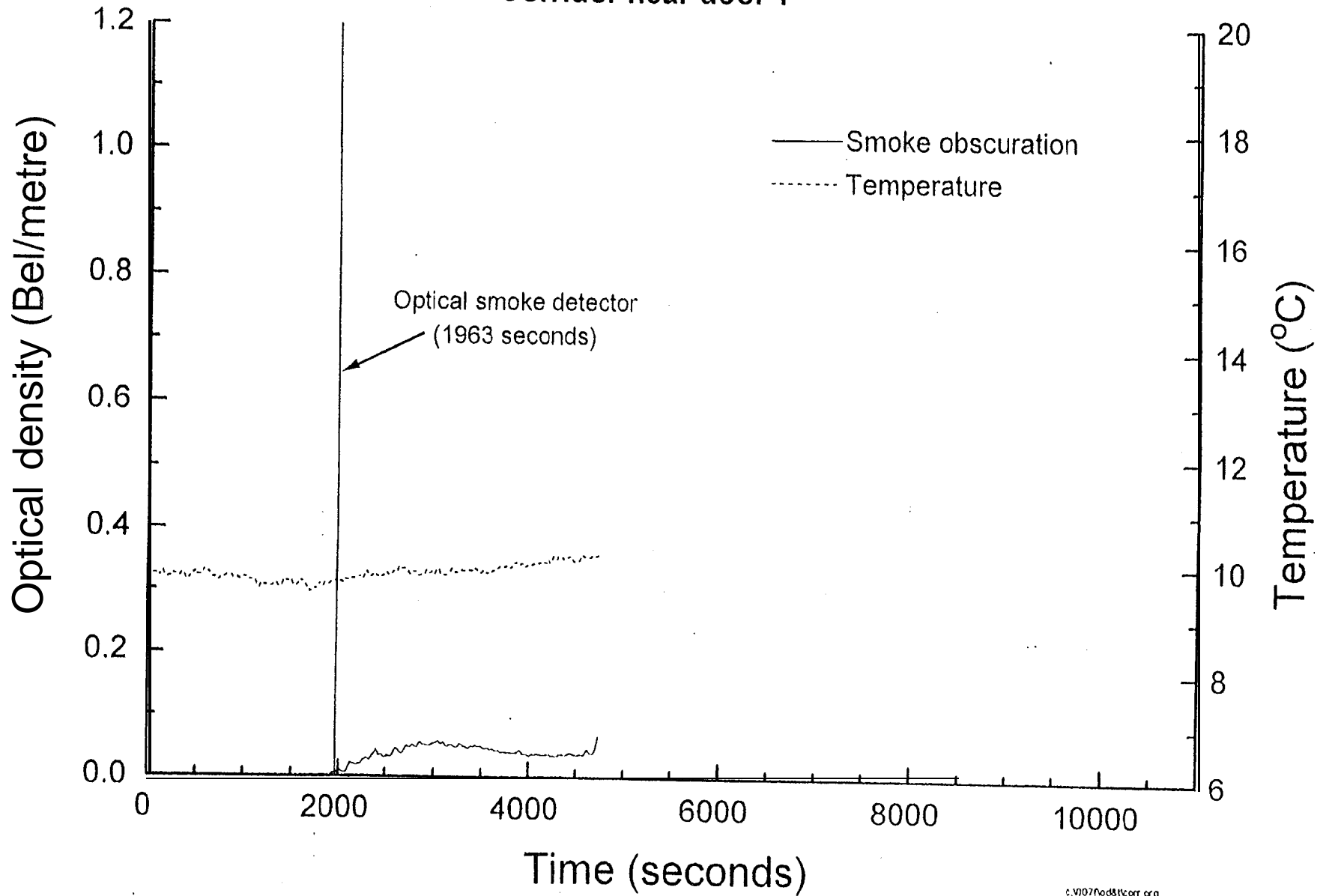

Fig. 6.2.7-12
Smoke obscuration and temperature (smouldering) - Test SM4
Corridor near door 1

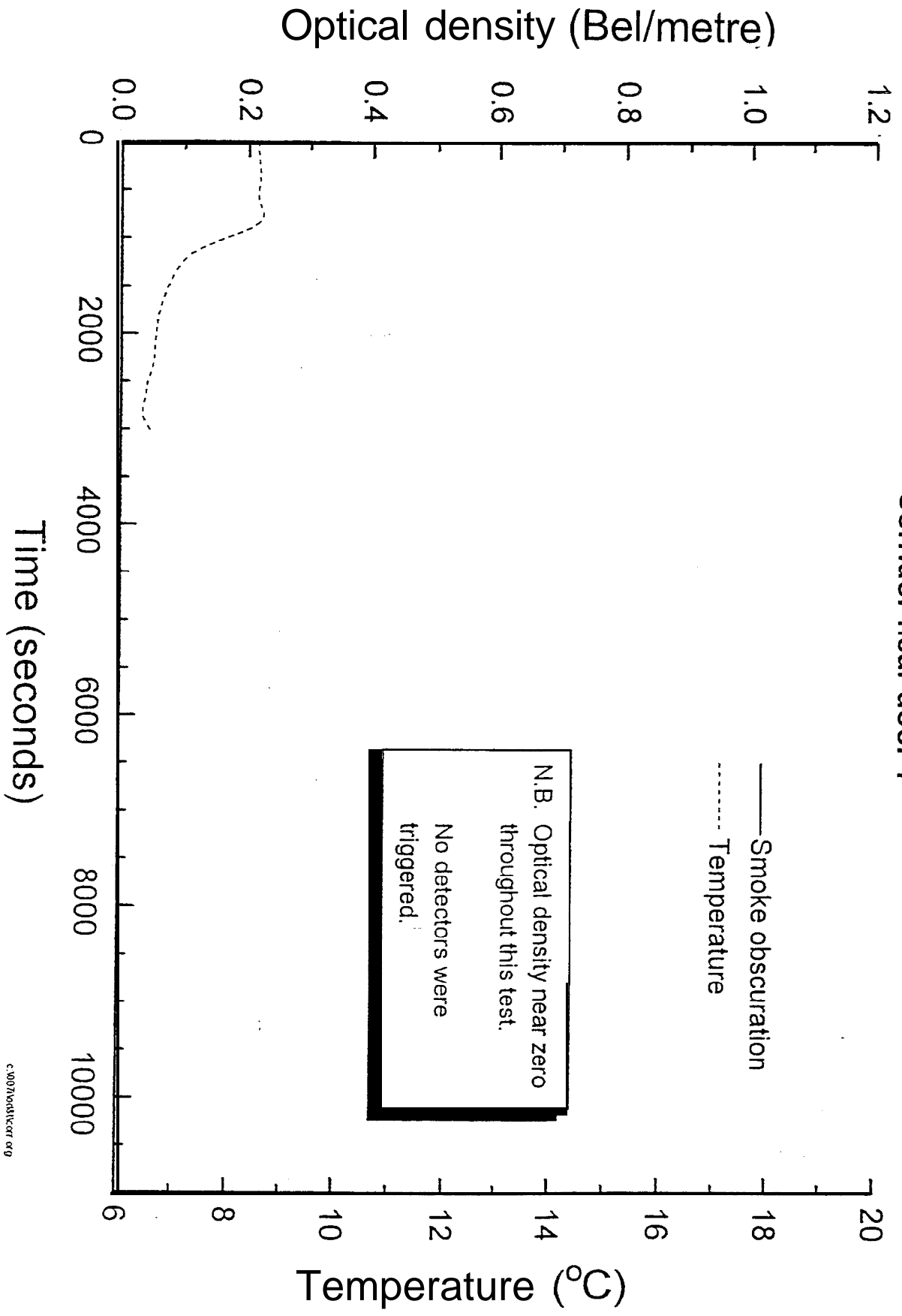
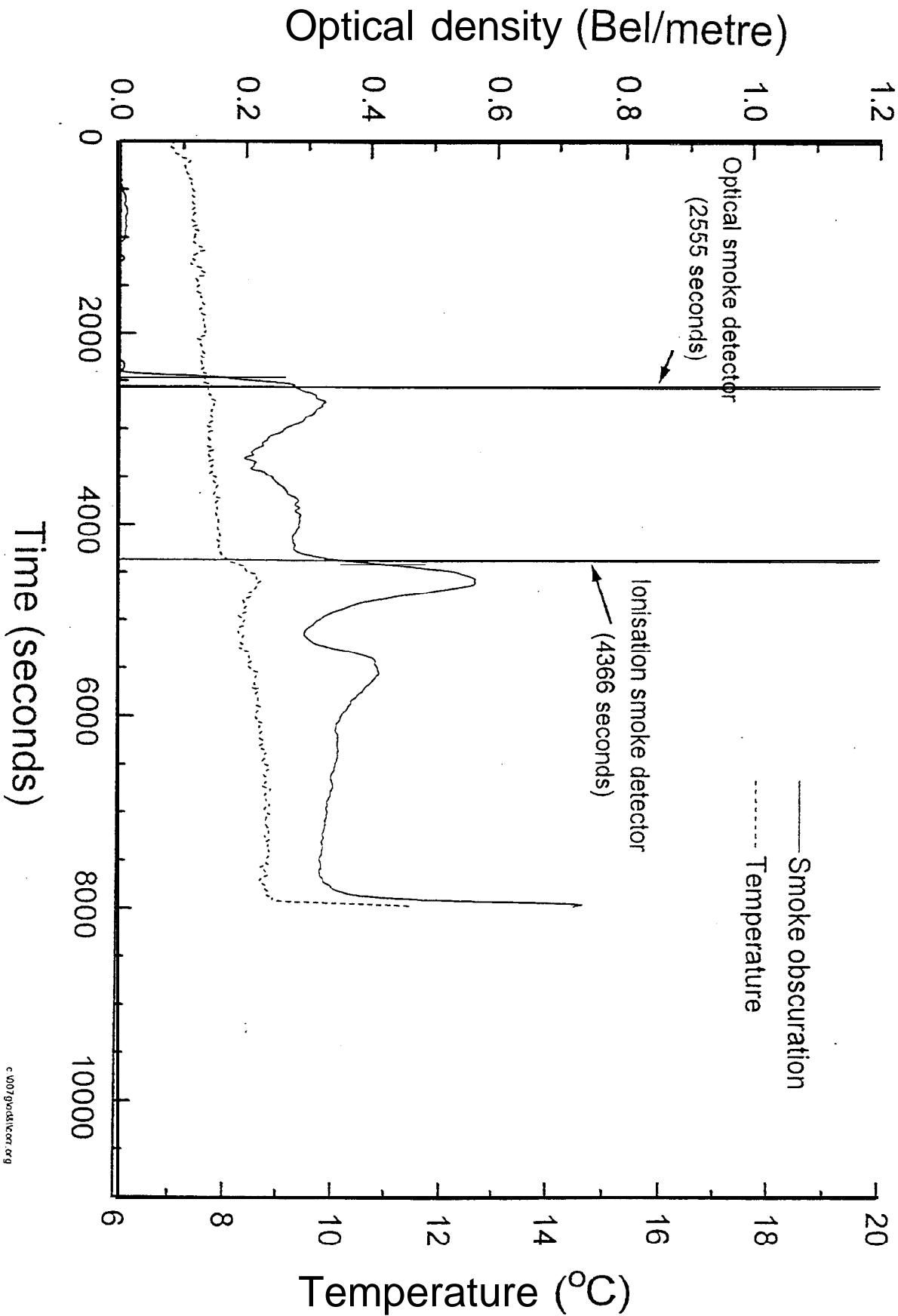

Fig. 6.2.7-13

Smoke obscuration and temperature (smouldering) - Test SM5

Corridor near door 1



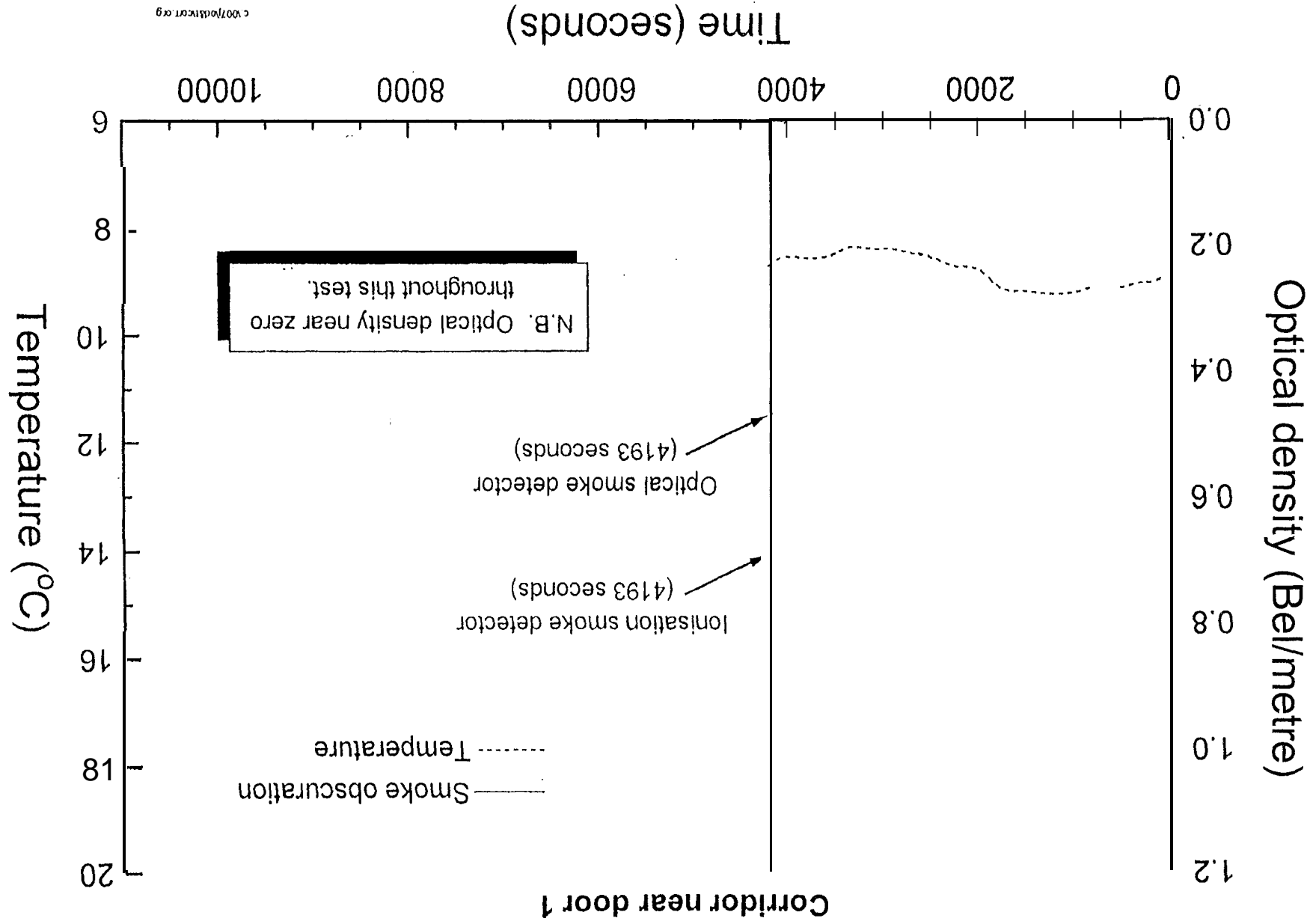

Fig. 6.2.7-1 4

Smoke obscuration end - Test SM6

Corridor near door 1

Fig. 6.2.7-15

Smoke obscuration and temperature (smouldering) - Test SM7

Corridor near door 1

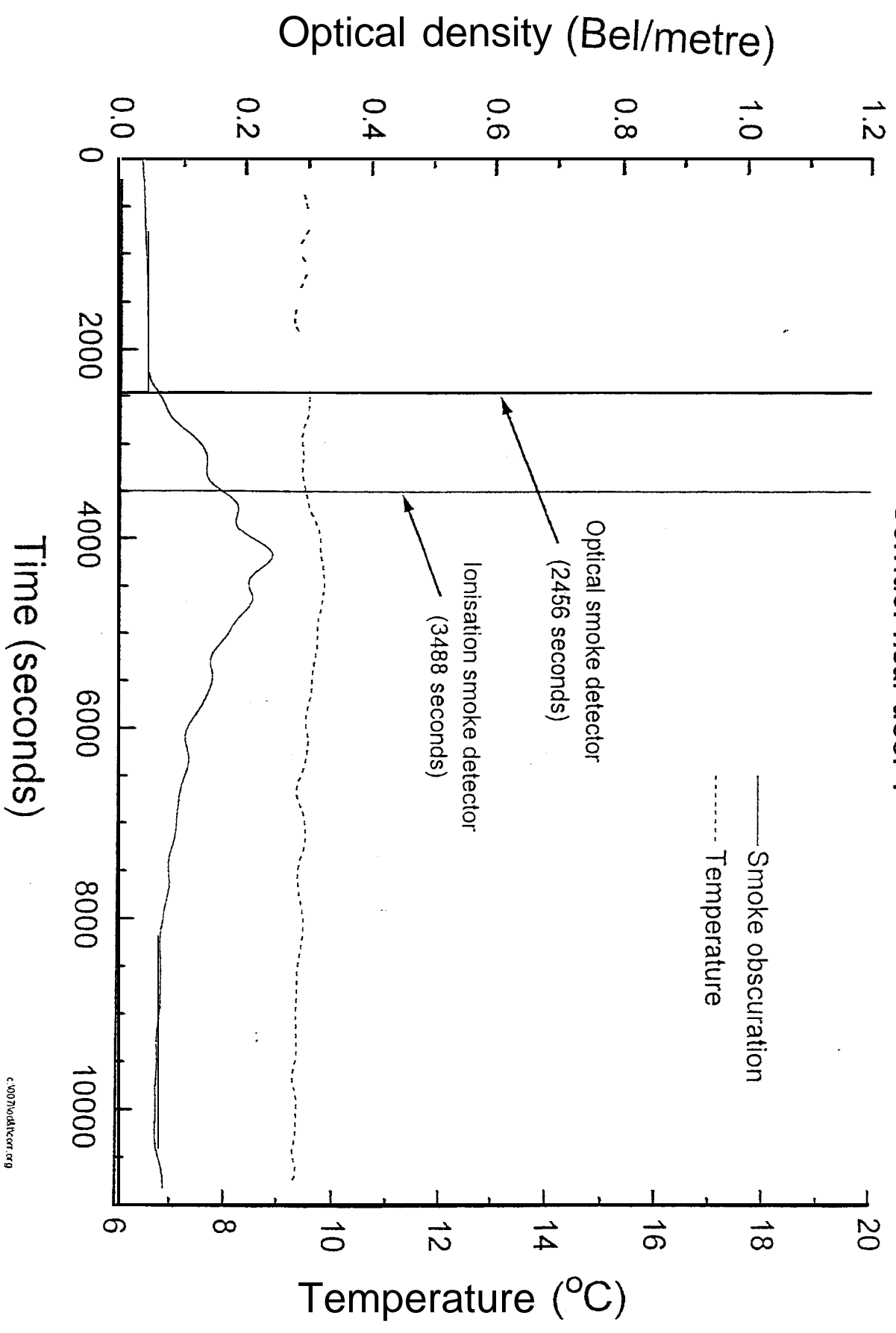
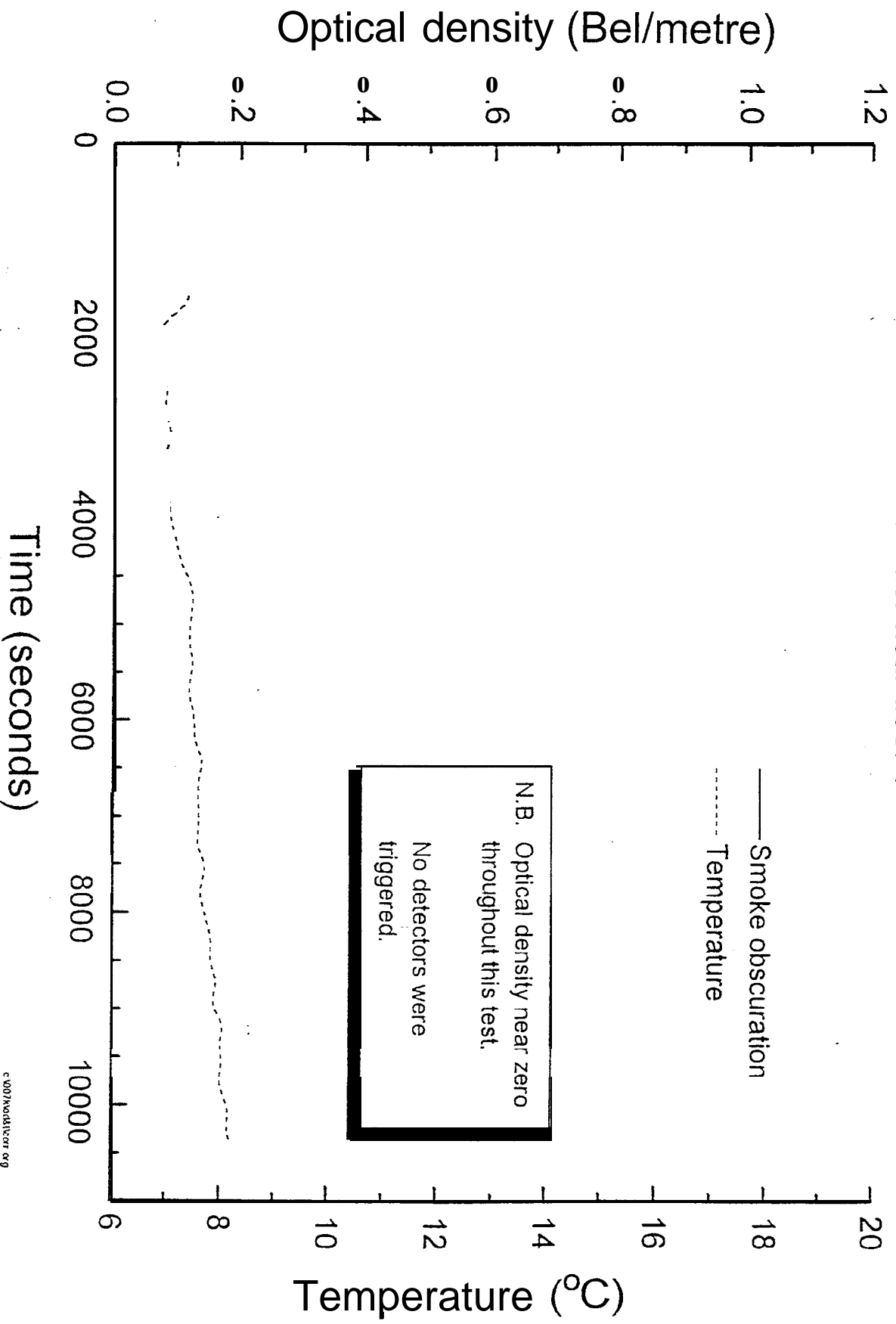

Fig. 6.2.7-16
Smoke obscuration and temperature (smouldering) - Test SM8
Corridor near door 1



- Test SM2

Fig. 6.2.7-17

Smoke obscuration end

Air handling return duct

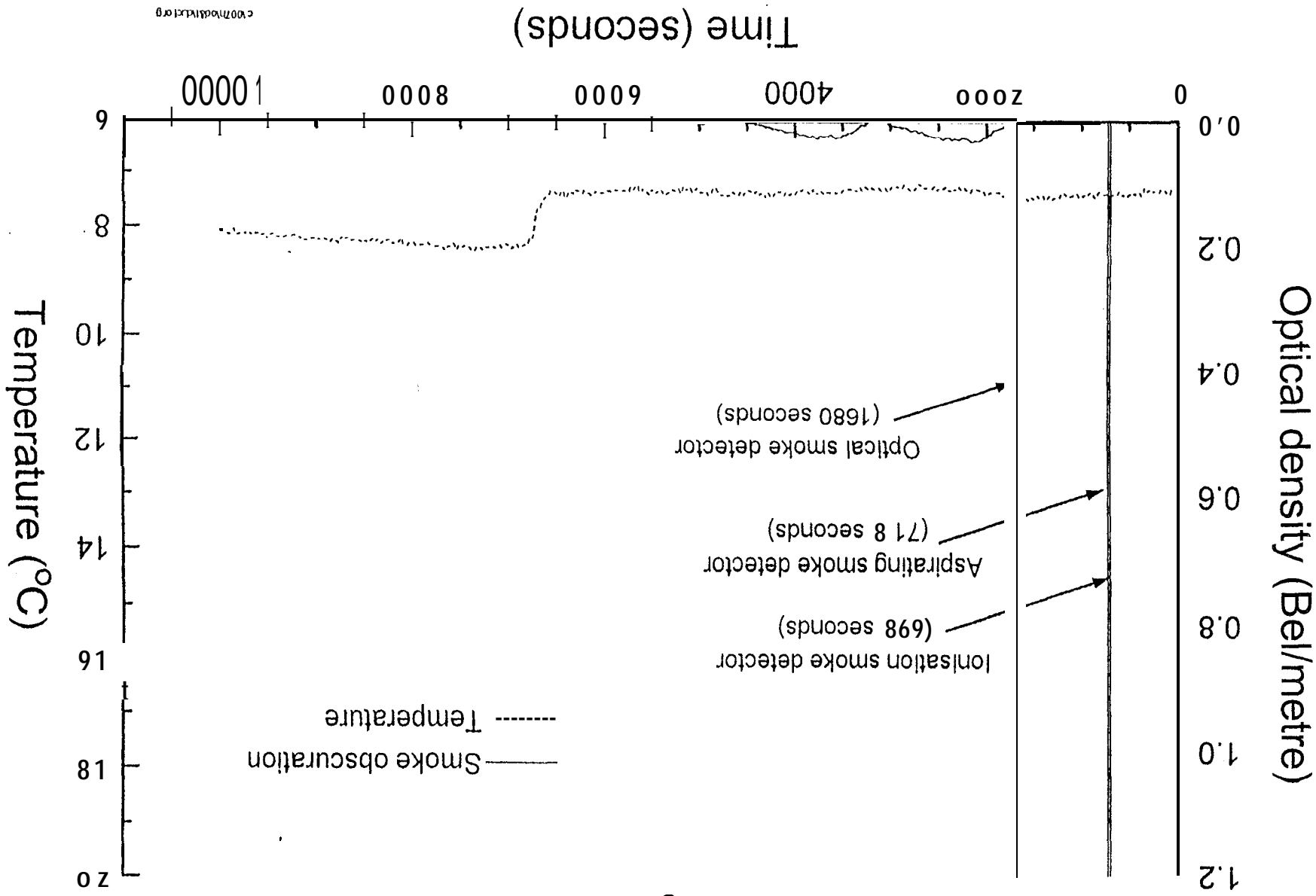

Fig. 6.2.7-18
Smoke obscuration and temperature (smouldering) - Test SM4
Air handling return duct

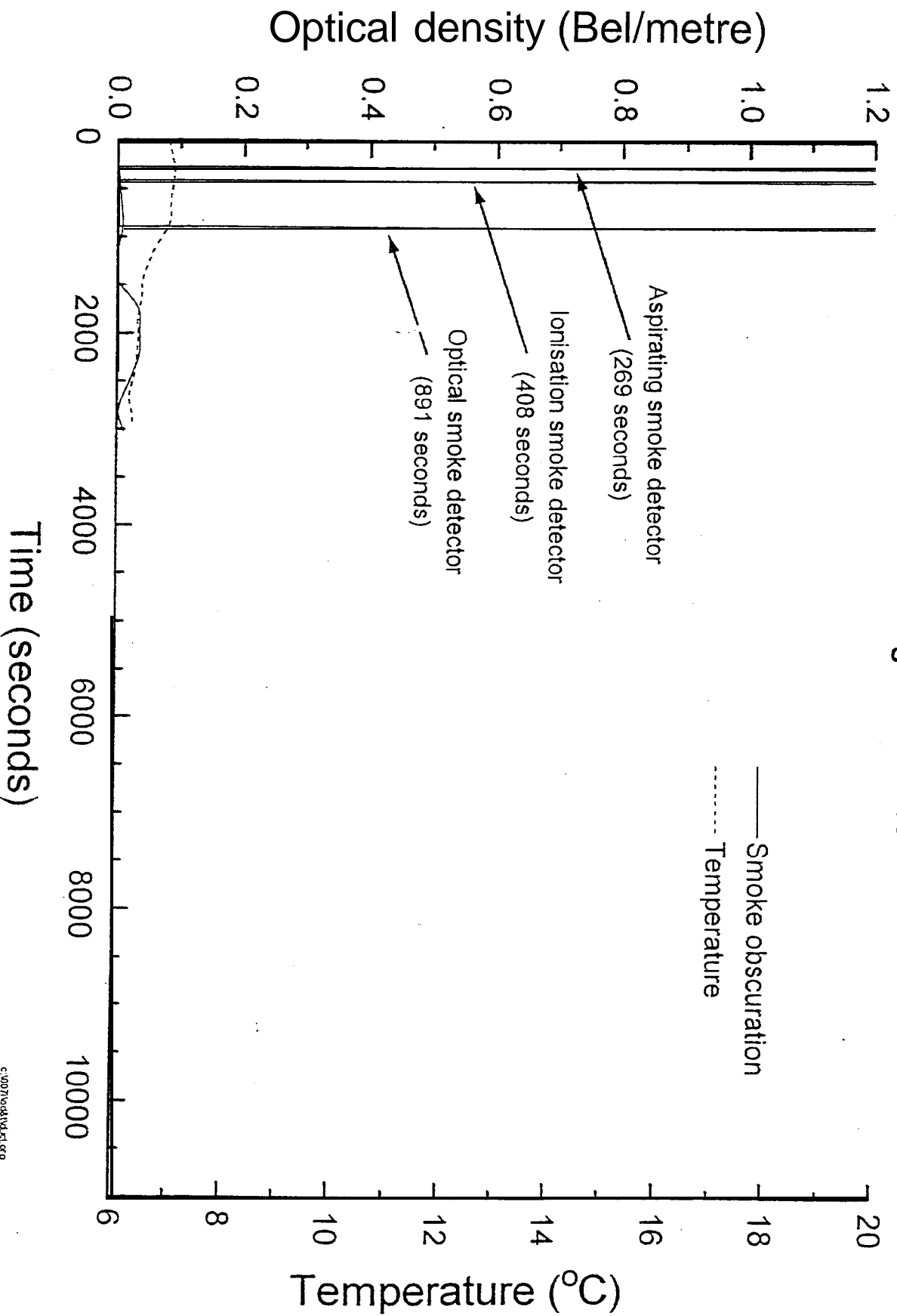

Fig. 6.2.7-19

Smoke obscuration and temperature (smouldering) - Test SM6

Air handling return duct

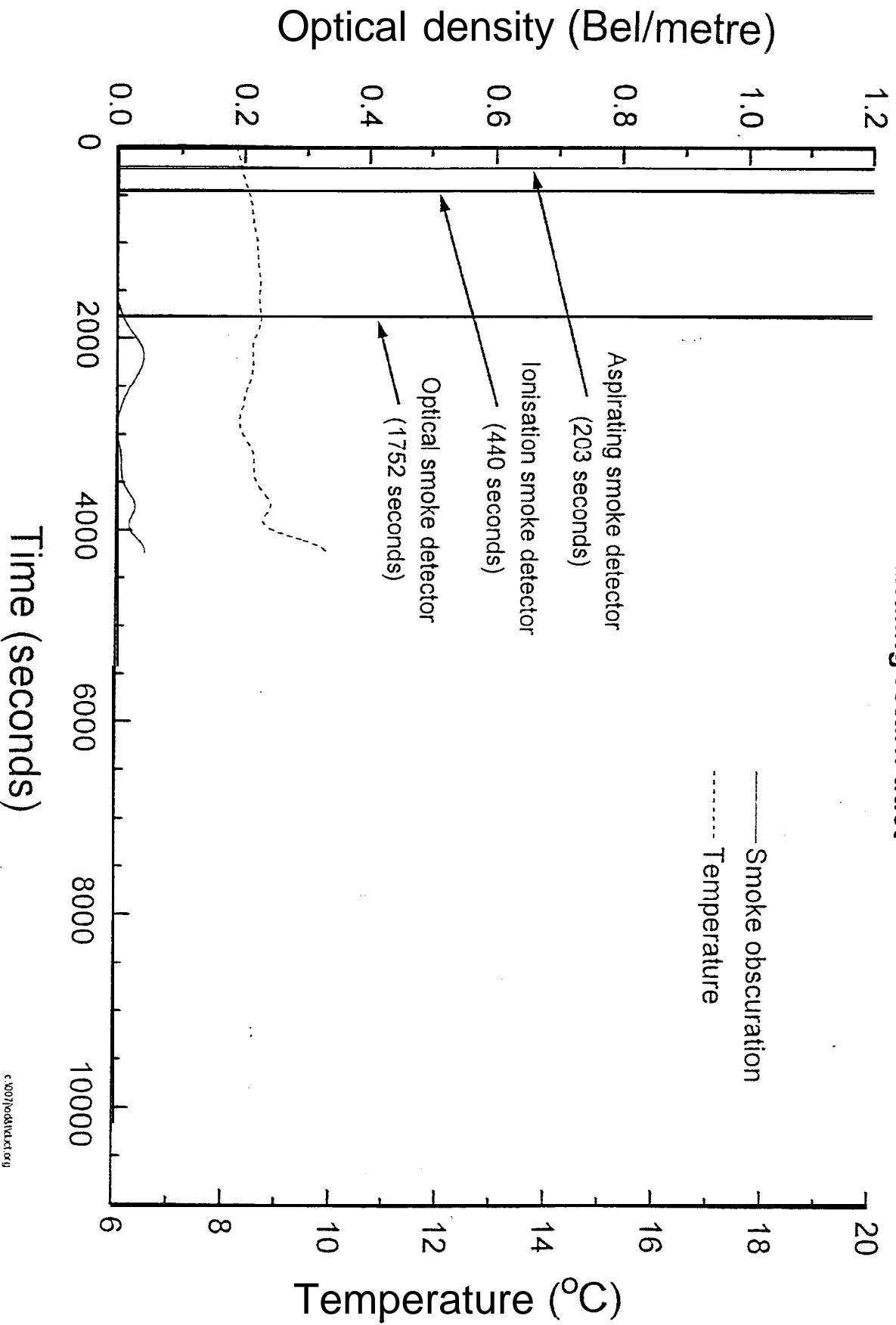

Fig. 6.2.7-20

Smoke obscuration and temperature (smouldering) - Test SM8

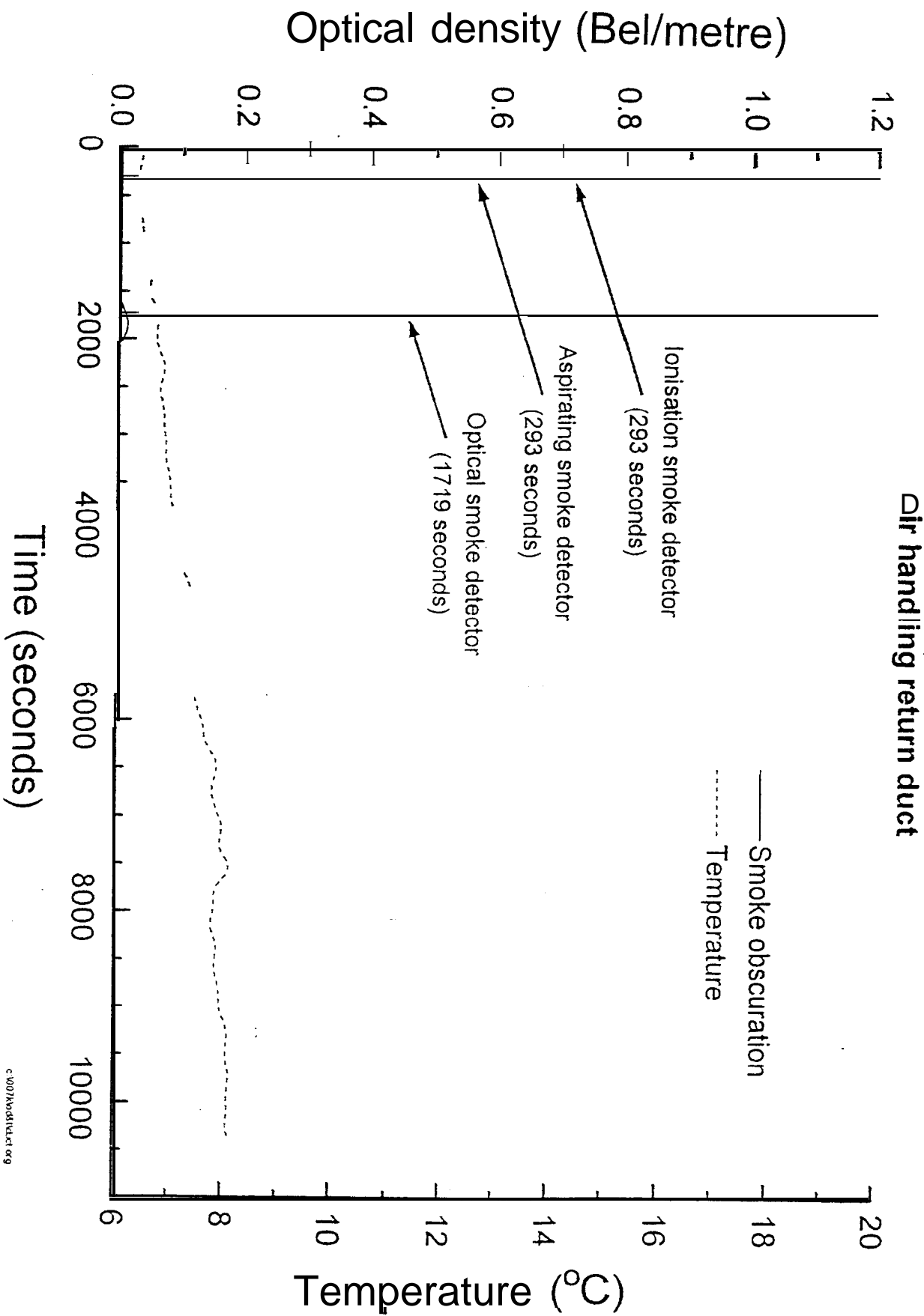
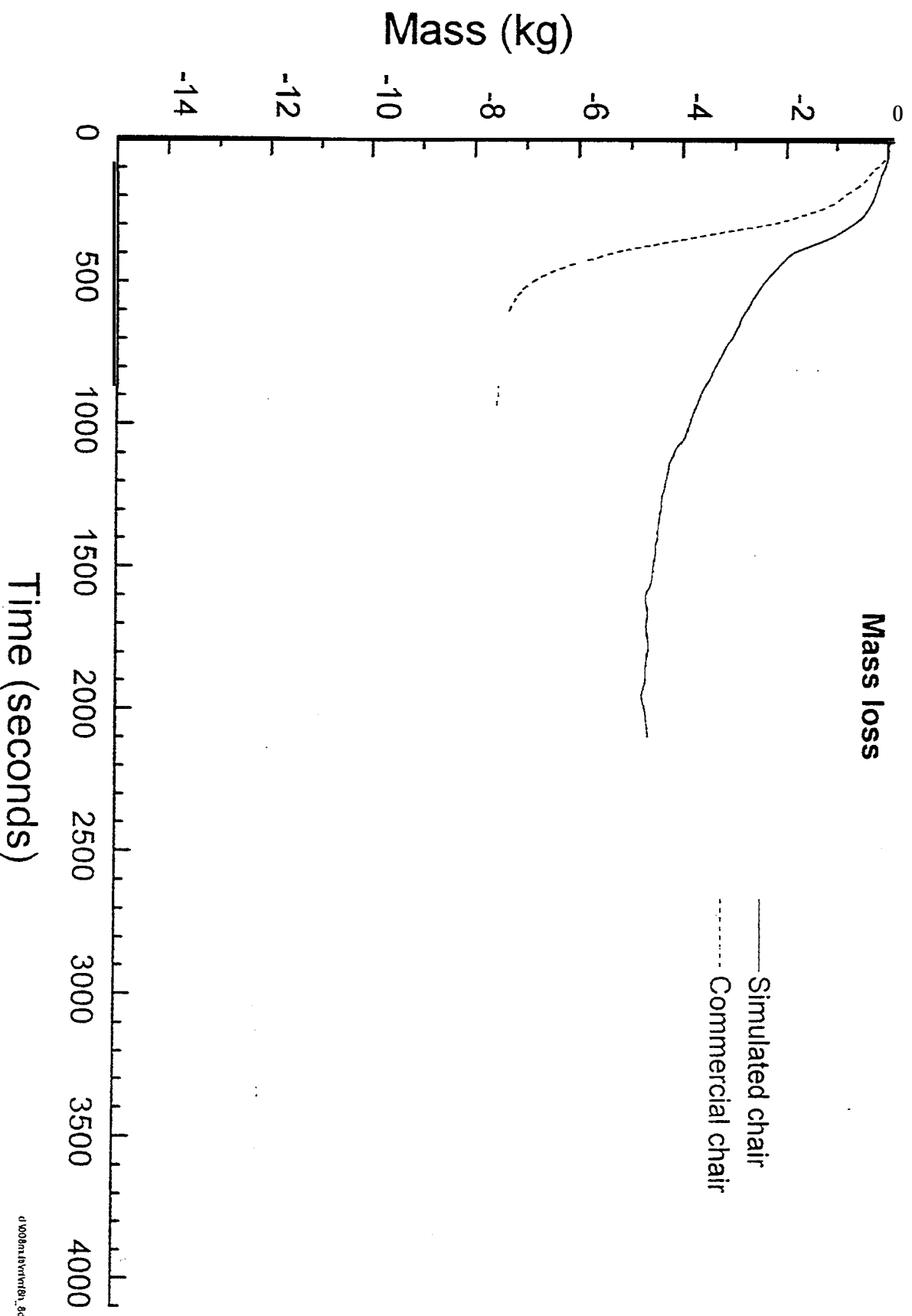

Fig. 7.1.1-1

Commercial product tests (Flaming fire in small room)



Commercial product tests (Flaming fire in small room)

Fig. 7.1.2-1

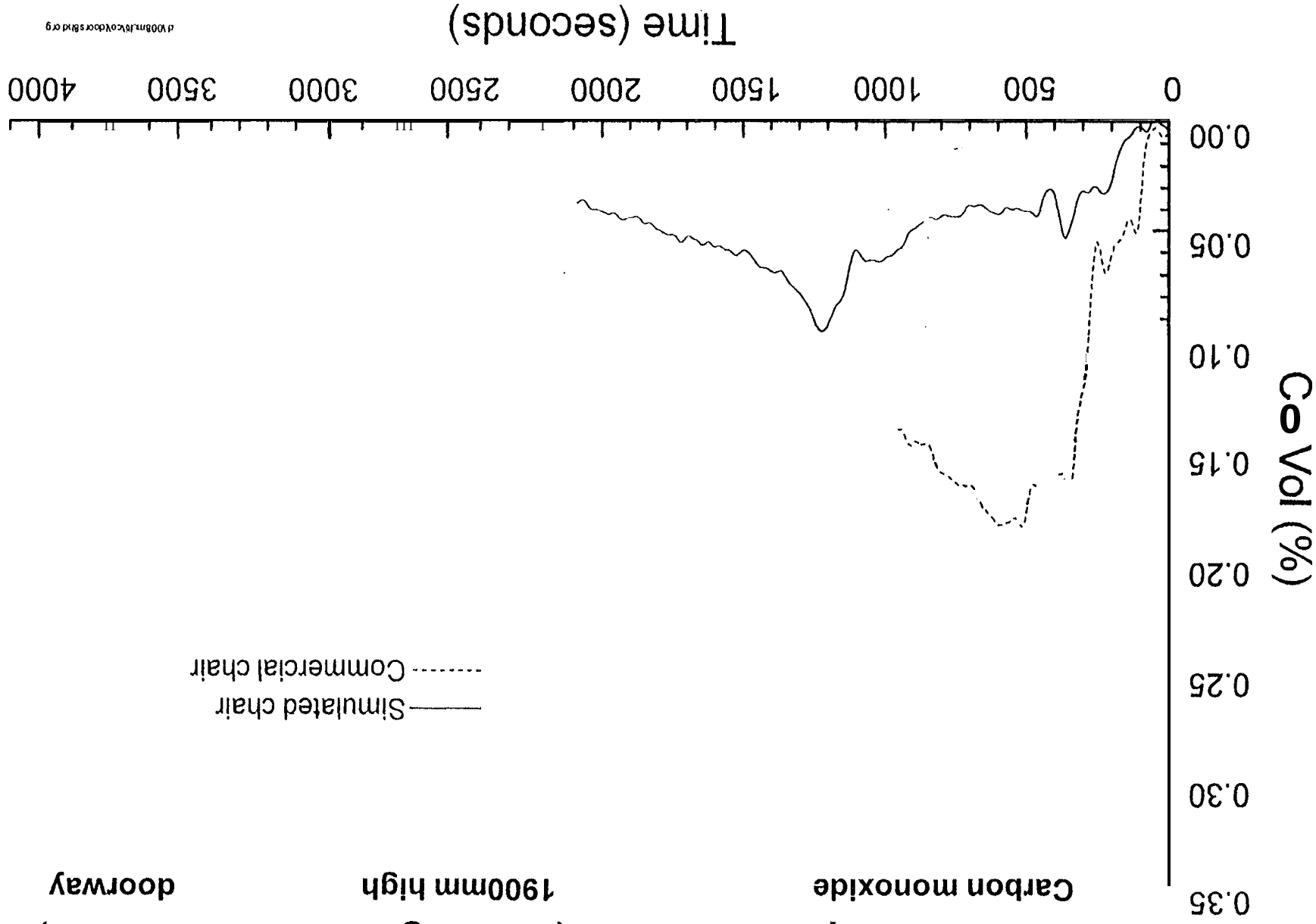

Fig. 7.1.3-1

Commercial product tests (Flaming fire in small room)

Oxygen concentration at 2000mm high in room 102 doorway

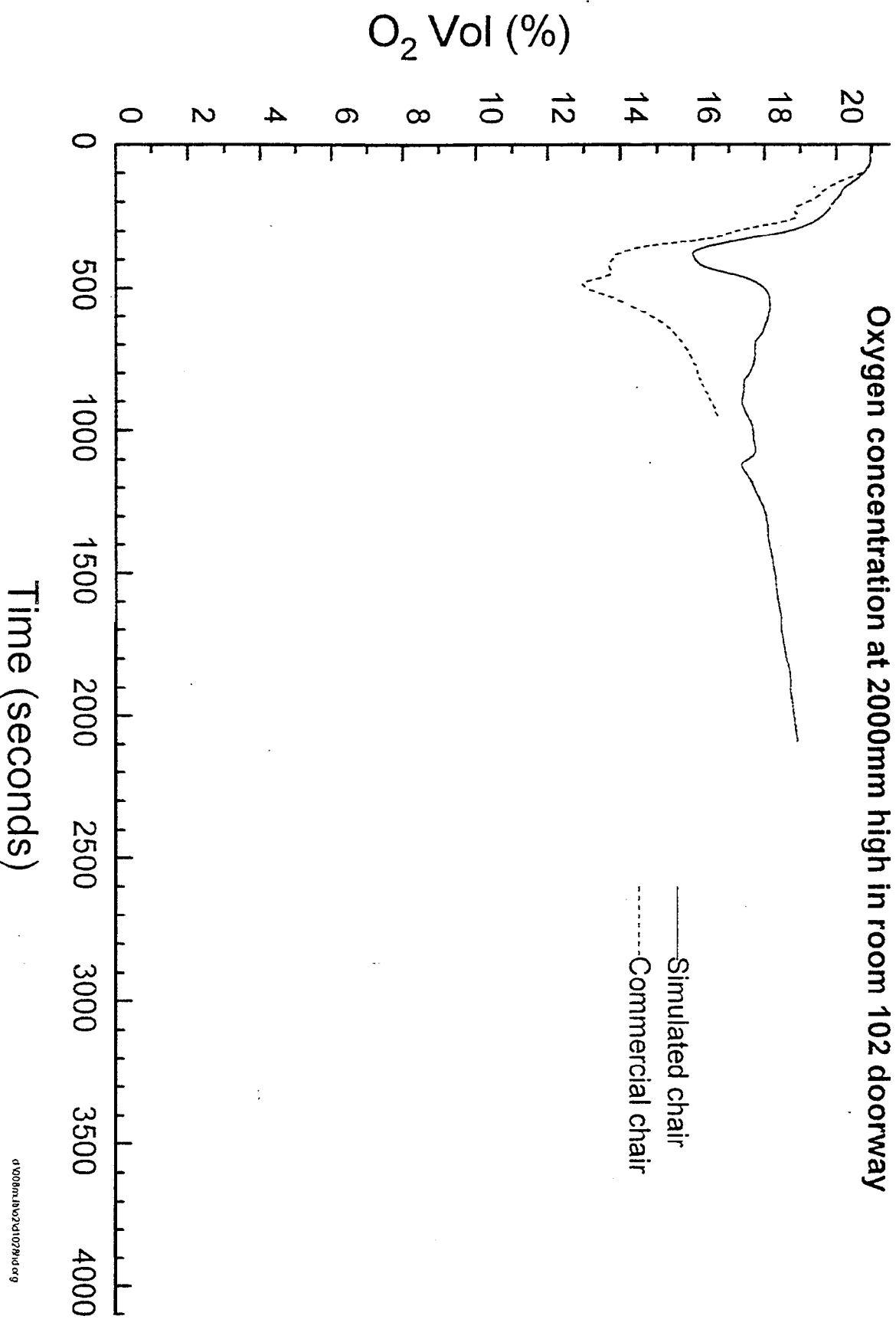

Fig. 7.1.4-1

Commercial product tests (Flaming fire in small room)

Average temperature in room 102

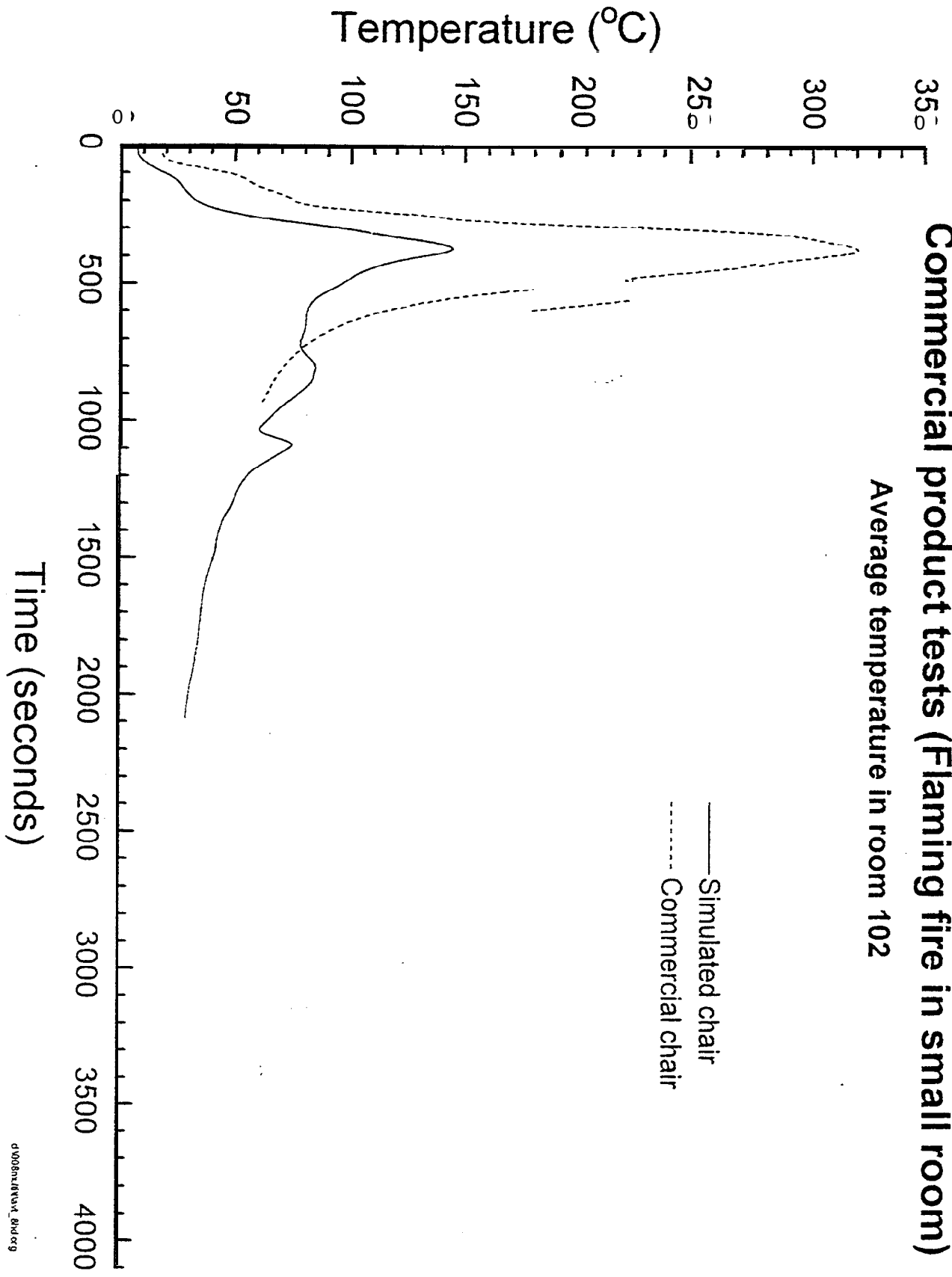

Fig. 7.2.1-1
Mass loss (Flaming fire in small room) - Test FMS1

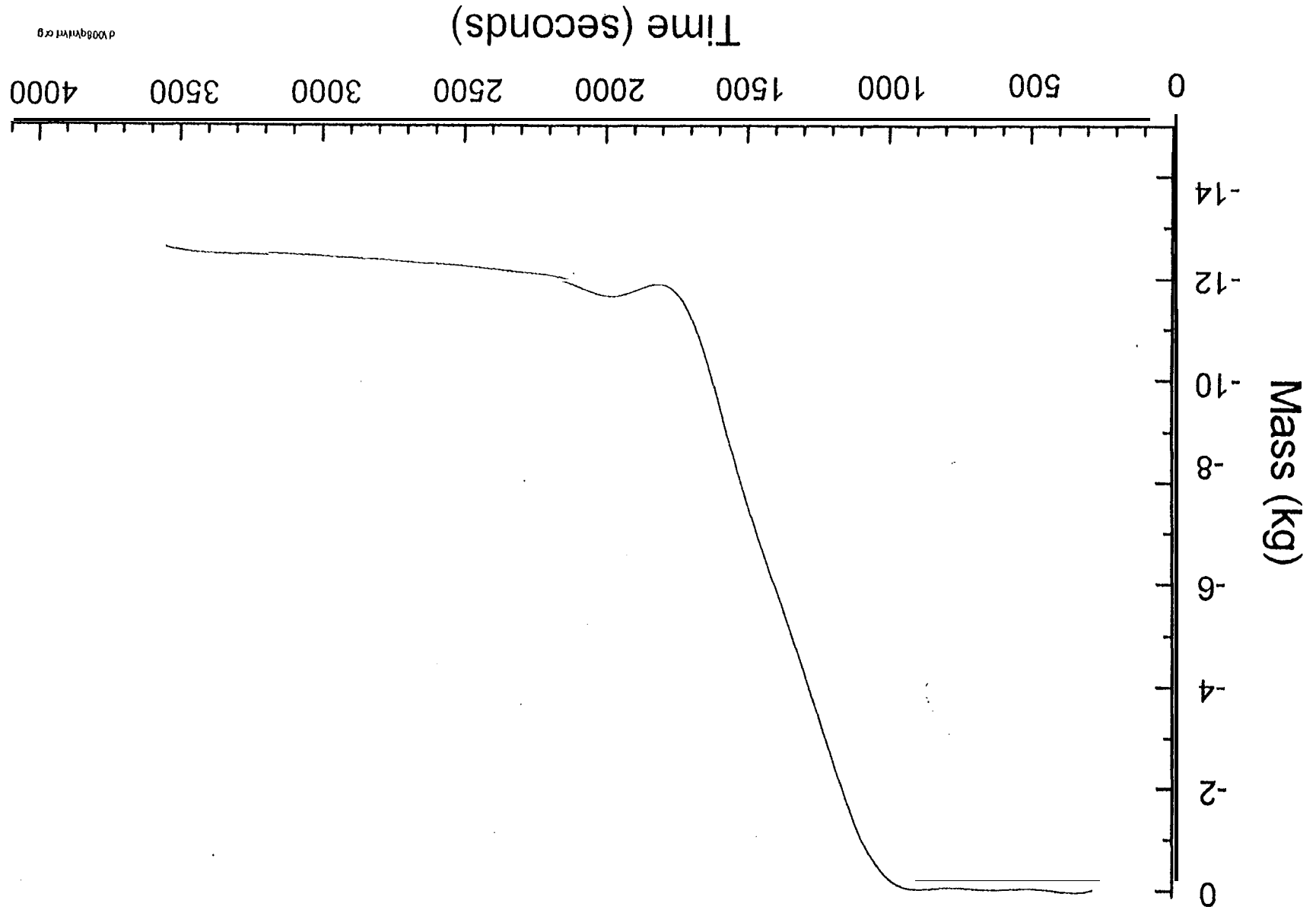

Fig. 7.2.1-2

Mass loss (Flaming fire in small room) - Test FMS2

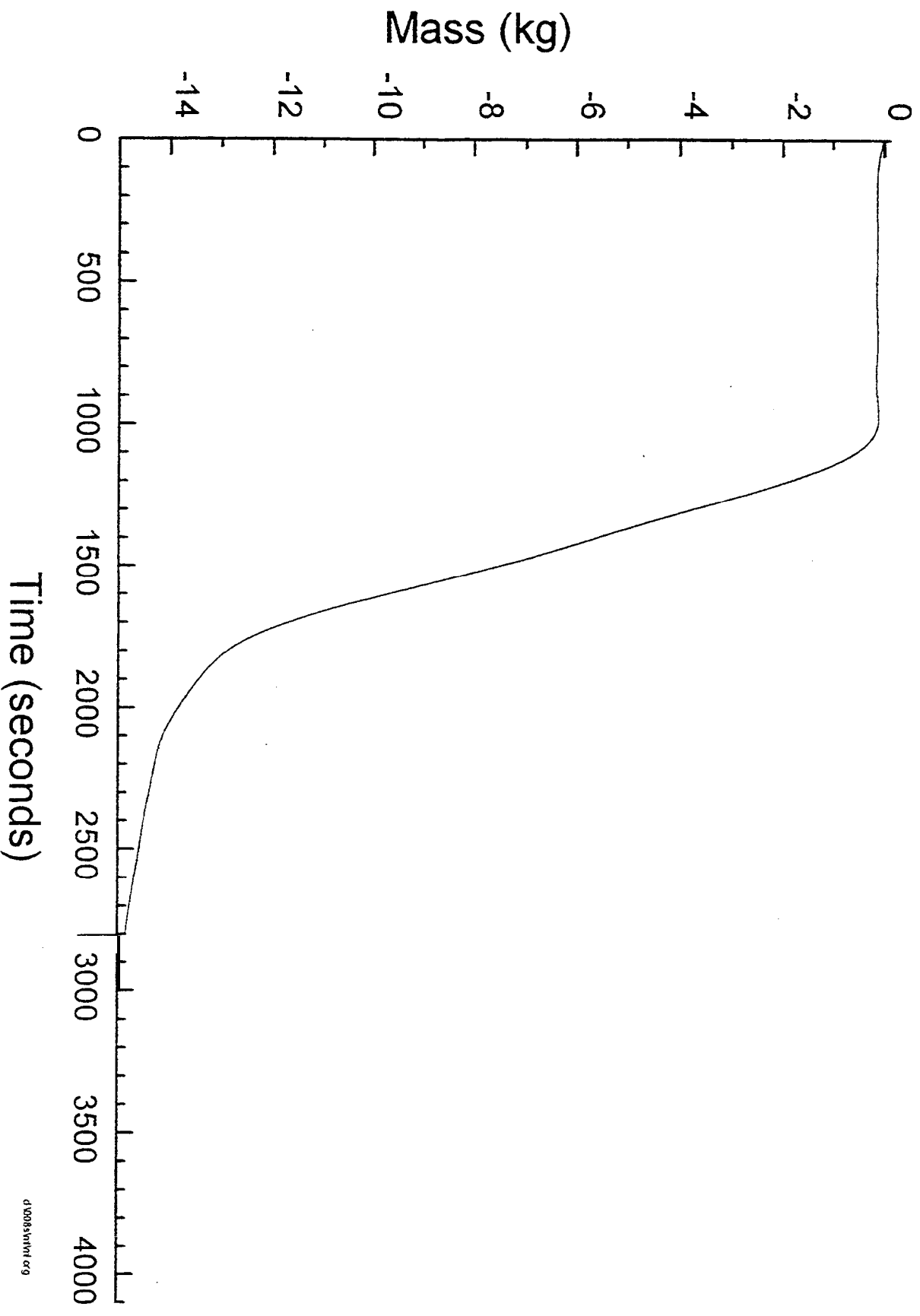
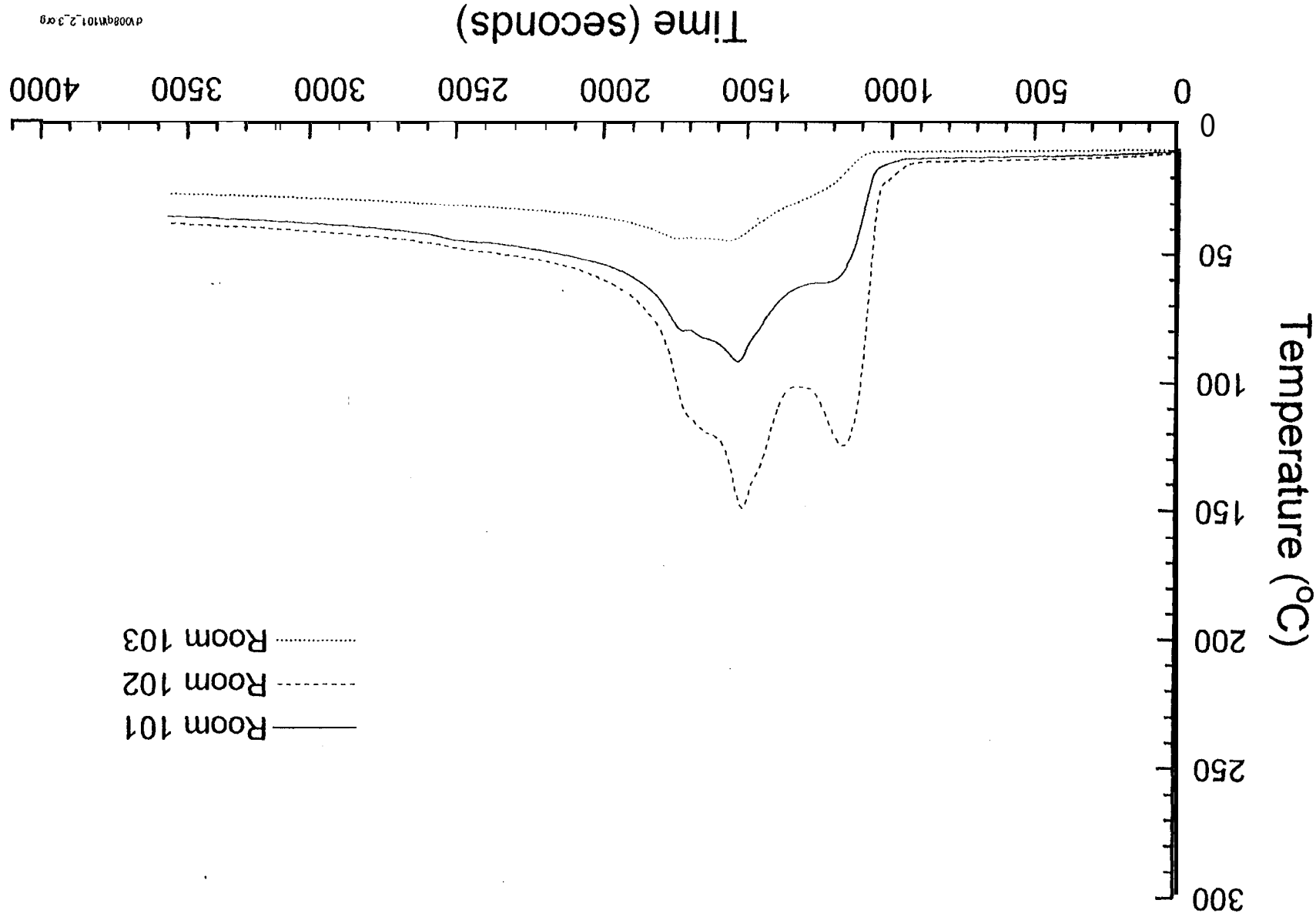

Fig. 7.2.2-1
Average room temperatures (Flaming fire in small room) - Test FMS1



P:\088M101_2_3.xls

Fig. 7.2.2-2 Average room temperatures (Flaming fire in small room) - Test FMS2

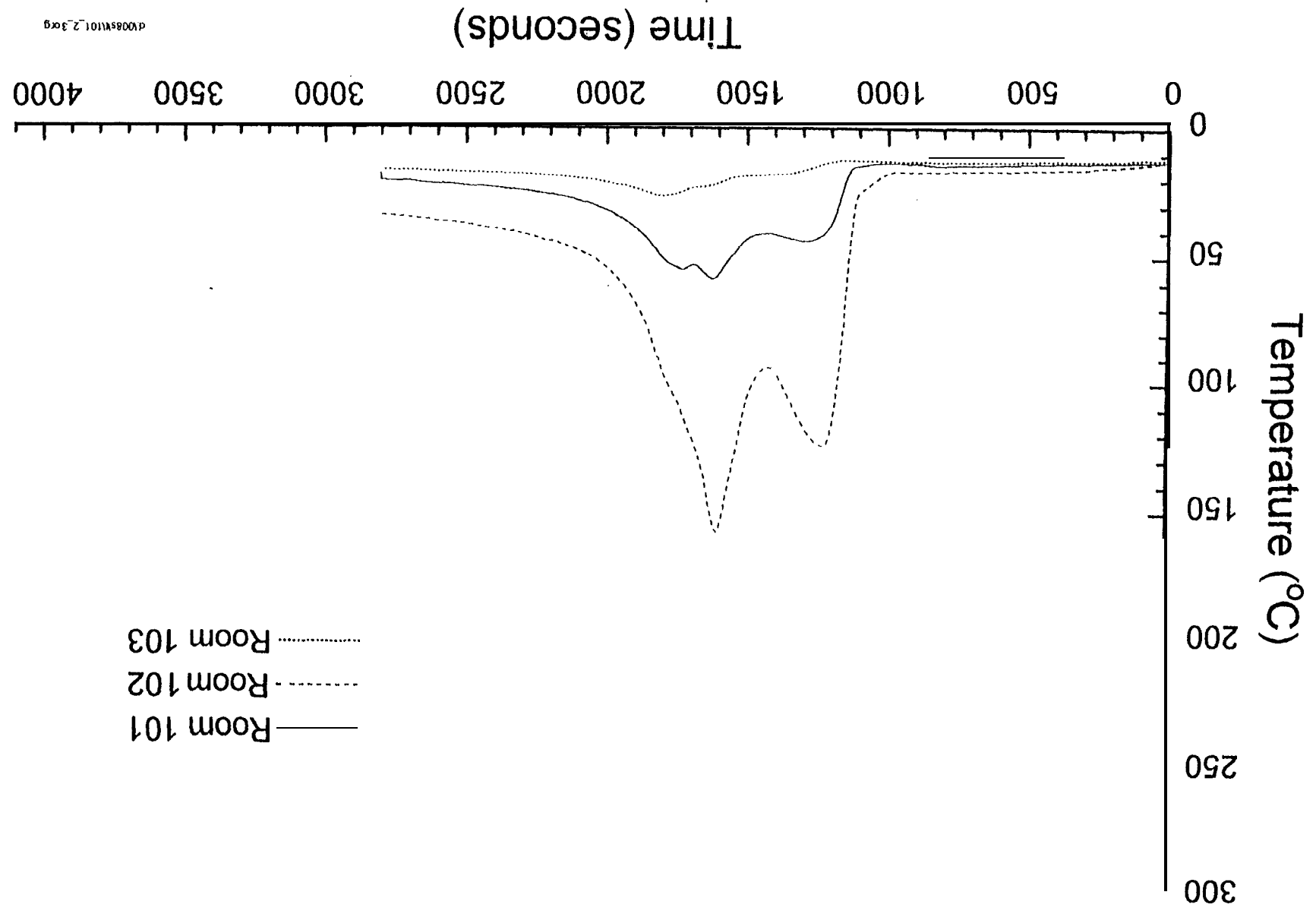

Fig. 7.2.2-3

Average room temperatures (Flaming fire in small room) - Test FMS3

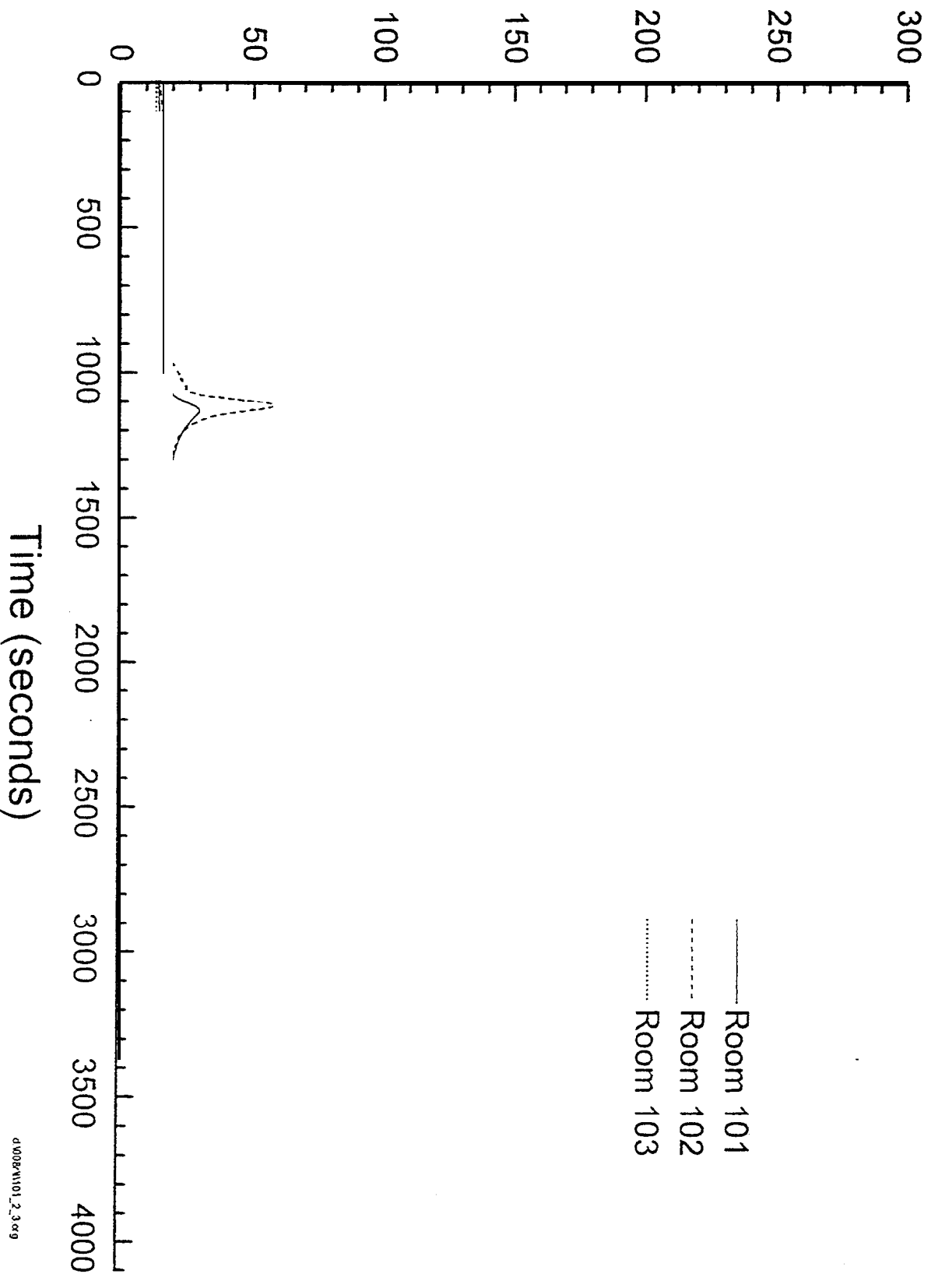

Fig. 7.2.3-1
Temperatures along corridor (Flaming fire in small room) - Test FMS1

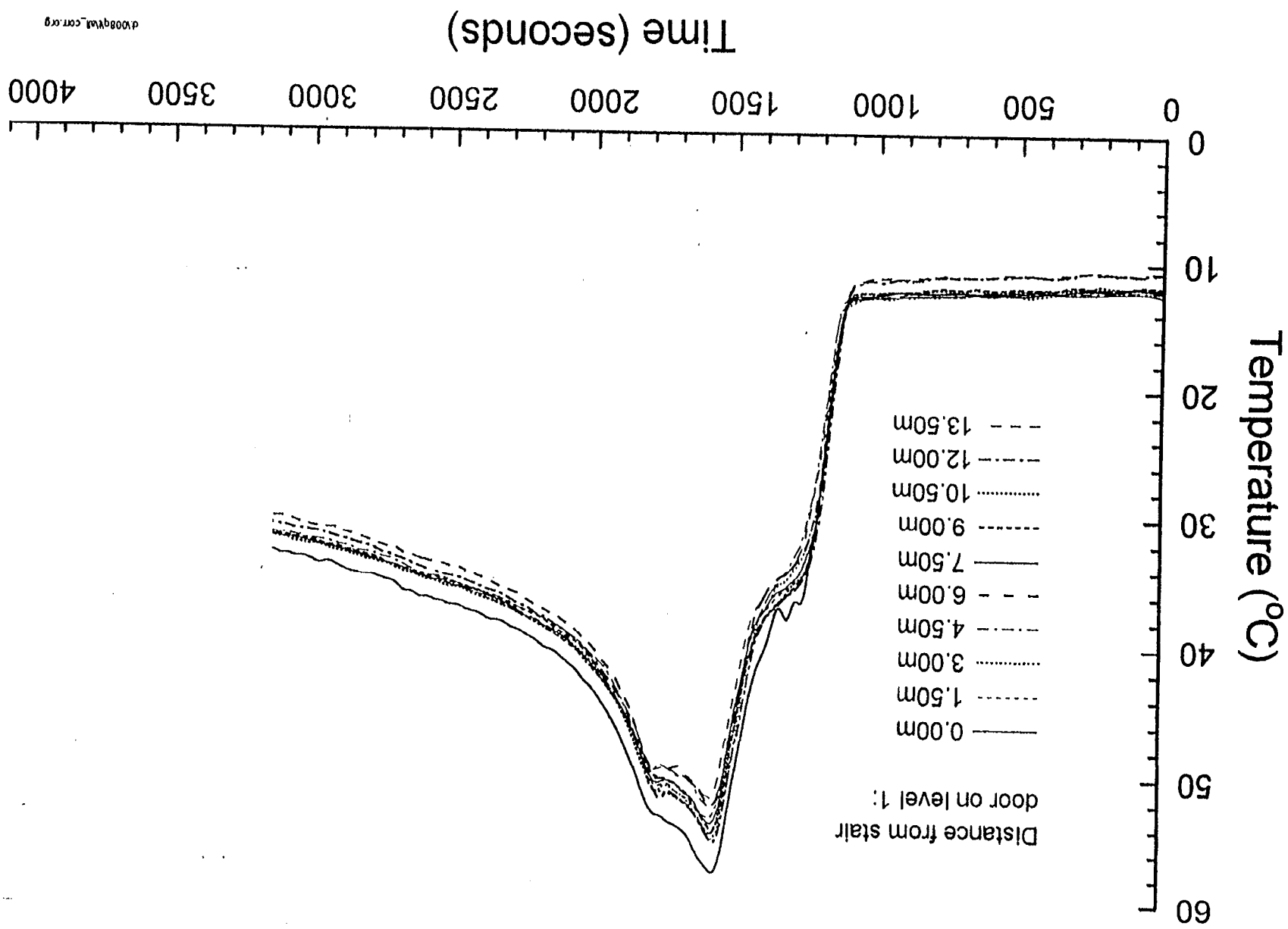
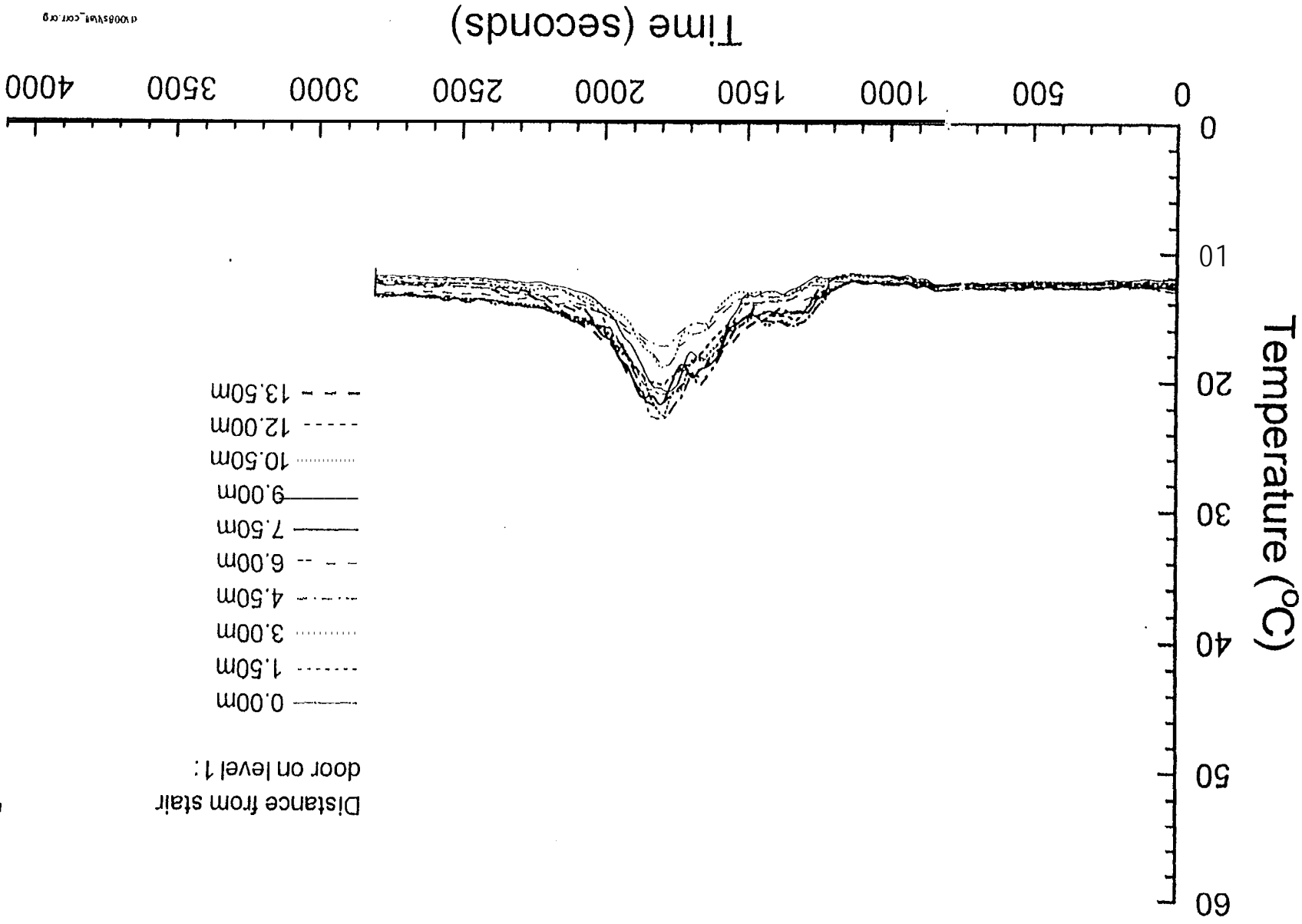
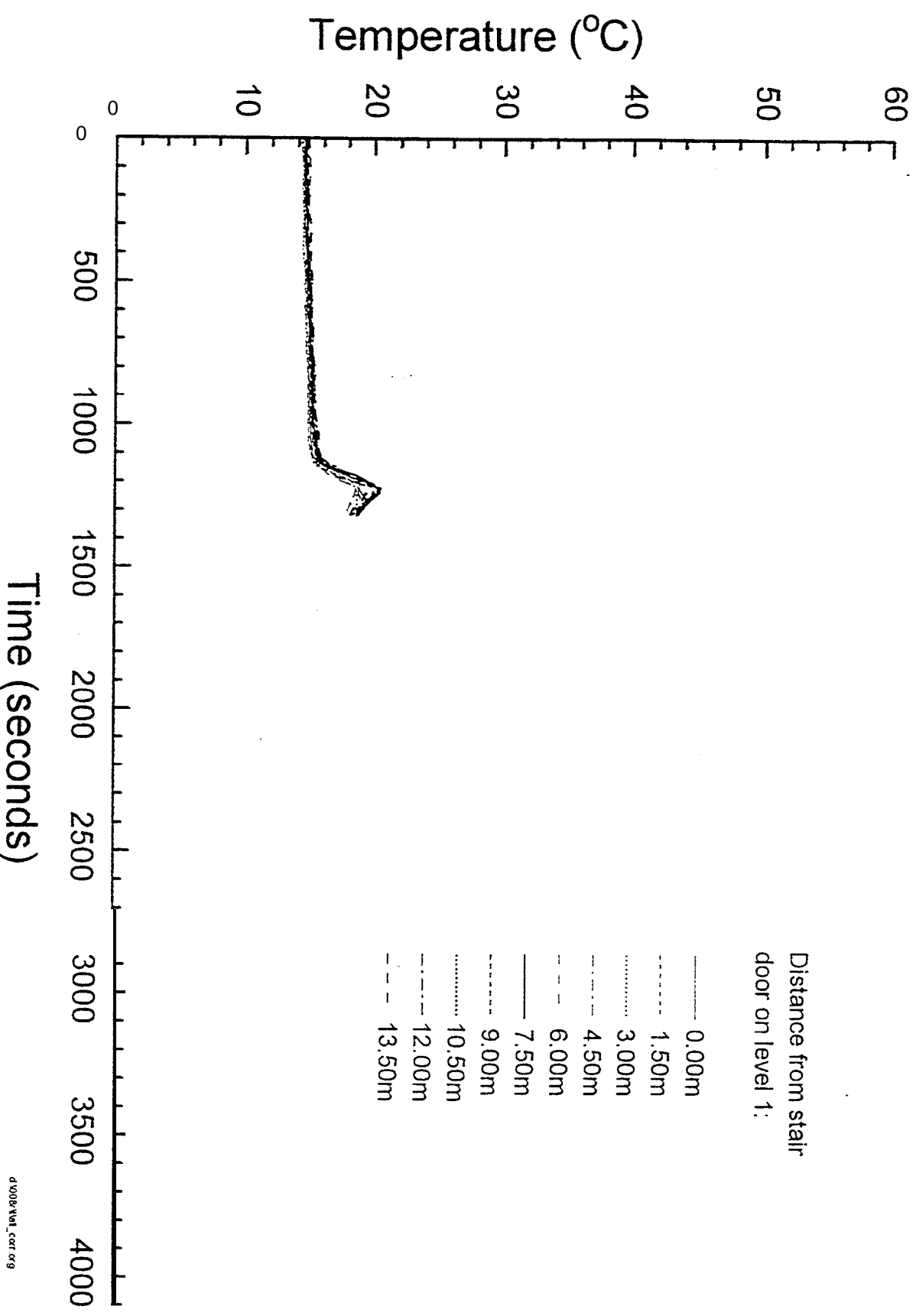

Fig. 7.2.3-2 Temperatures along corridor (Flaming fire in small room) - Test FMS2



Temperatures along corridor (Flaming fire in small room) - Test FMS3

fig. 7.2.3-3



Temperatures in stair doorway - level 3 (Flaming fire in small room)

Fig. 7.2.3-4

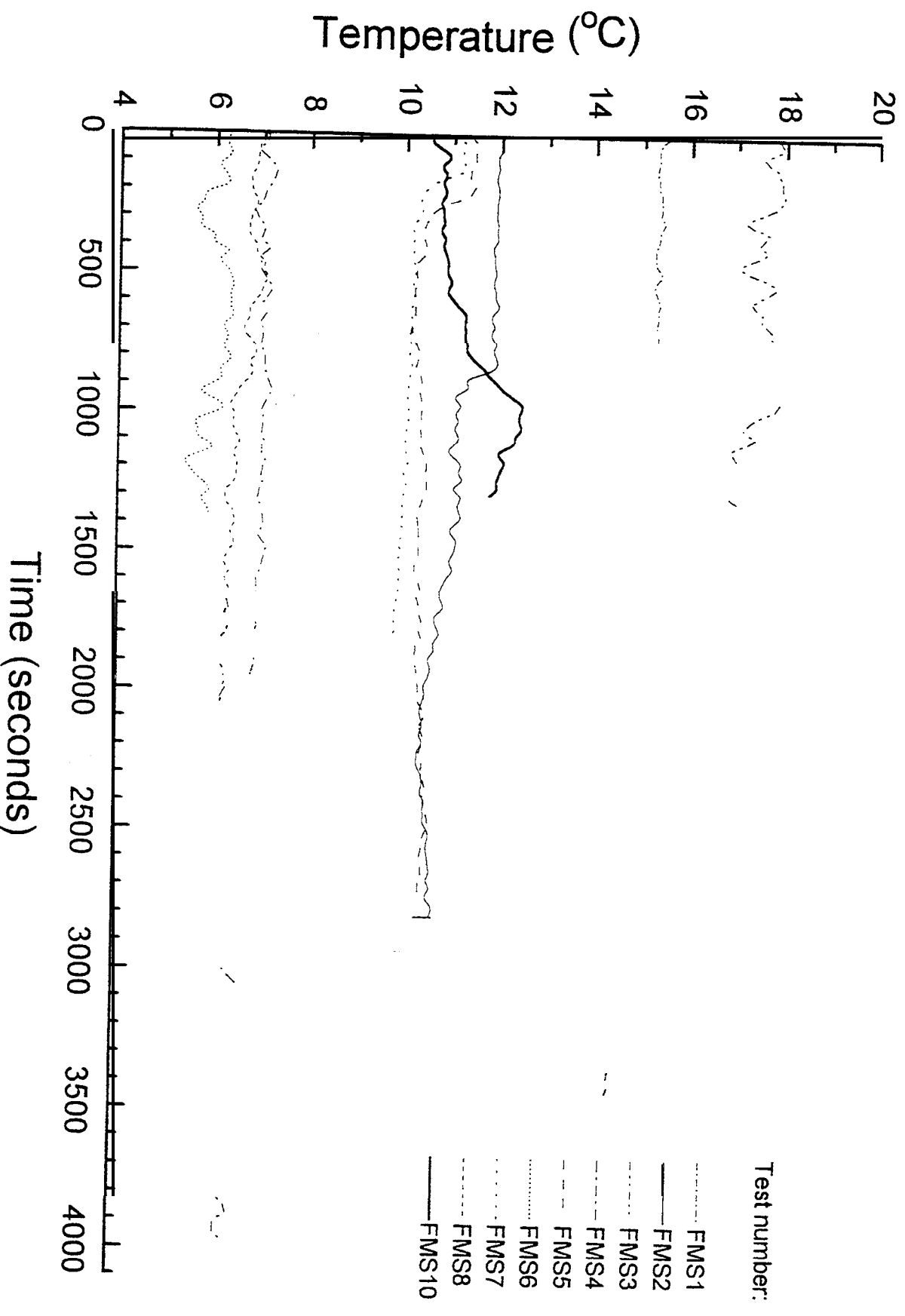

Fig. 7.2.4-1

Radiative heat flux (Flaming fire in small room) - Test FMS1

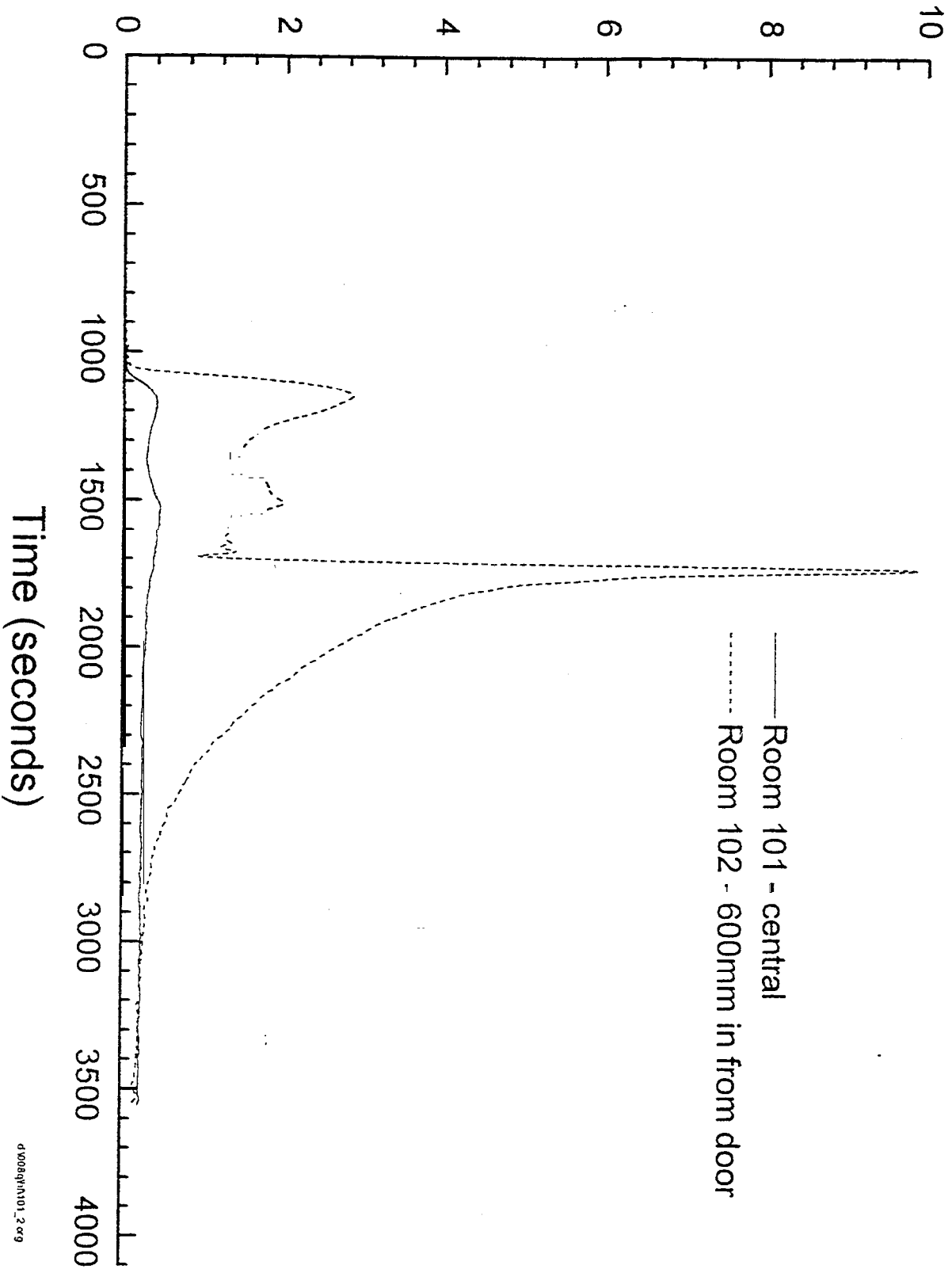

Fig. 7.2.4-2 Radiative heat flux (Flaming fire in small room) - Test FMS2

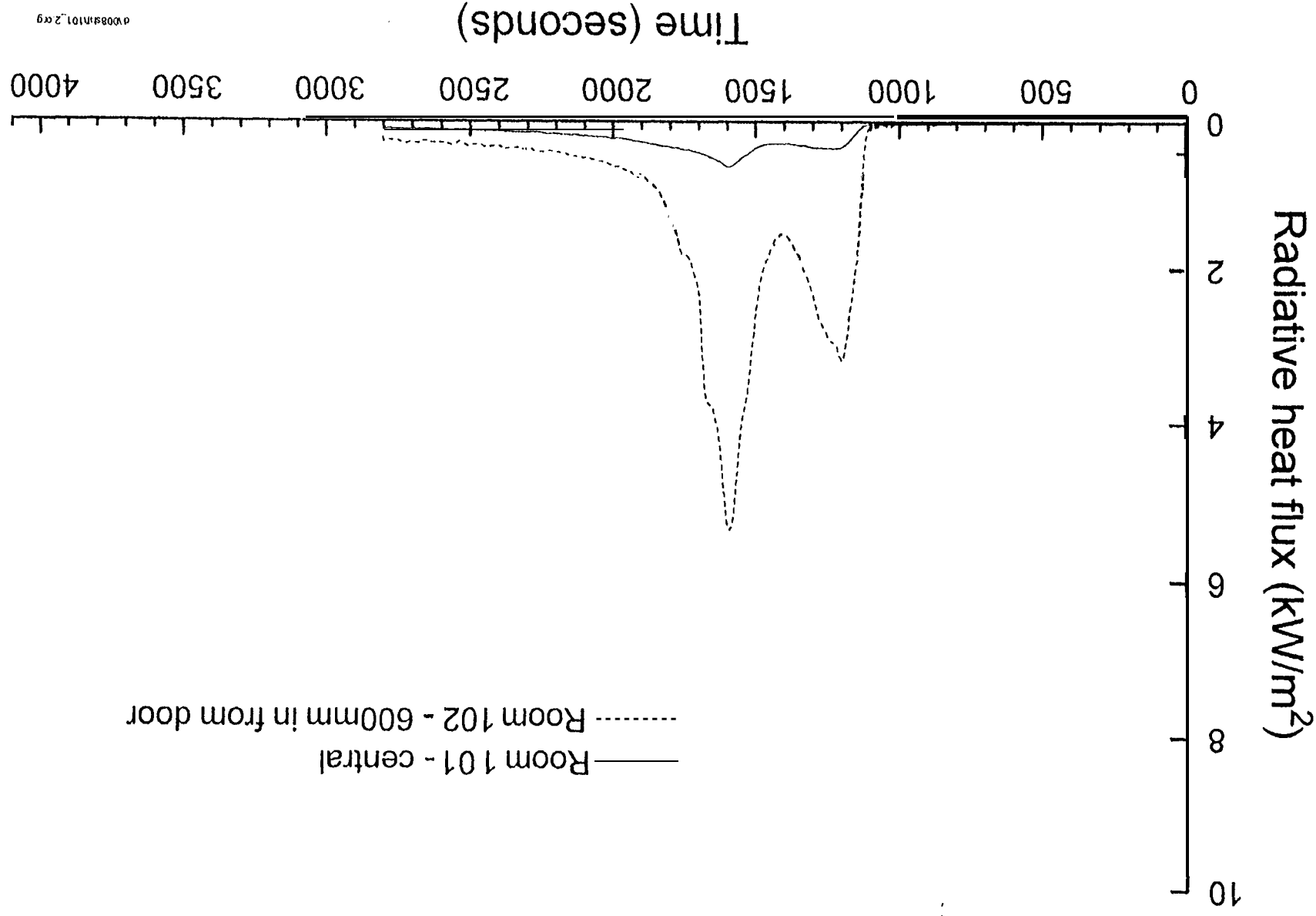
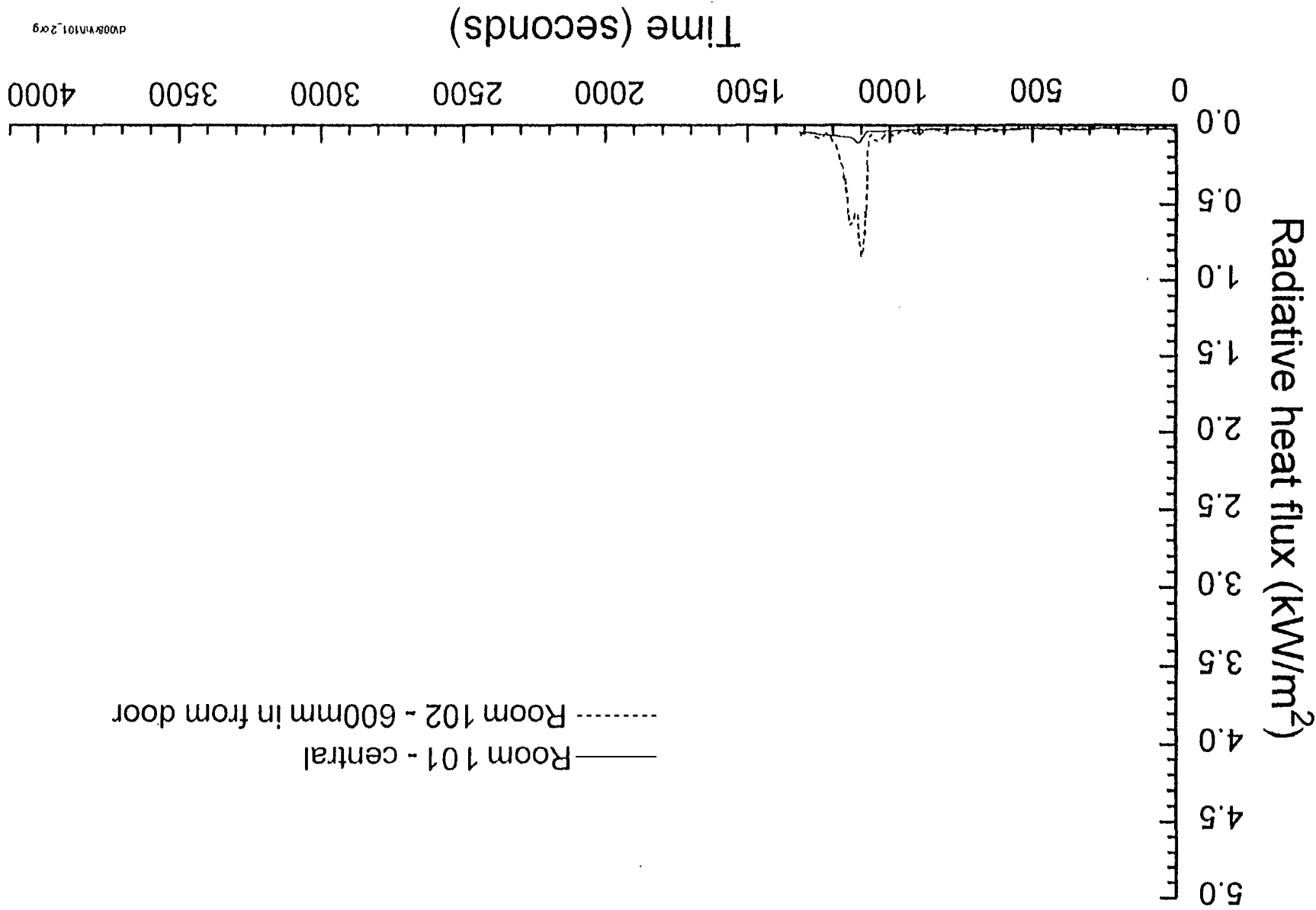

Fig. 7.2.4-3 Radiative heat flux (Flaming fire in small room) - Test FMS3



D:\008\101_2\09

Fig. 7.2.5-1

Carbon monoxide concentration (Flaming fire in sm all room) - Test FMS1
At 1900mm high in doorways

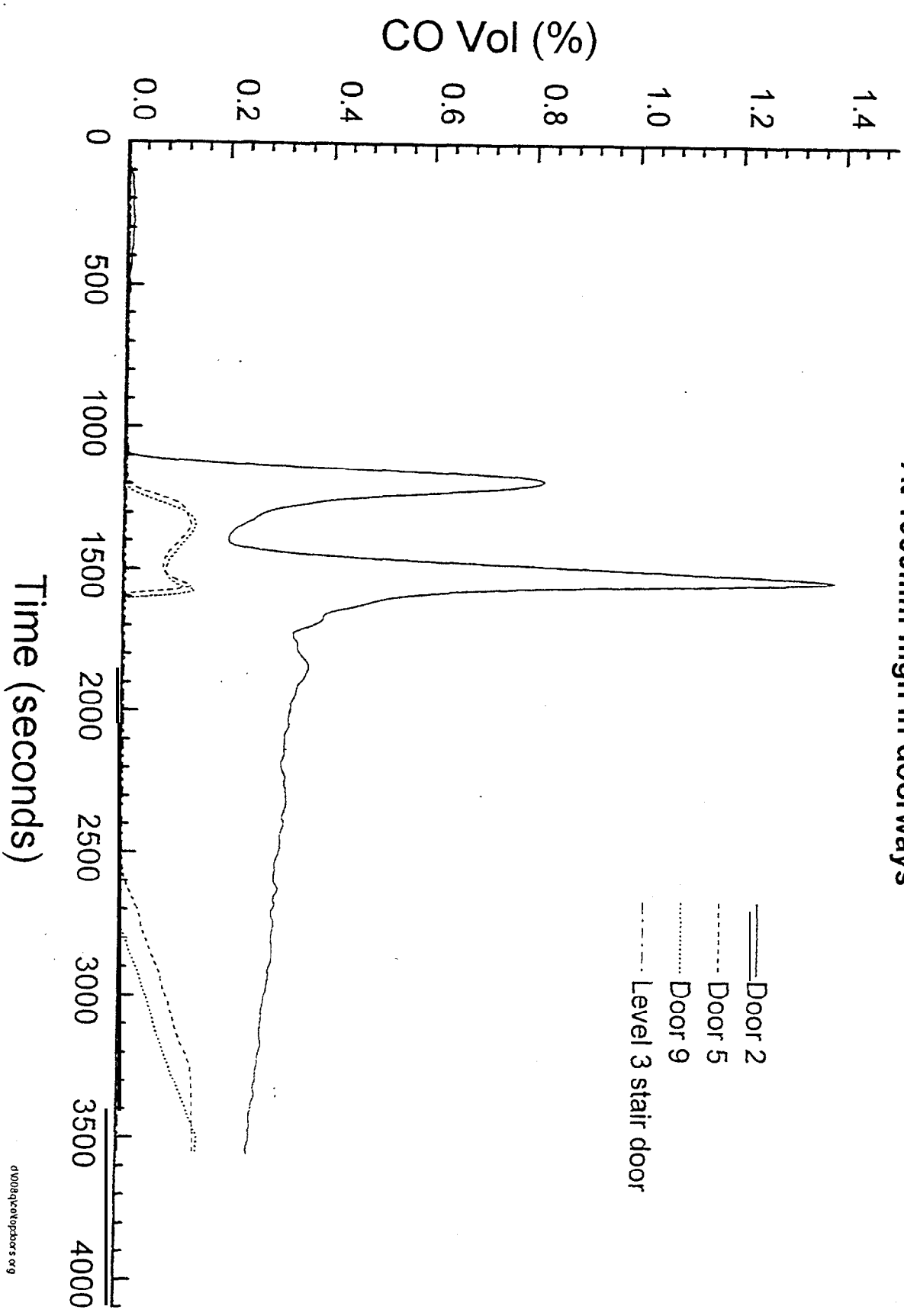

Carbon monoxide concentration (Flaming fire in small room) - Test FMS2

At 190mm high in doorways

Fig. 7.2.5-2

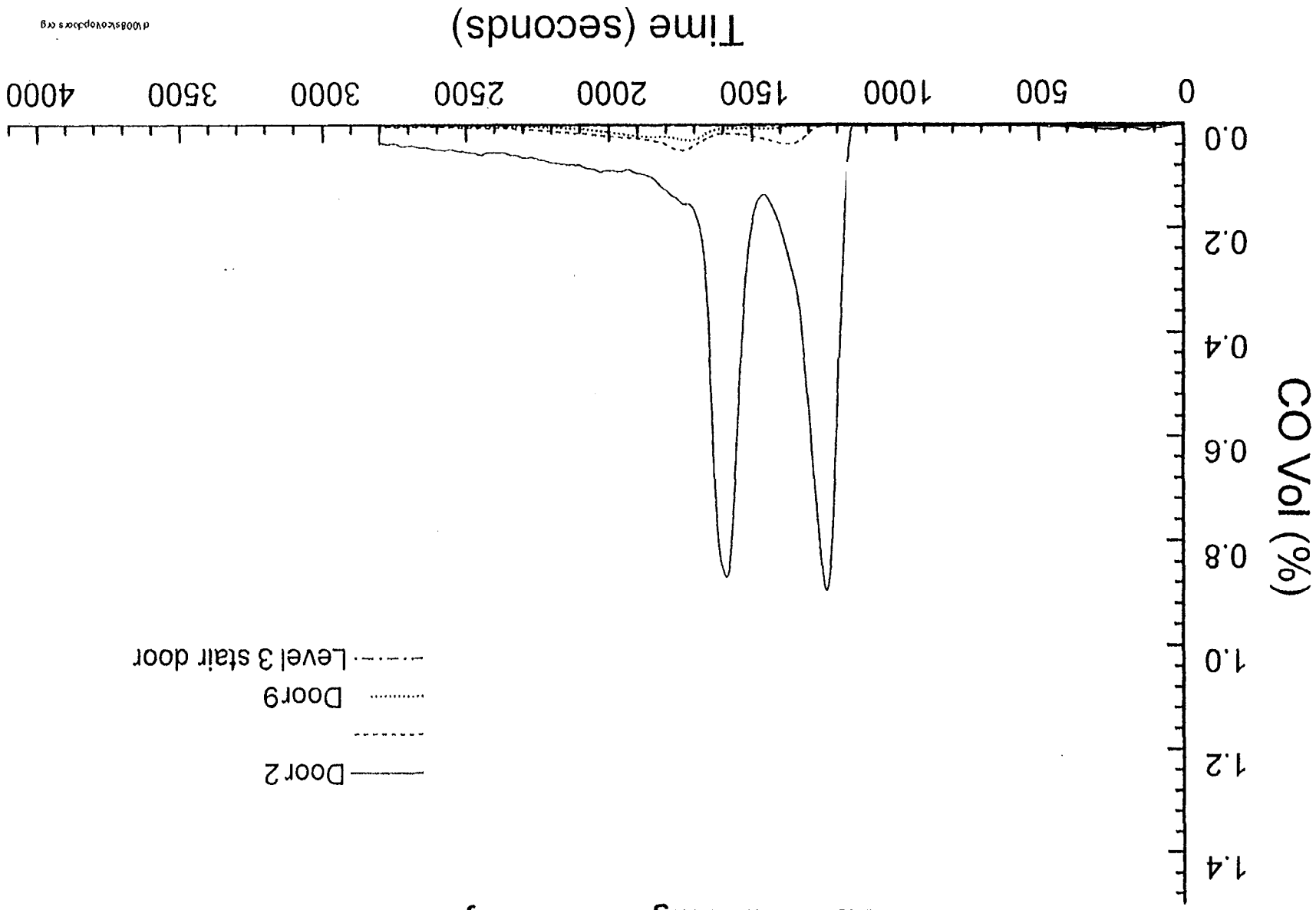
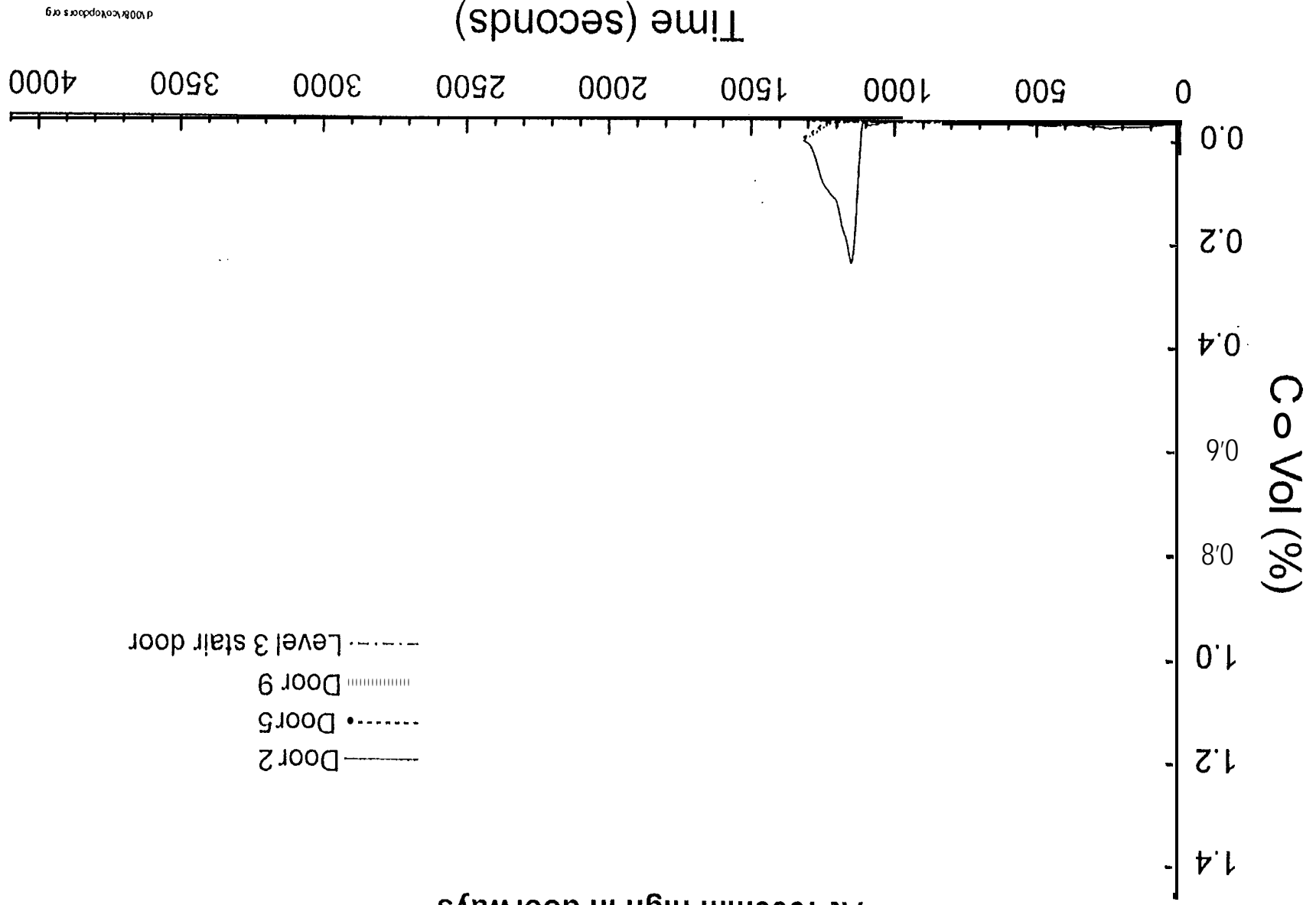

Fig. 7.2.5-3
Carbon monoxide concentration (Flaming fire in small room) - Test FMS3
At 1900mm high in doorways



Oxygen concentration (Flaming fire in small room) - Test FMS 1

Average of 3 points in room 102

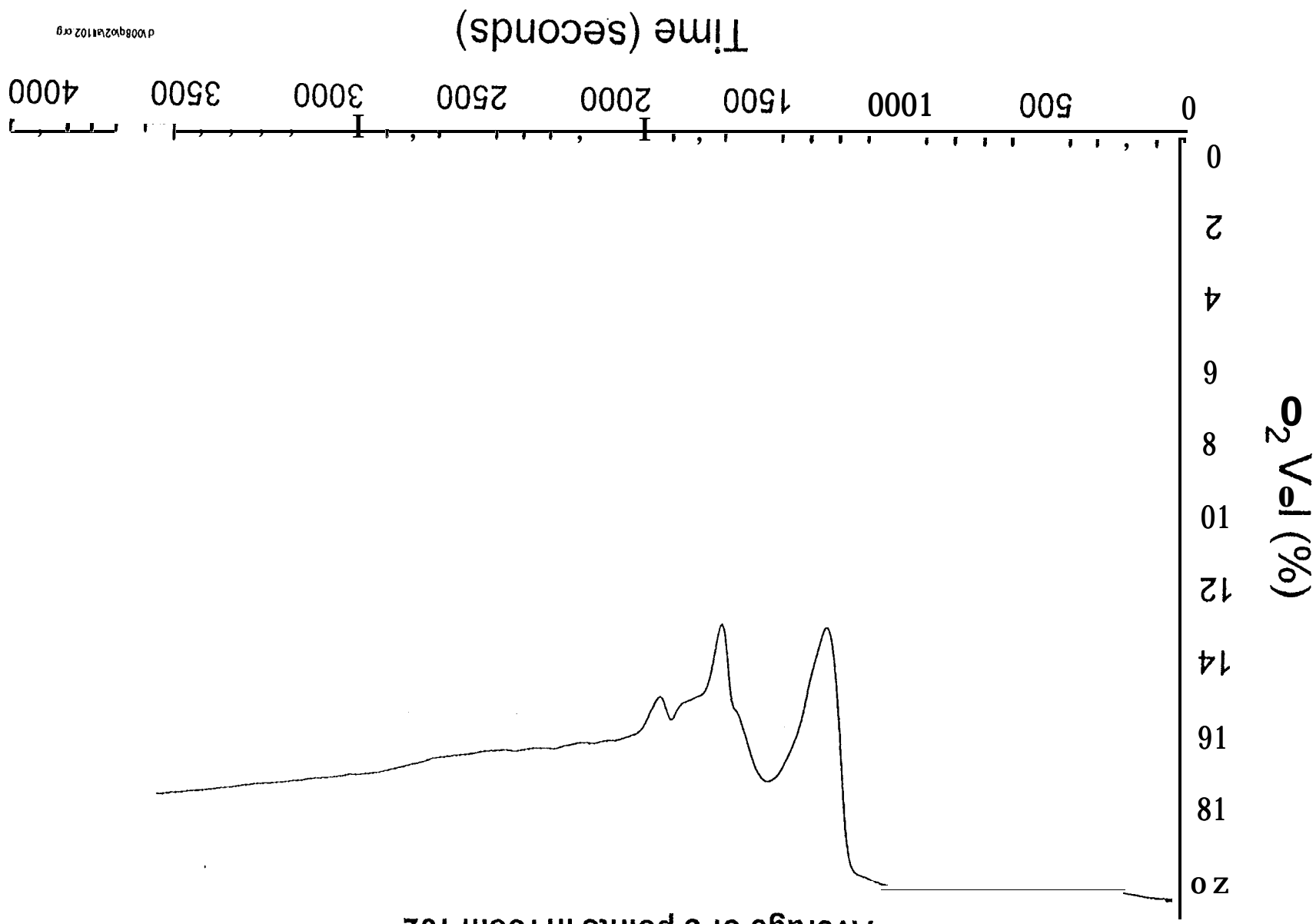

Fig. 7.2.6-1

Fig. 7.2.6-2

Oxygen concentration in flaming fire in small room) - Test MS 2

Average of 3 points in room 102

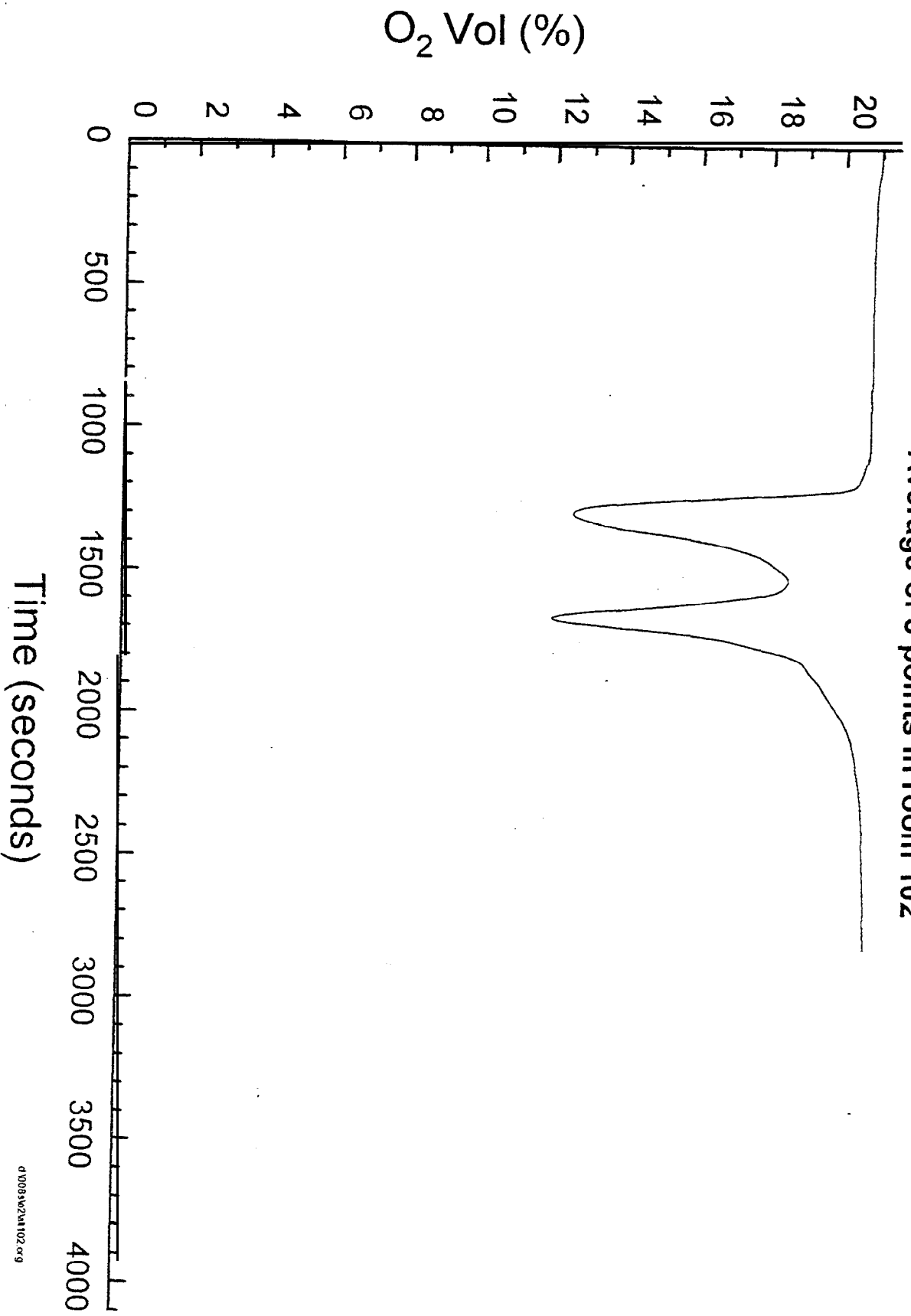
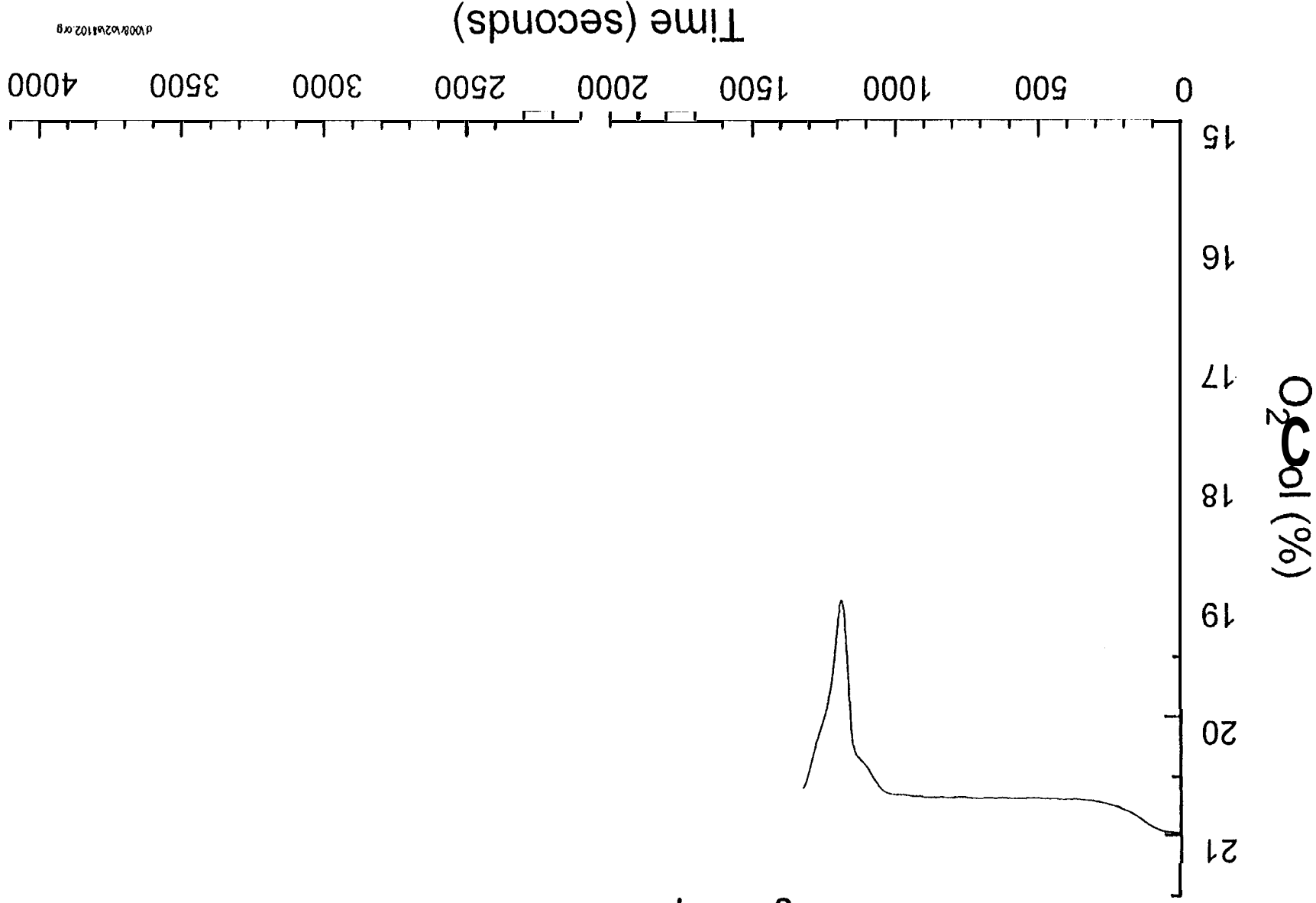

Fig. 7.2.6-3
(flaming fire in small room) - Test FMS 3

Average of 3 points in room 102



P008/6261102.rg

Carbon dioxide and Oxygen concentrations - Test [MS2

Fig. 7.2.6-5

(Flaming fire in small room)

At various heights in

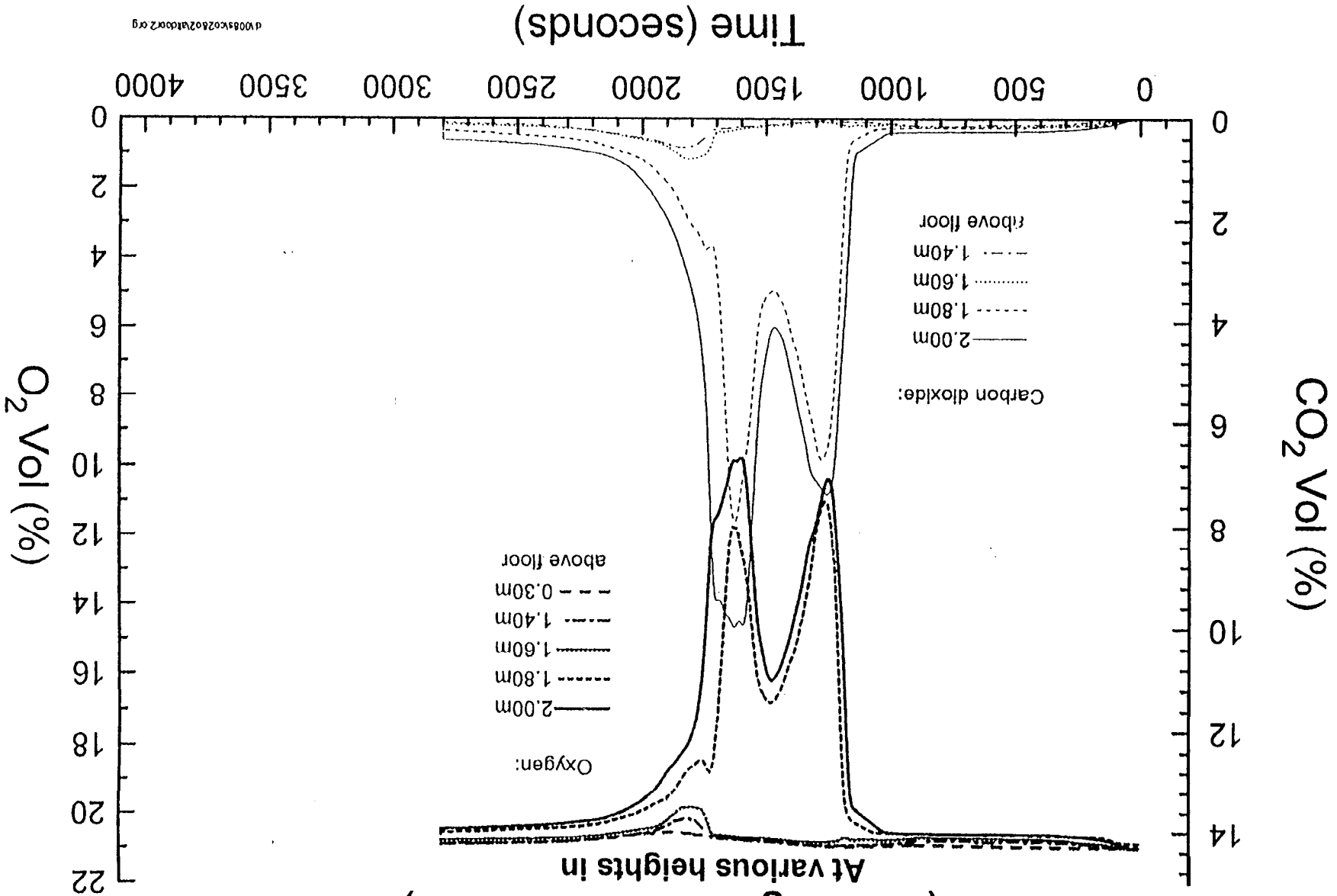

Fig. 7.2.6-4
Carbon dioxide and Oxygen concentrations - Test FMS1
(Flaming fire in small room)
At various heights in door 2

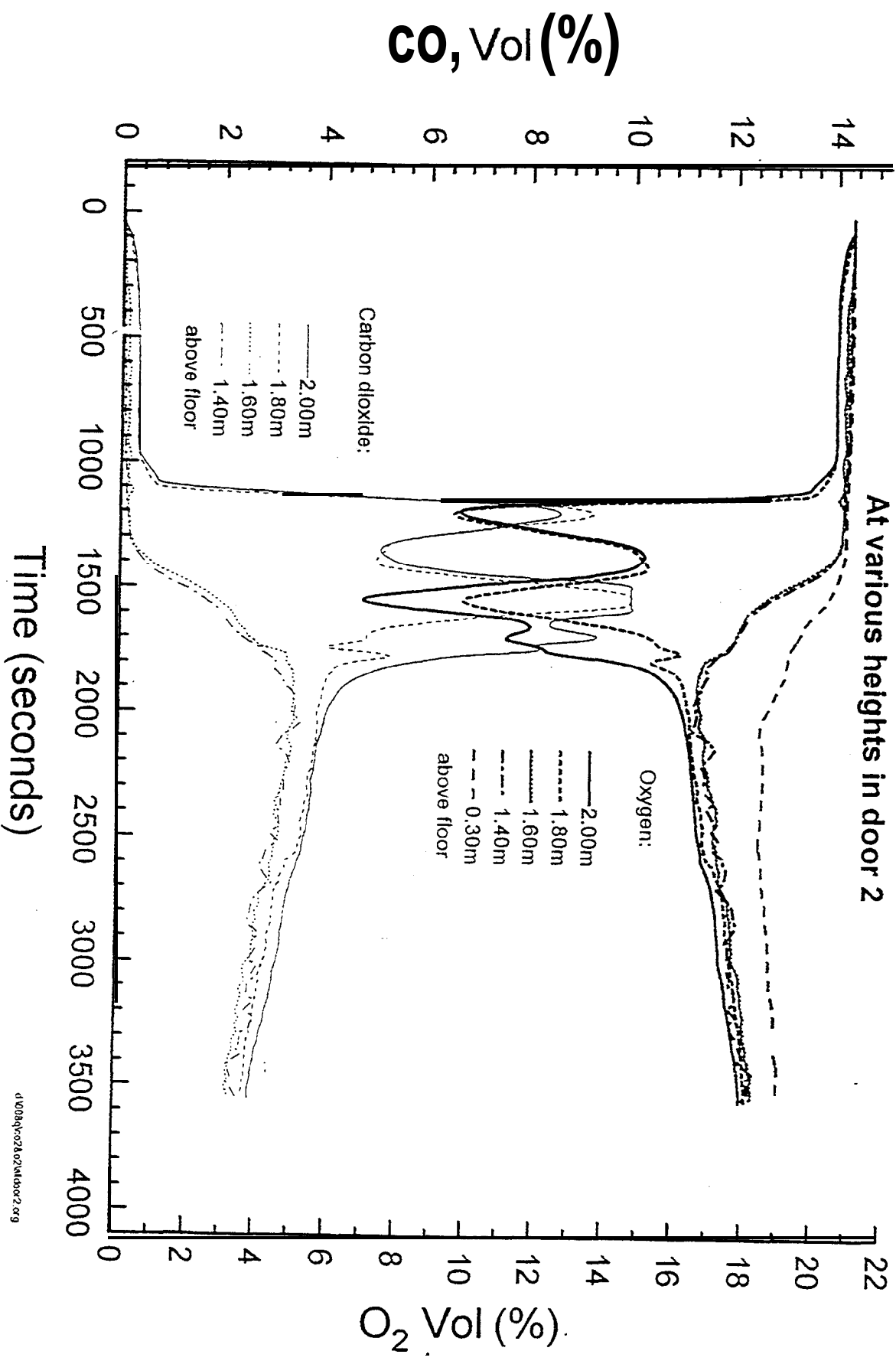

Fig. 7.2.6-6

Carbon dioxide and Oxygen concentrations - Test #MS3

(Flaming fire in small room)

At various heights in door 2

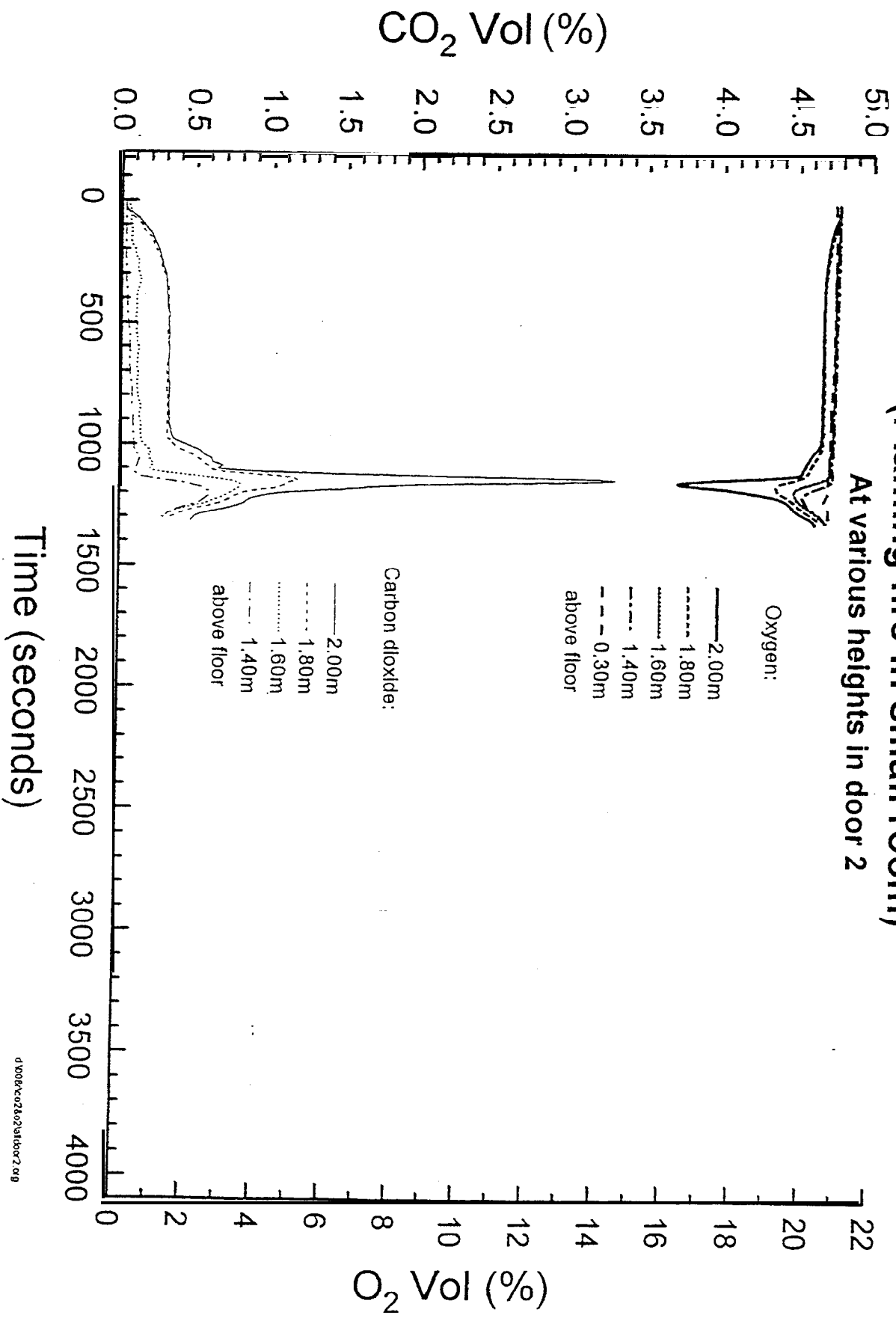

Fig. 7.2.7-1
Smoke obscuration and temperature - Test FMS1
(Kitchen fire)

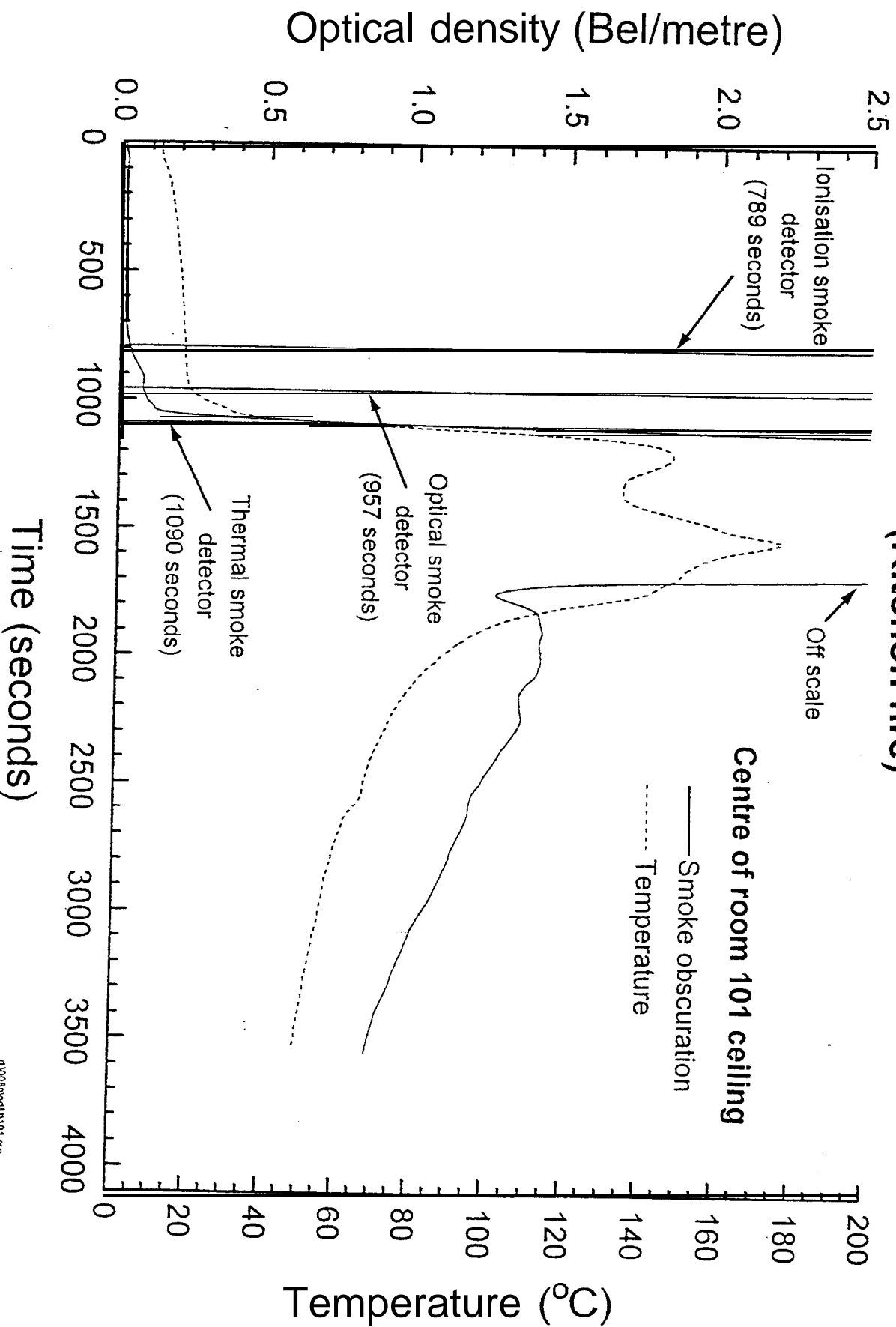

Fig. 7.2.7-2

Smoke obscuration and temperature - Test FMS2

(Kitchen fire)

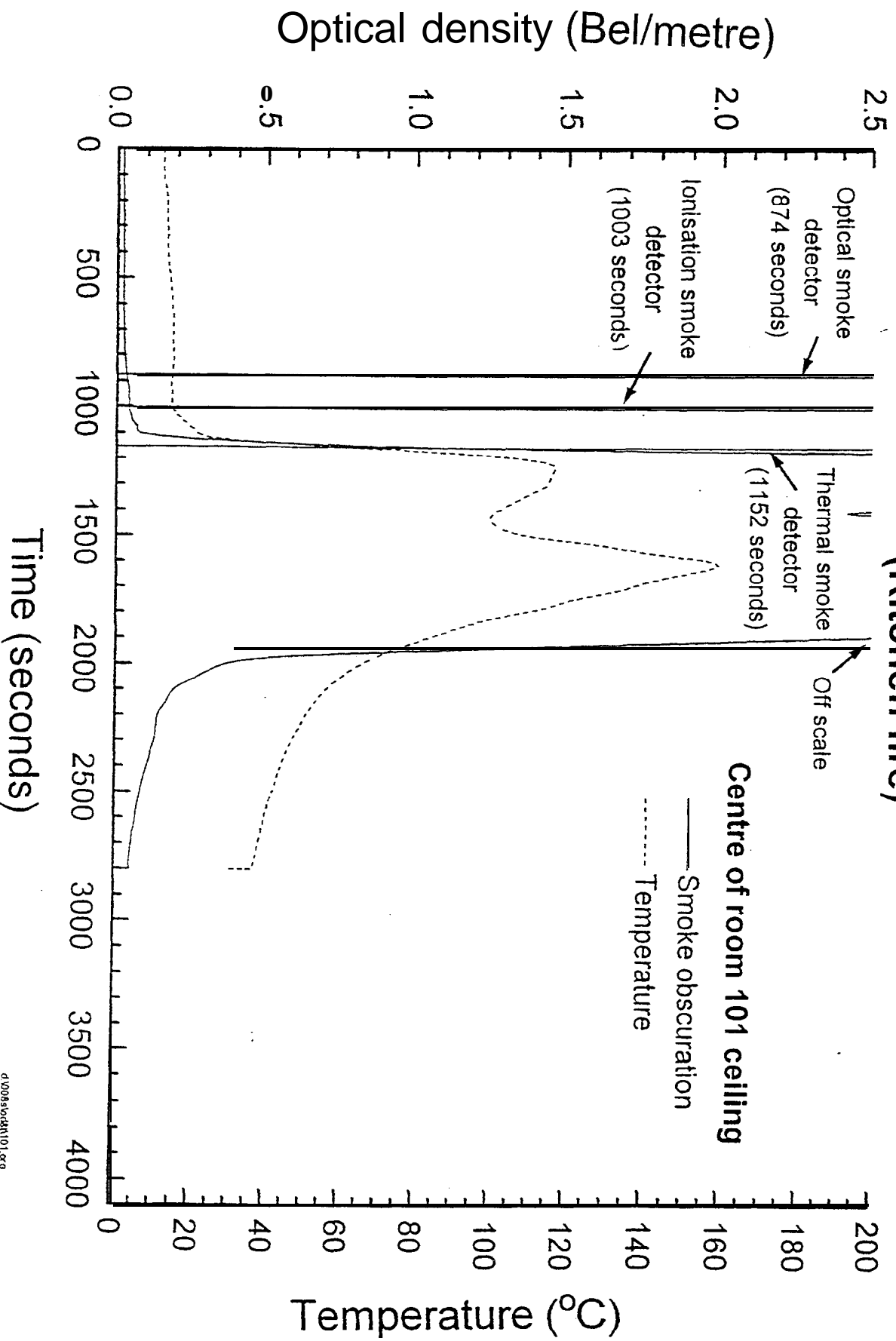
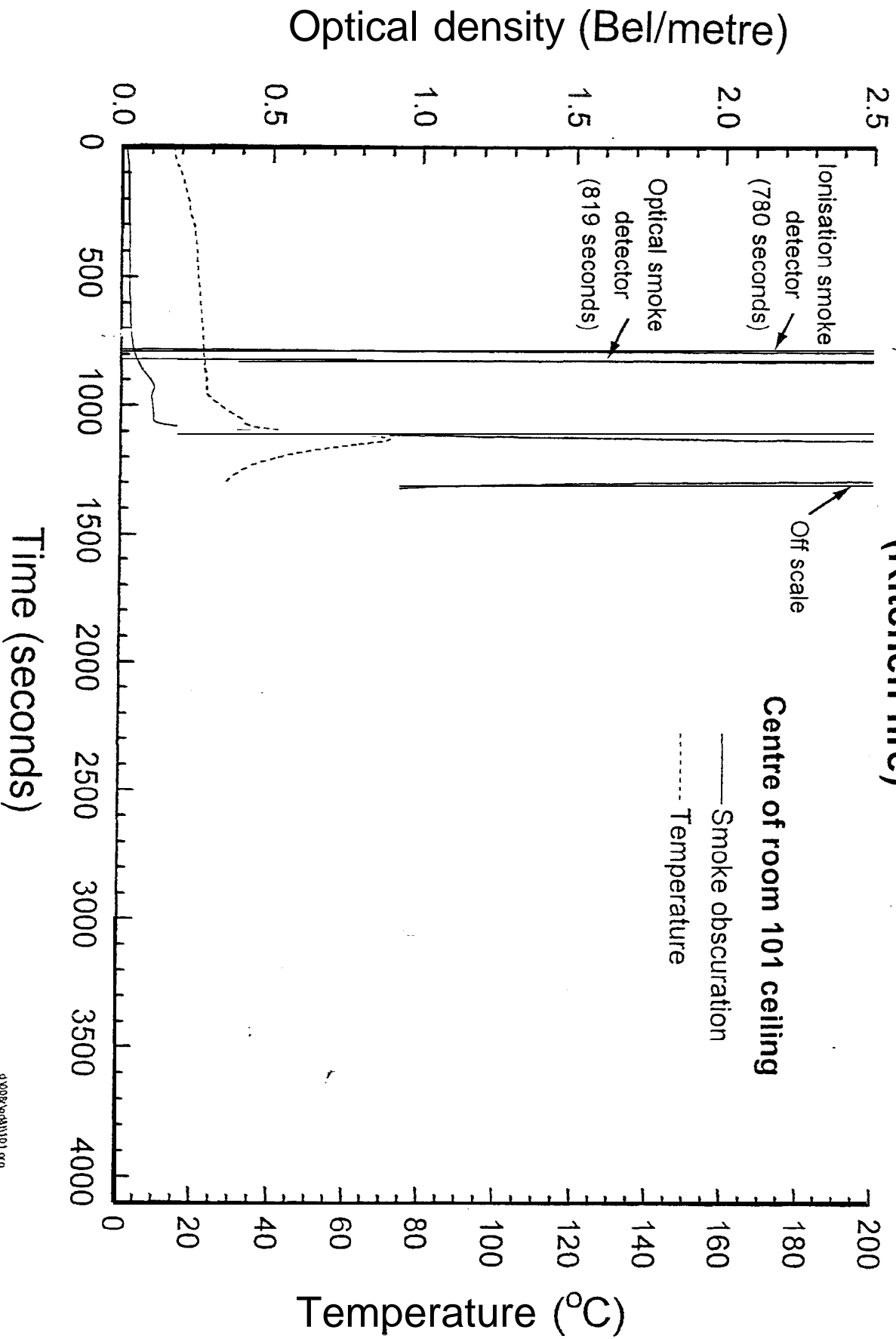

Fig. 7.2.7-3

Smoke obscuration and temperature - Test FMS3 (Kitchen fire)



Smoke obscuration and temperature - Test FMS1

Fig. 7.2.7-4

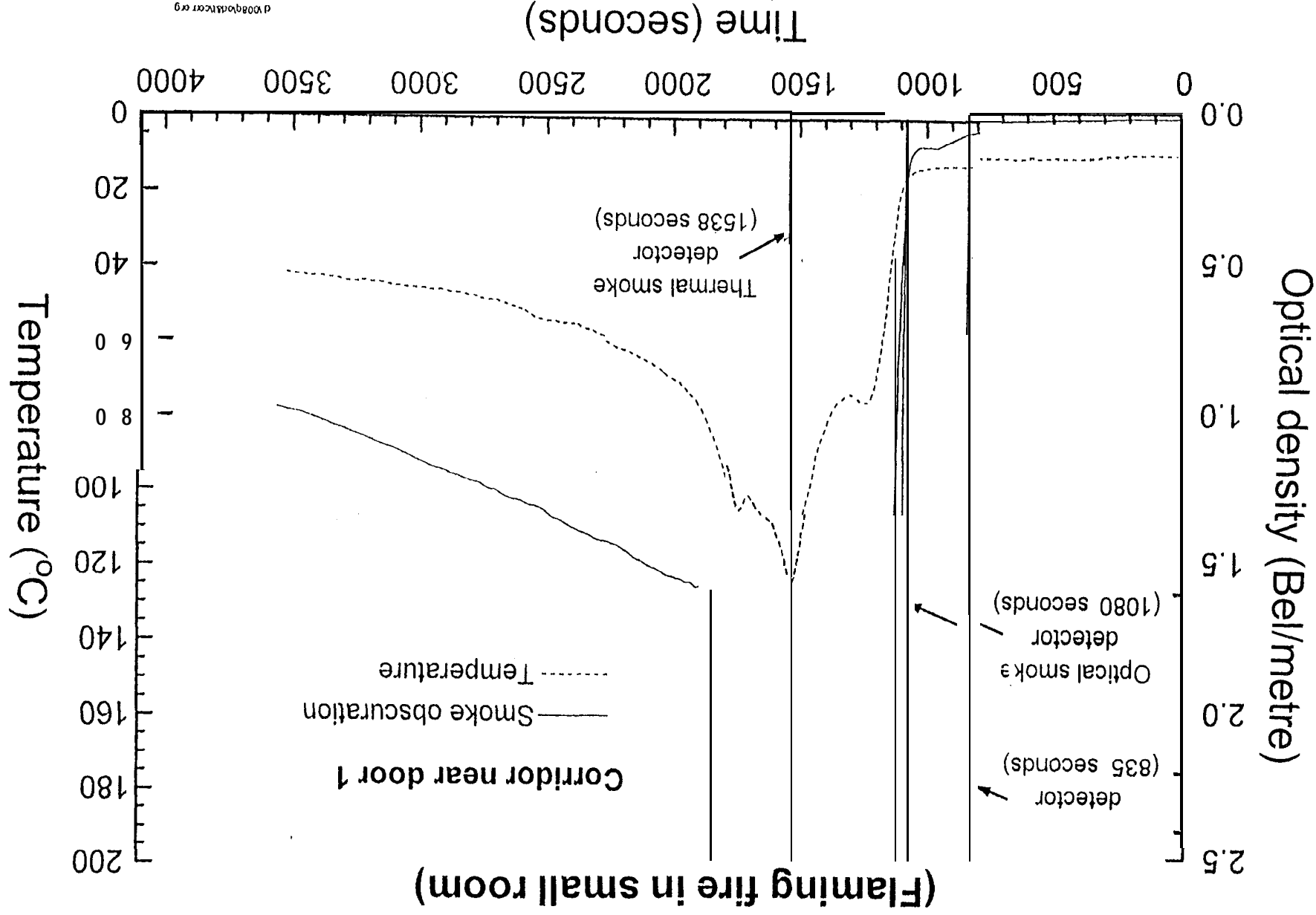

Smoke obscuration and temperature - Test FMS2

Fig. 7.2.7-5

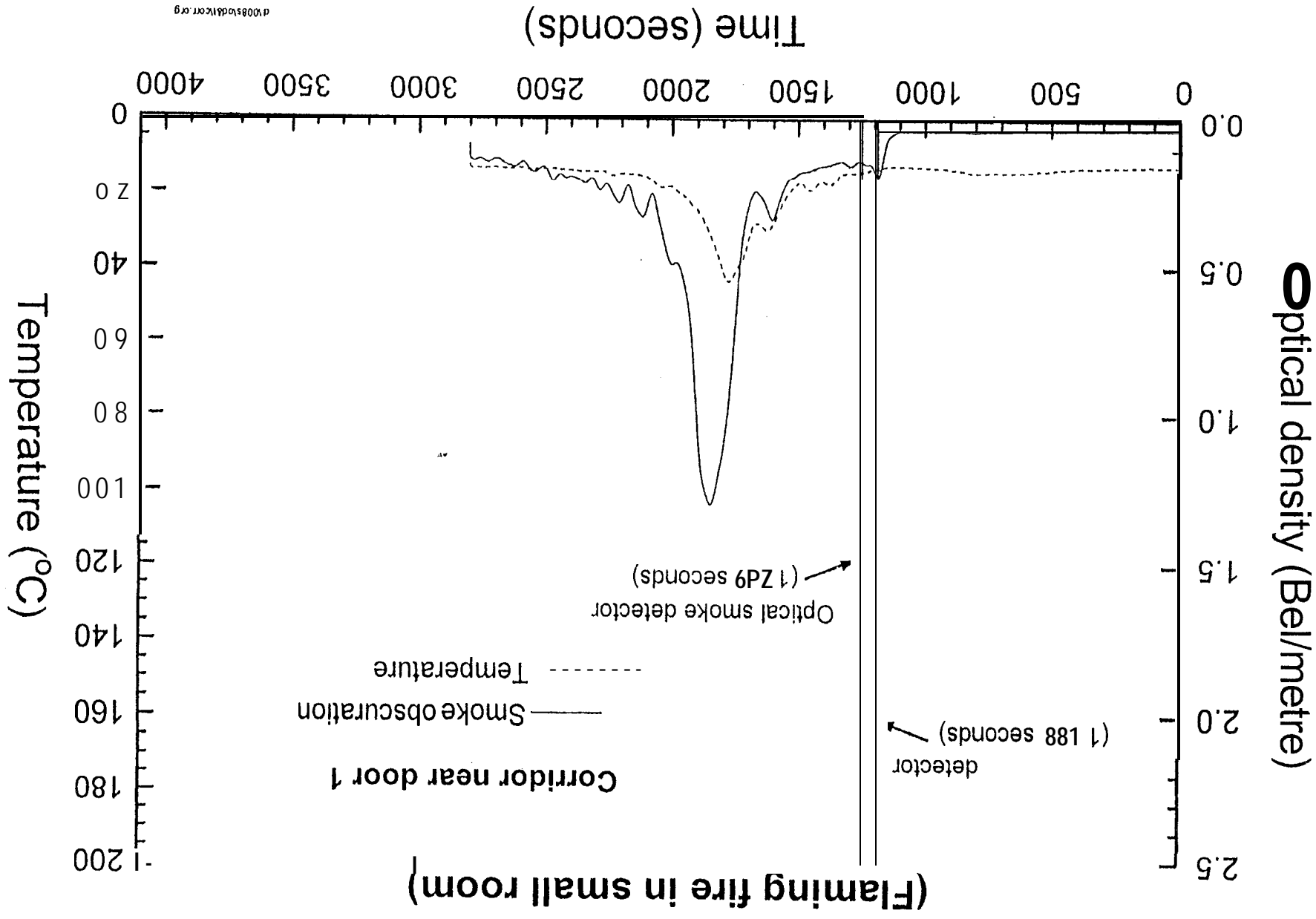

Fig. 7.2.7-6

Smoke obscuration and temperature - Test FMS3

(Flaming fire in small room)

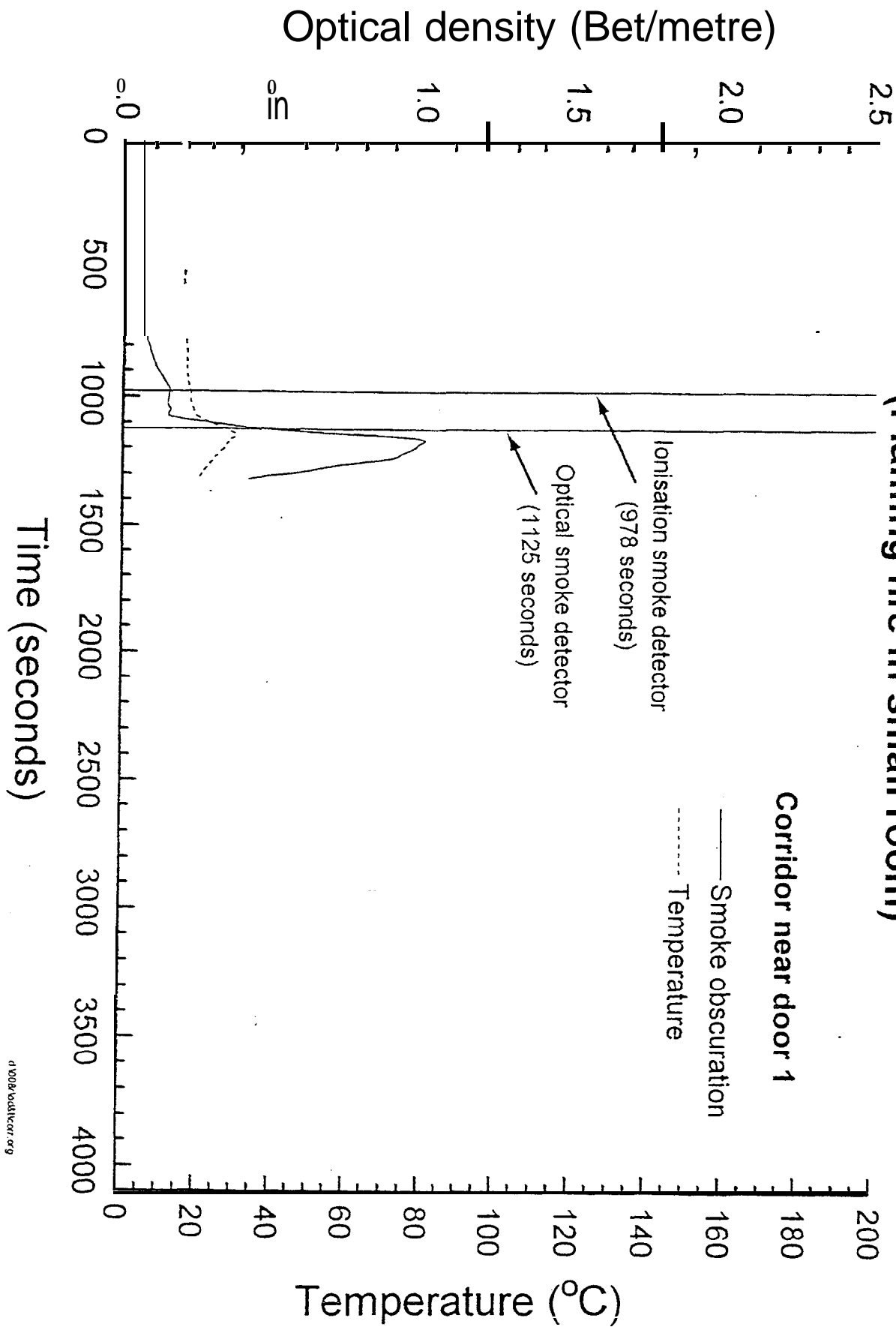

Fig. 7.2.7-7

Smoke obscuration and temperature - Test FMS2

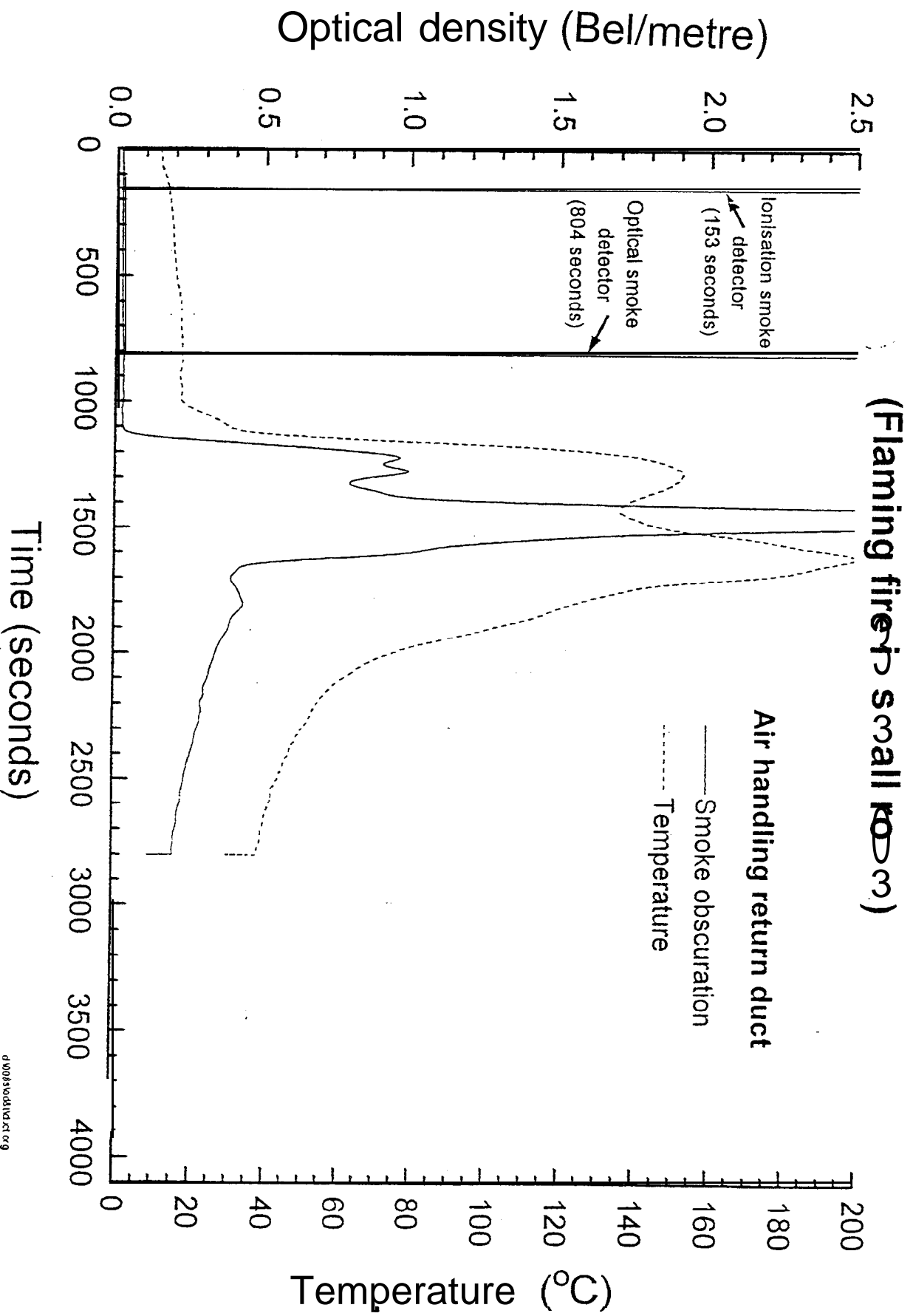
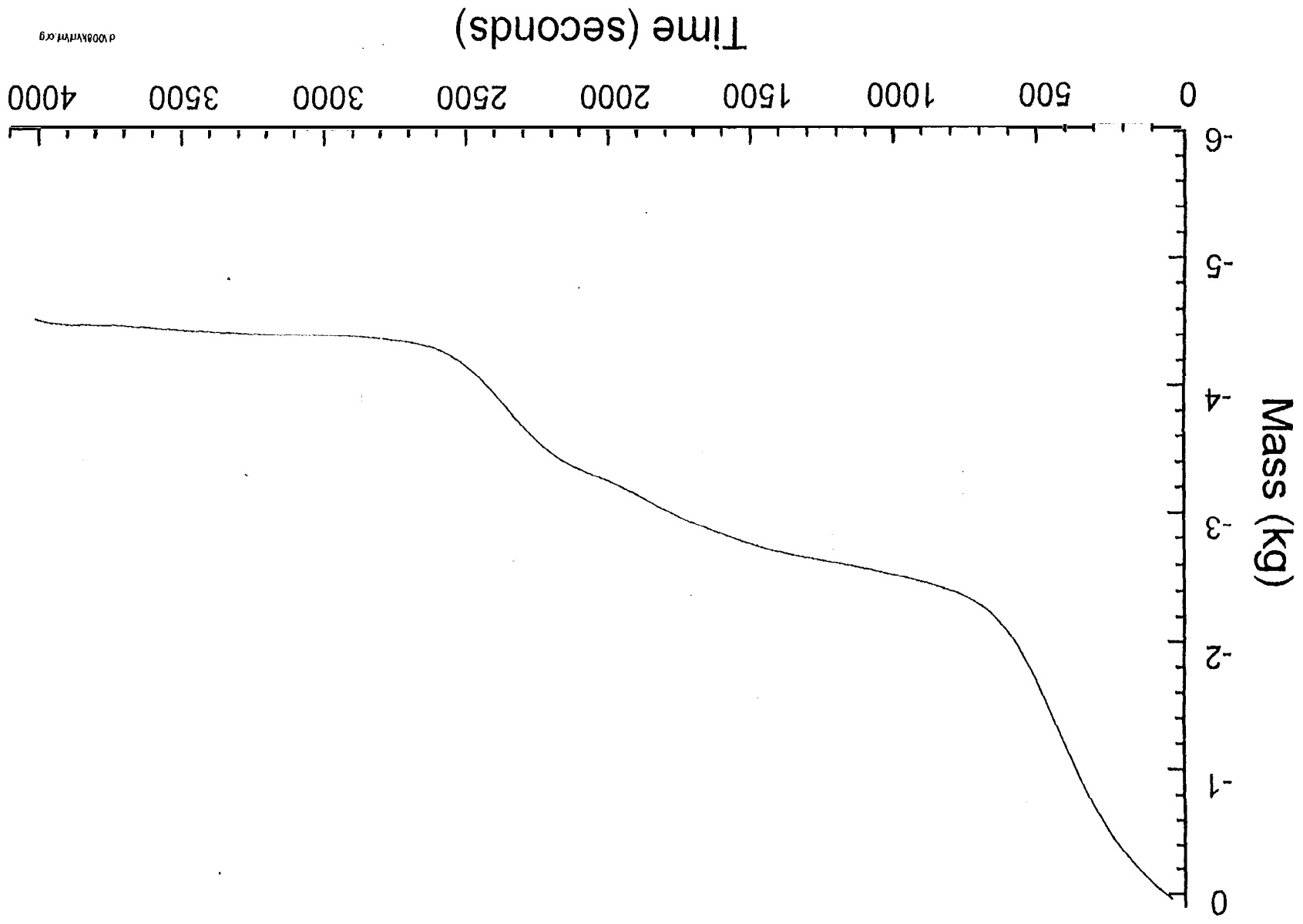

Fig. 7.3.1-1
Mass loss (Flaming fire in small room) - Test FMS4



P 0084747, 02.9

Fig. 7.3.1-2

Mass loss (Flaming fire in small room) - Test FMS5

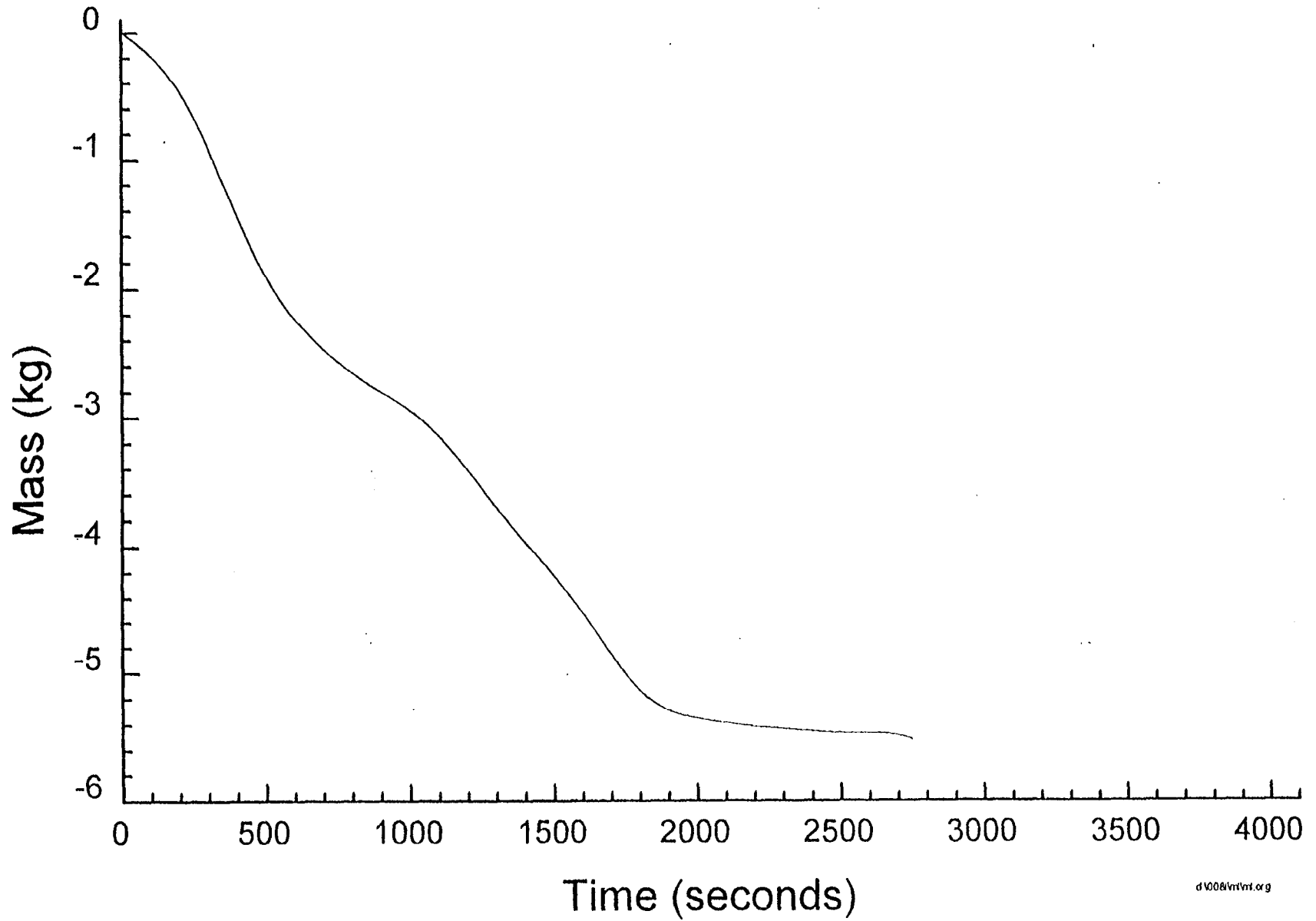

Fig. 7.3.1-3

Mass loss (Flaming fire in small room) - Test FMS6

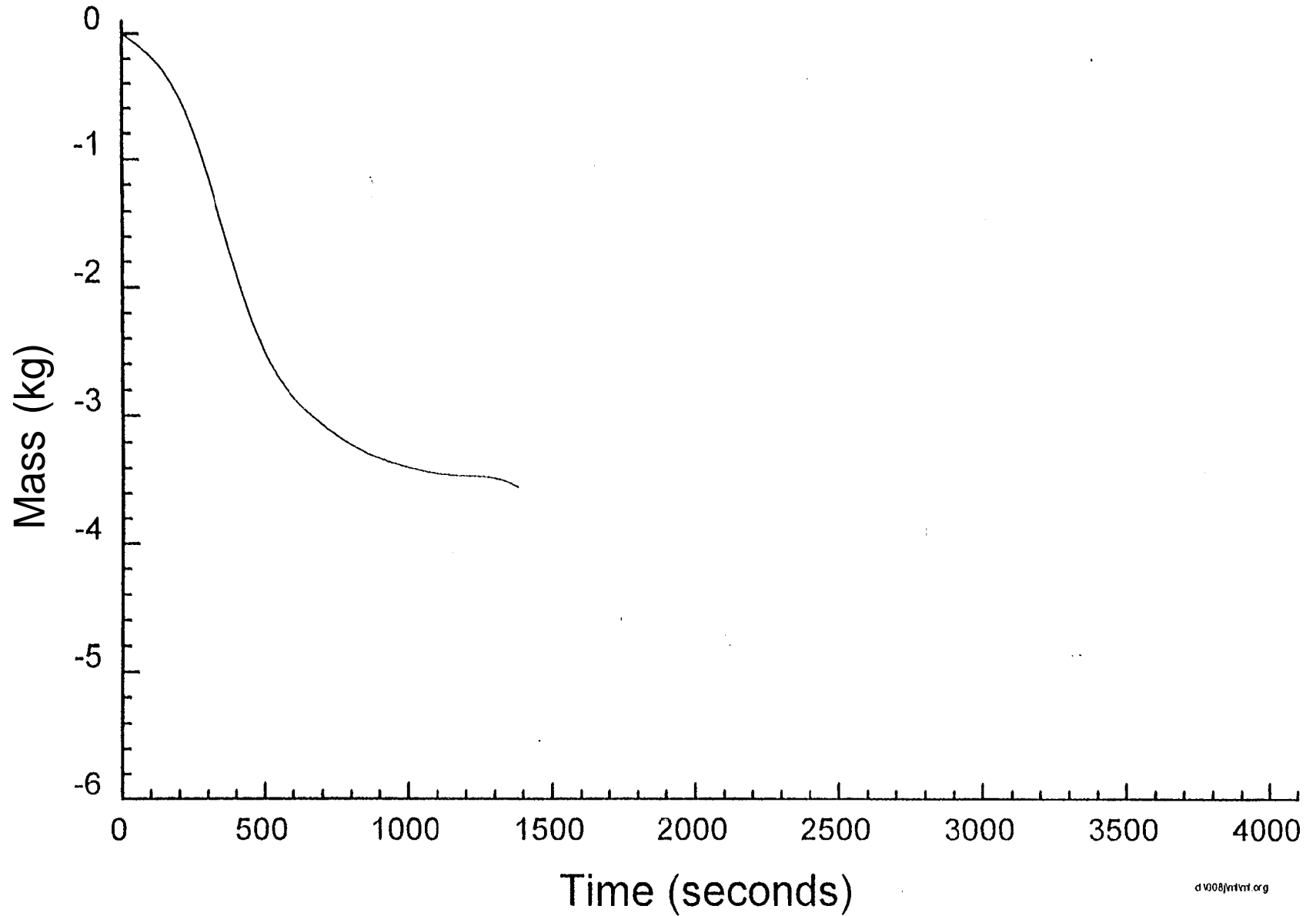

Fig. 7.3.1-4

Mass loss (Flaming fire in small room) - Test FMS7

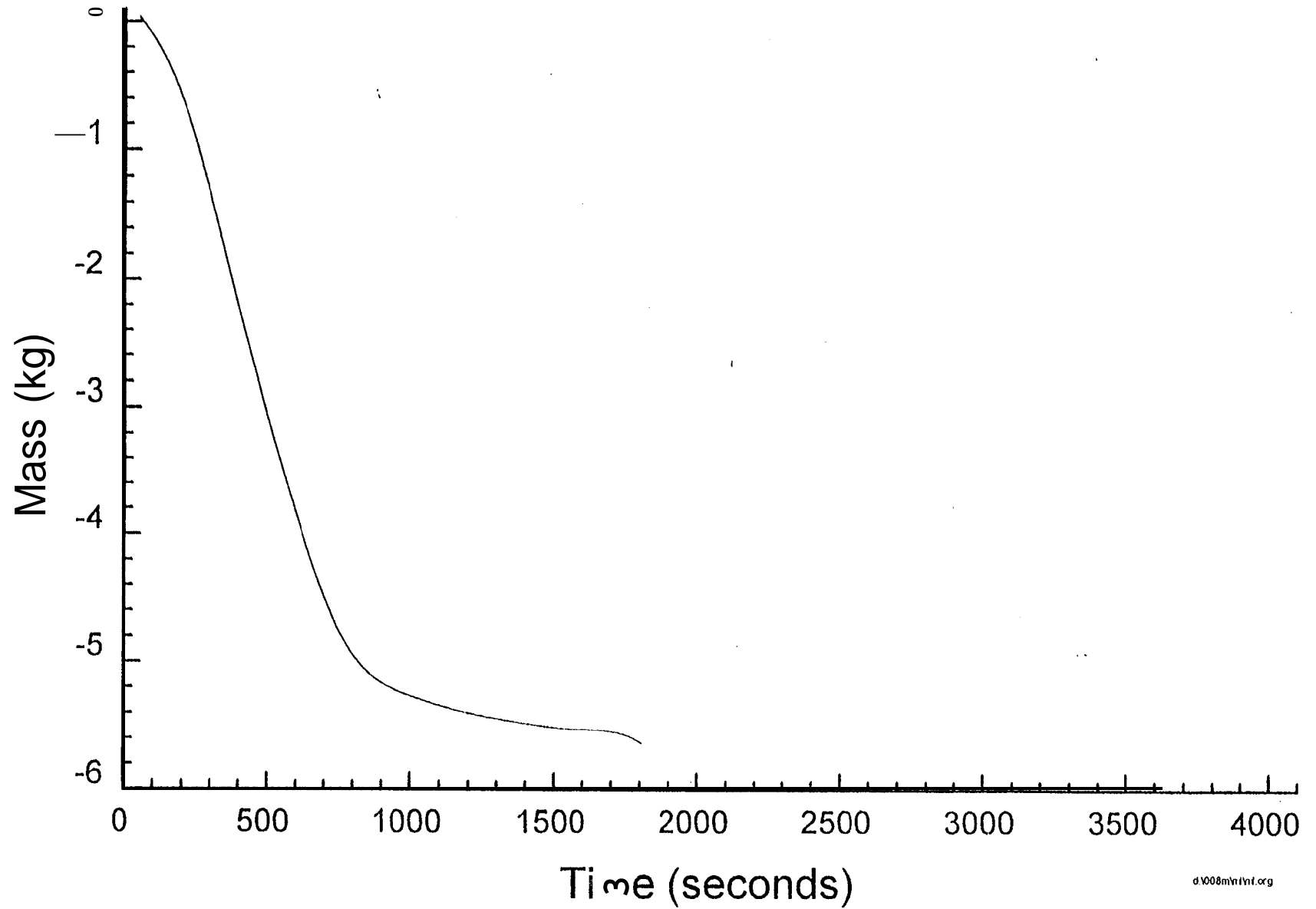

Fig. 7.3.1-5

Mass loss (Flaming fire in small room) - Test FMS8

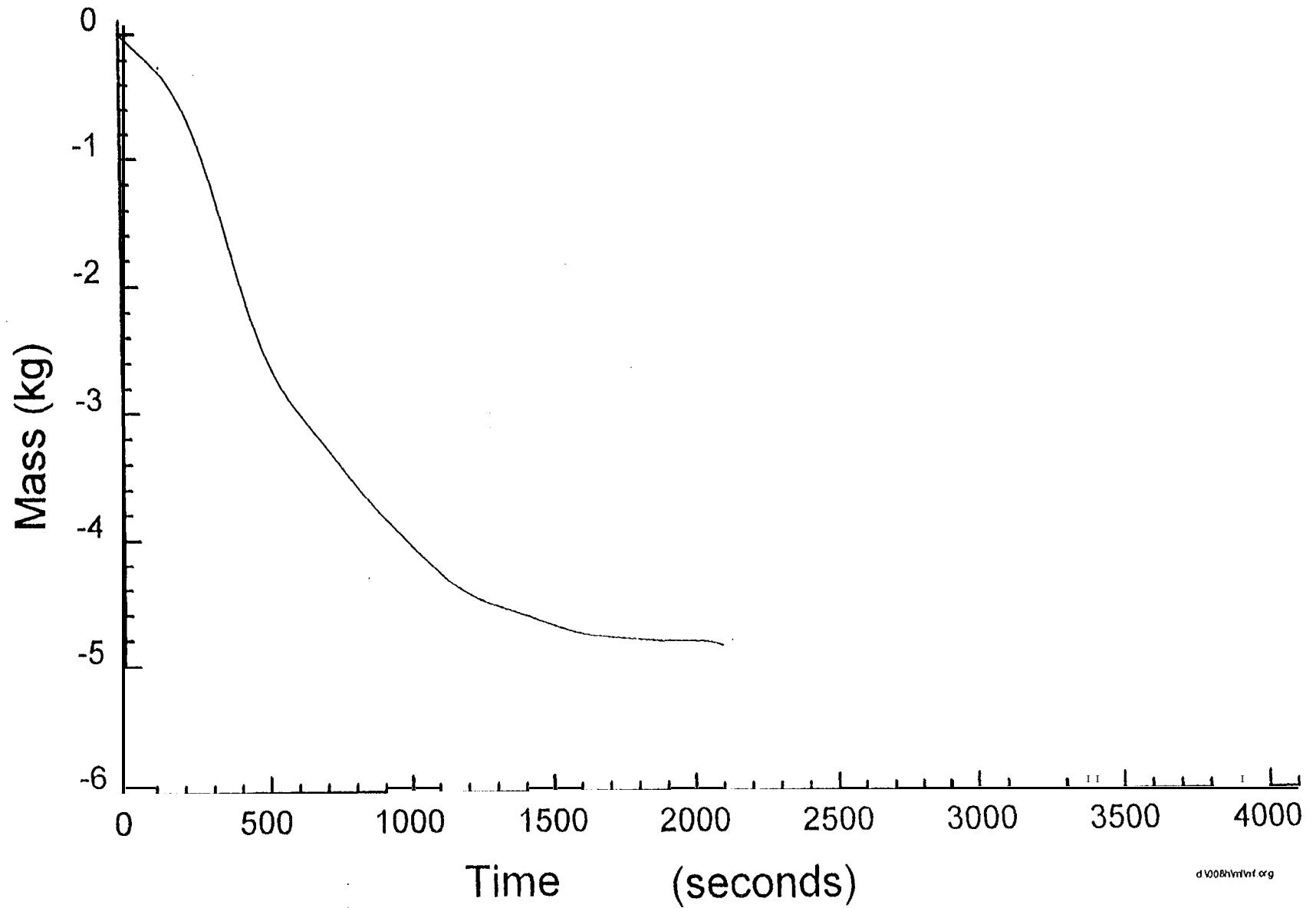

Fig. 7.3.1-6

Mass loss (Flaming fire in small room) - Test FMS10

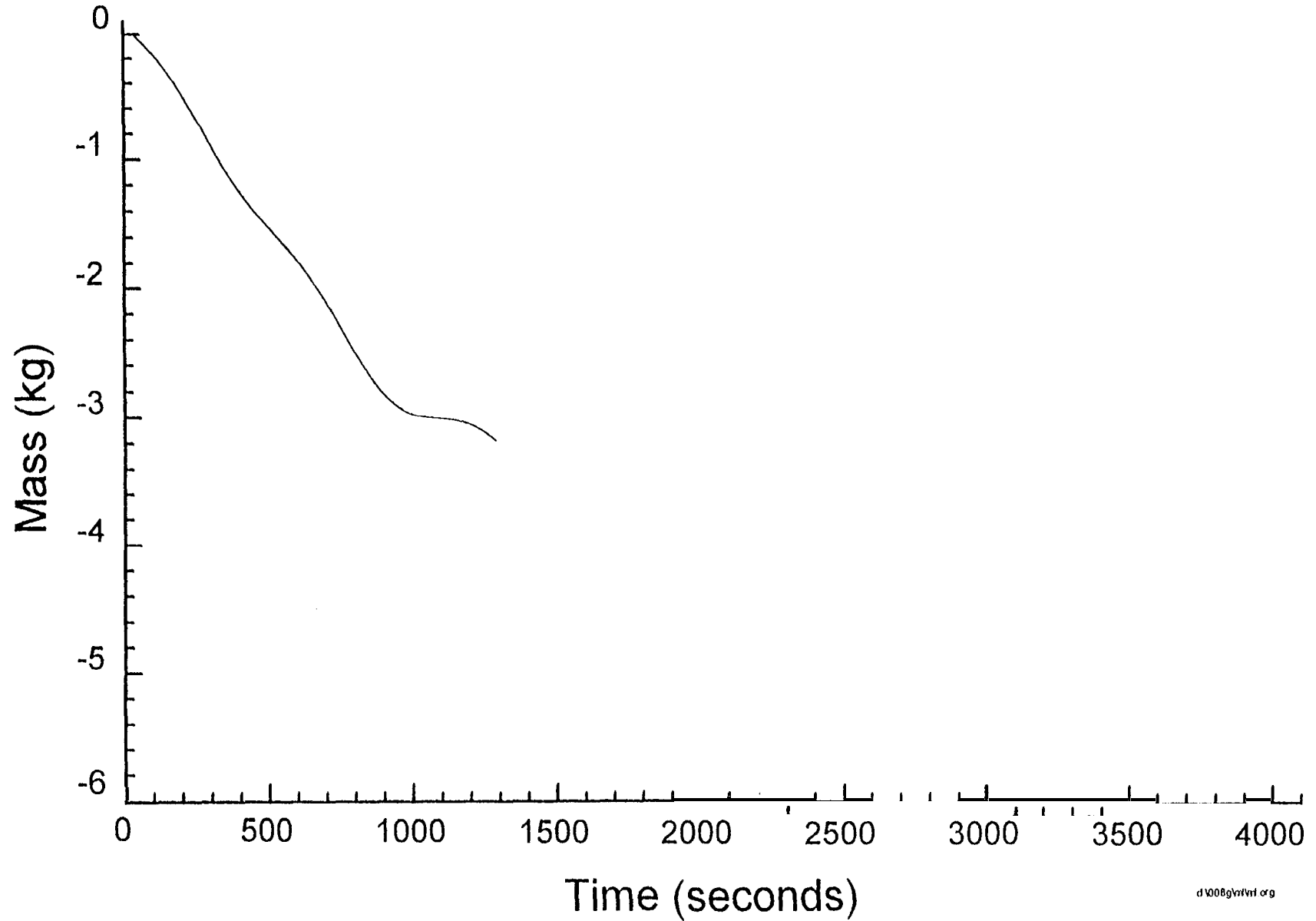

Fig. 7.3.2-1

Average room temperatures (Flaming fire in

- Test FMS4

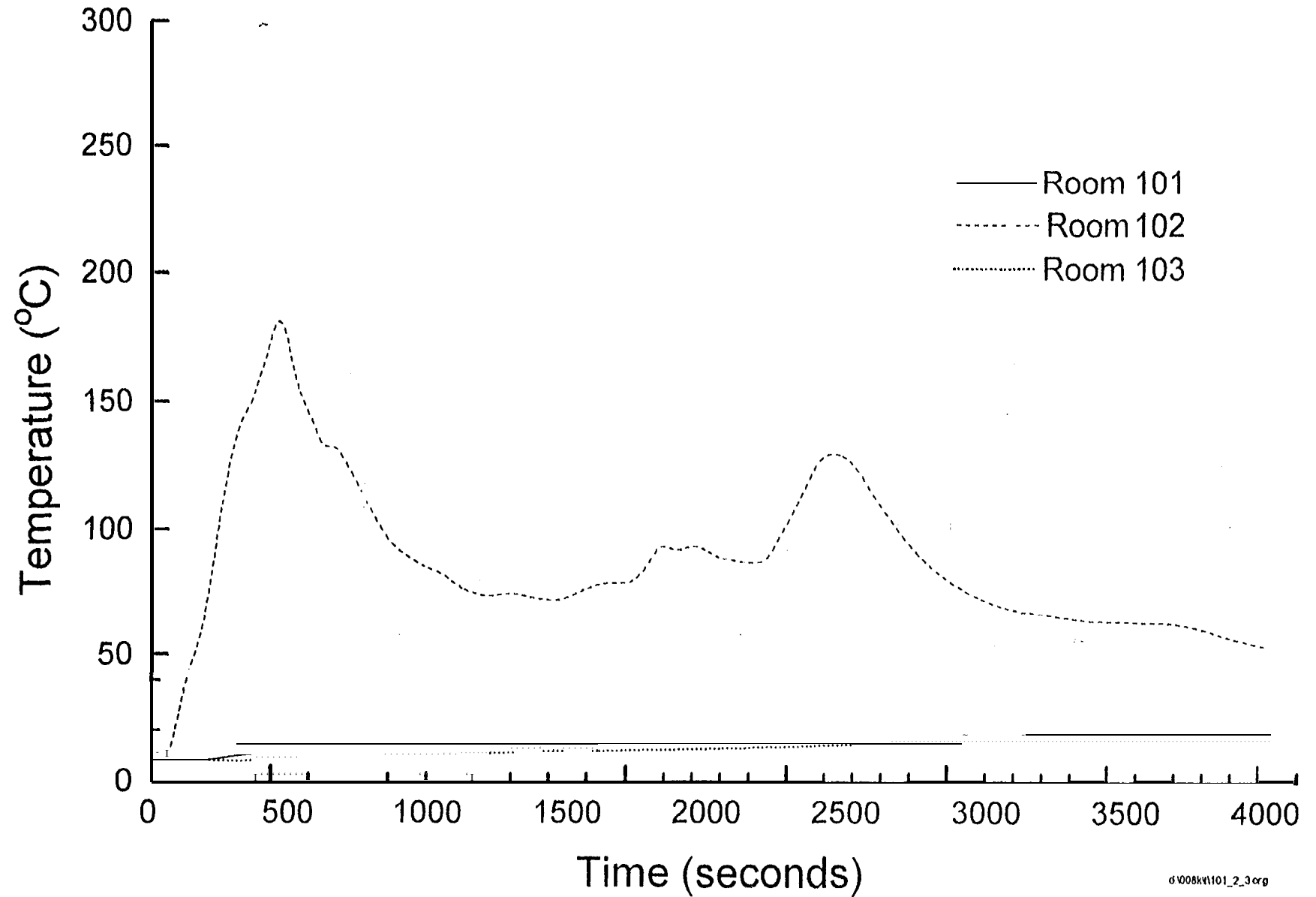

Fig. 7.3.2-2

Average room temperatures (Flaming fire in small room) - Test FMS5

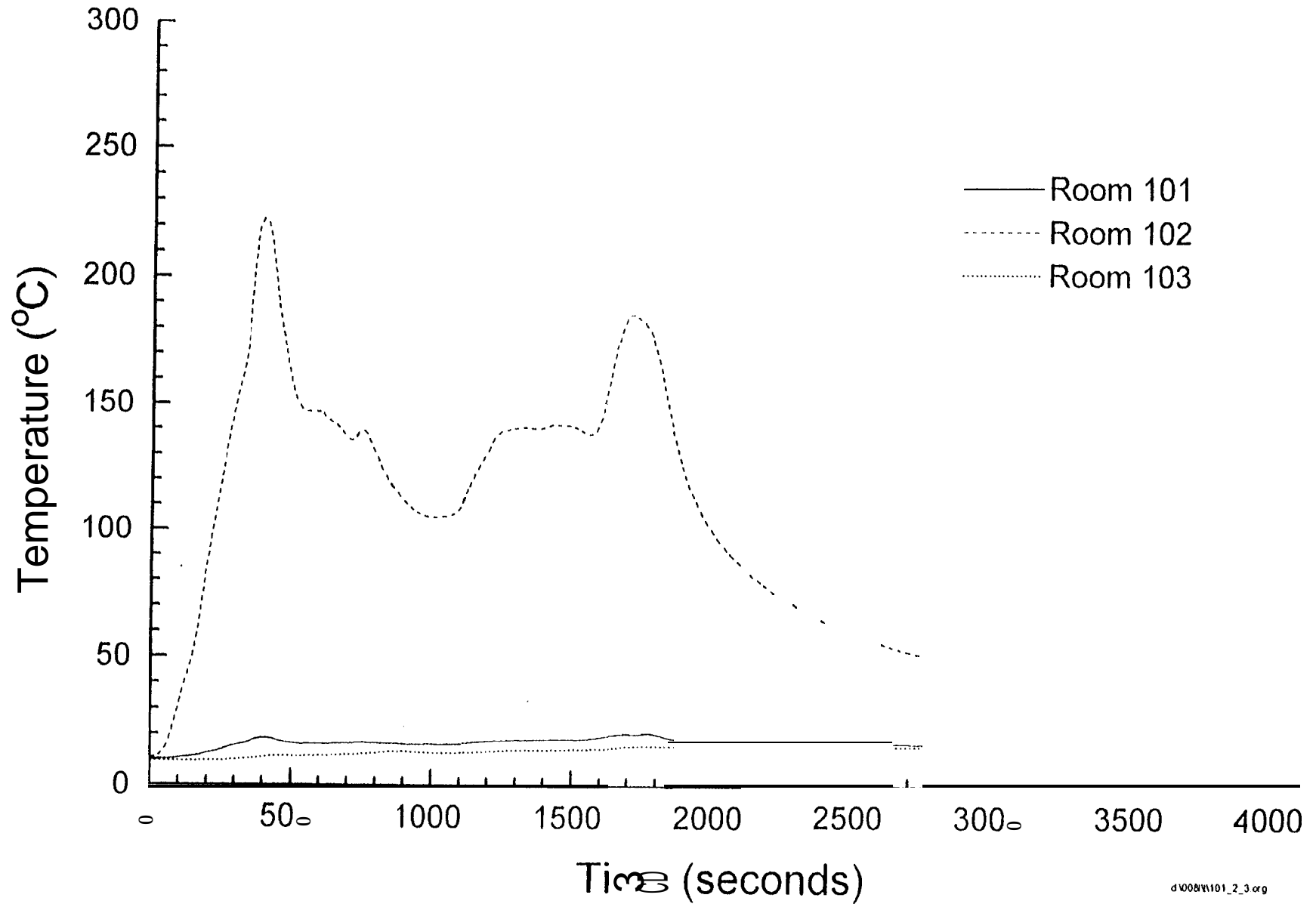

Fig. 7.3.2-3

Average room temperatures (Flaming fire in small room) - Test FMS6

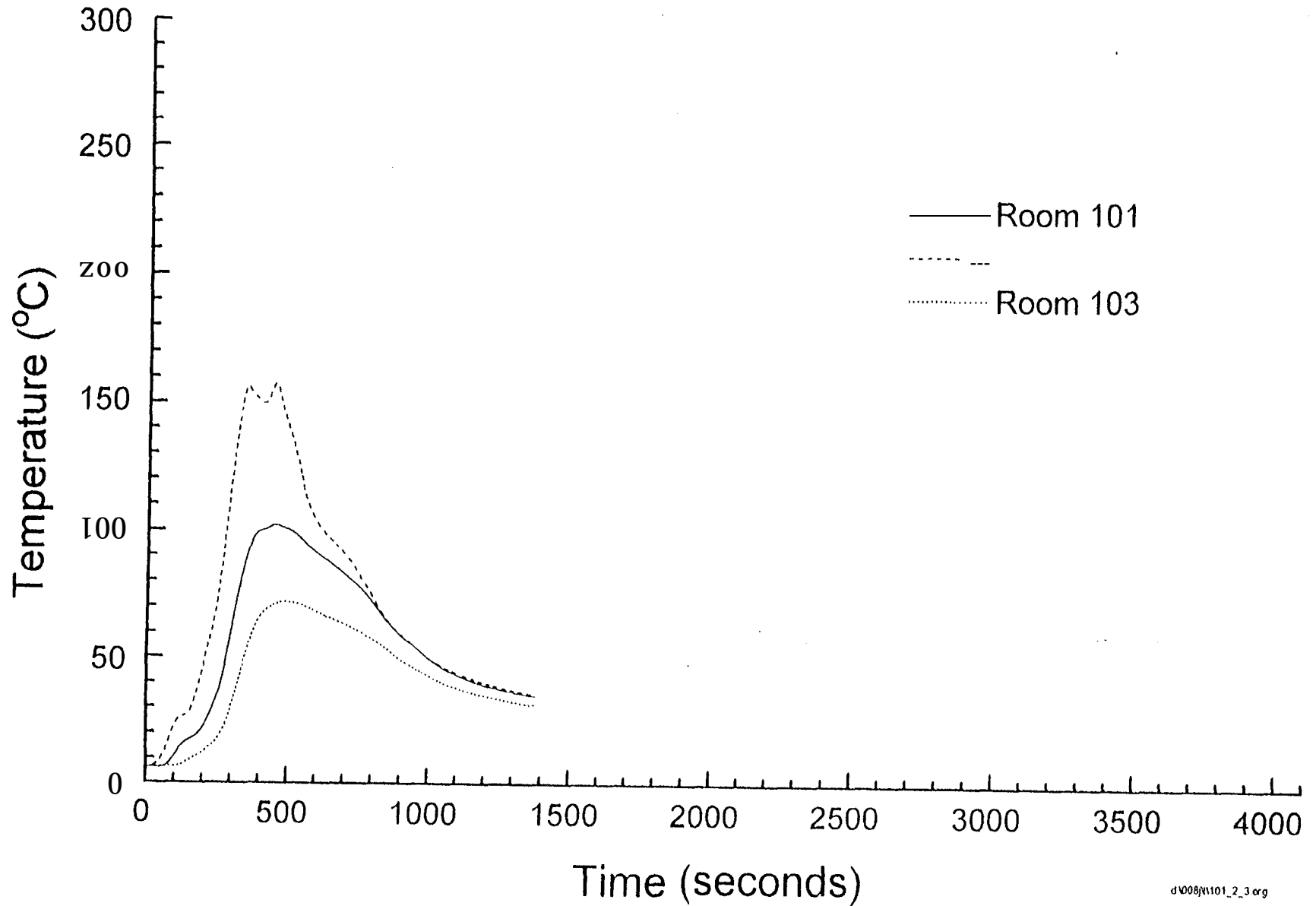

Fig. 7.3.2-4

Average room temperatures (Flaming fire in small room) - Test FMS7

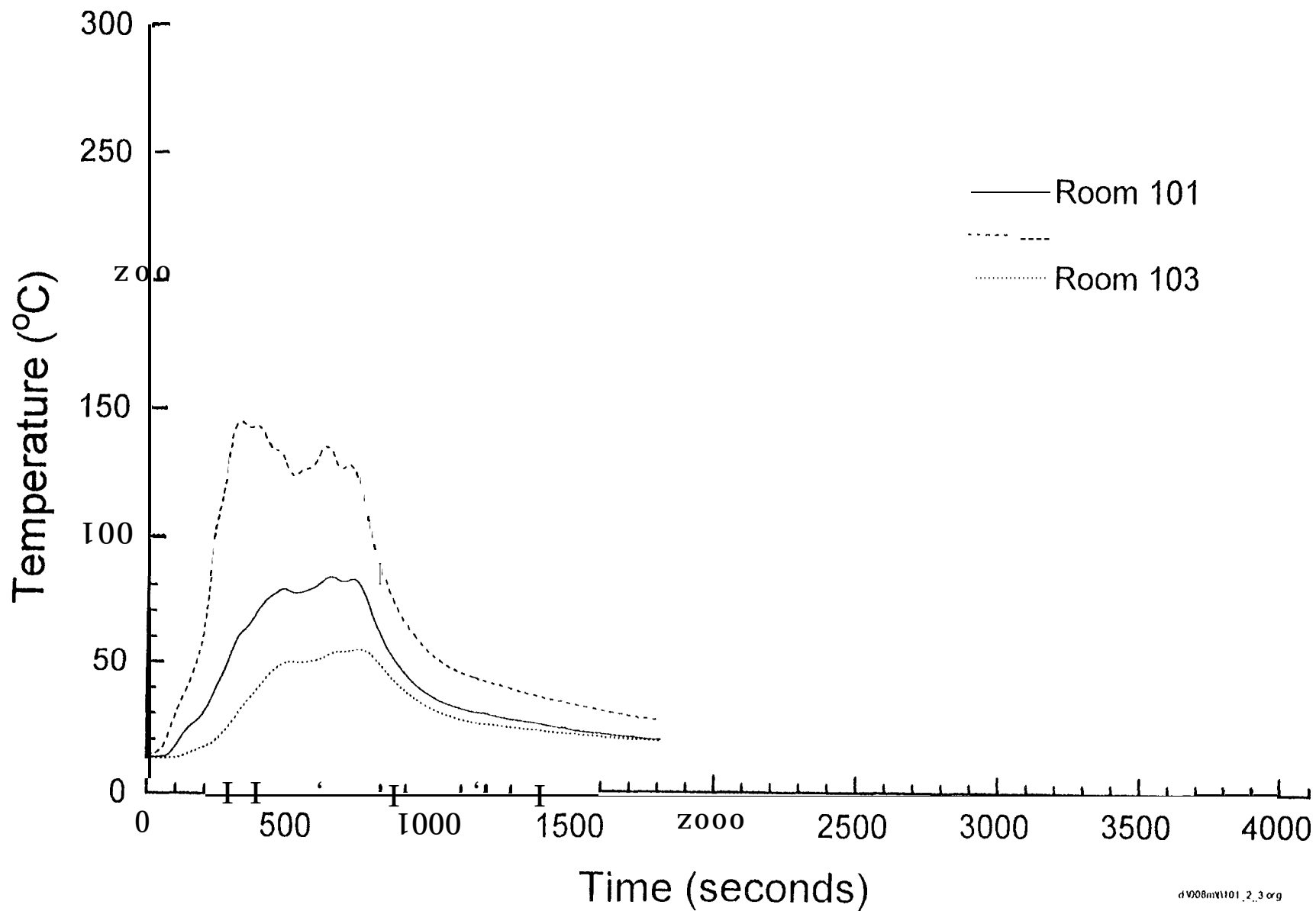

Fig. 7.3.2-5

Average room

fire in small room) - Test FMS8

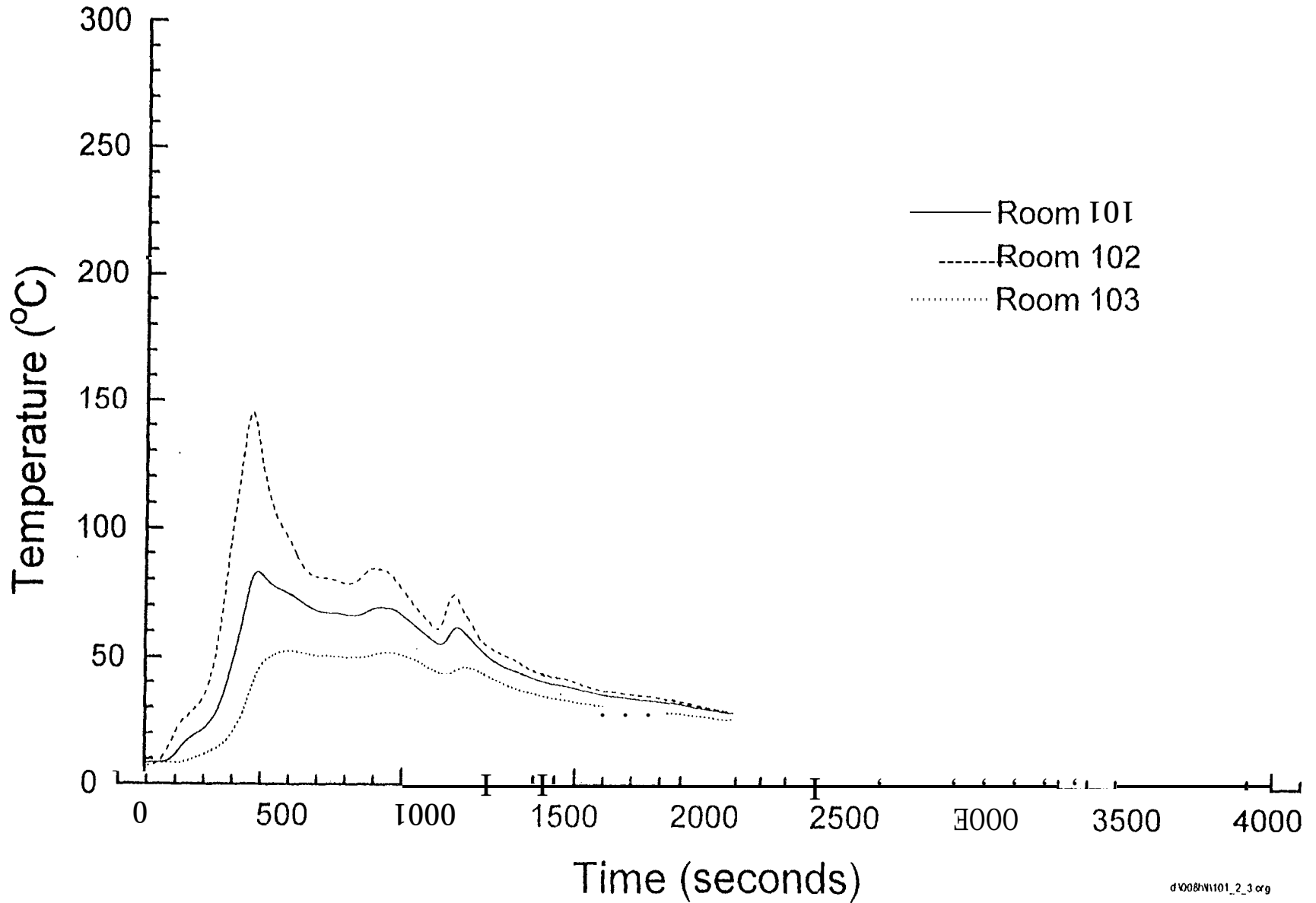

Fig. 7.3.2-6

Average room temperatures (Flaming fire in small room) - Test FMS10

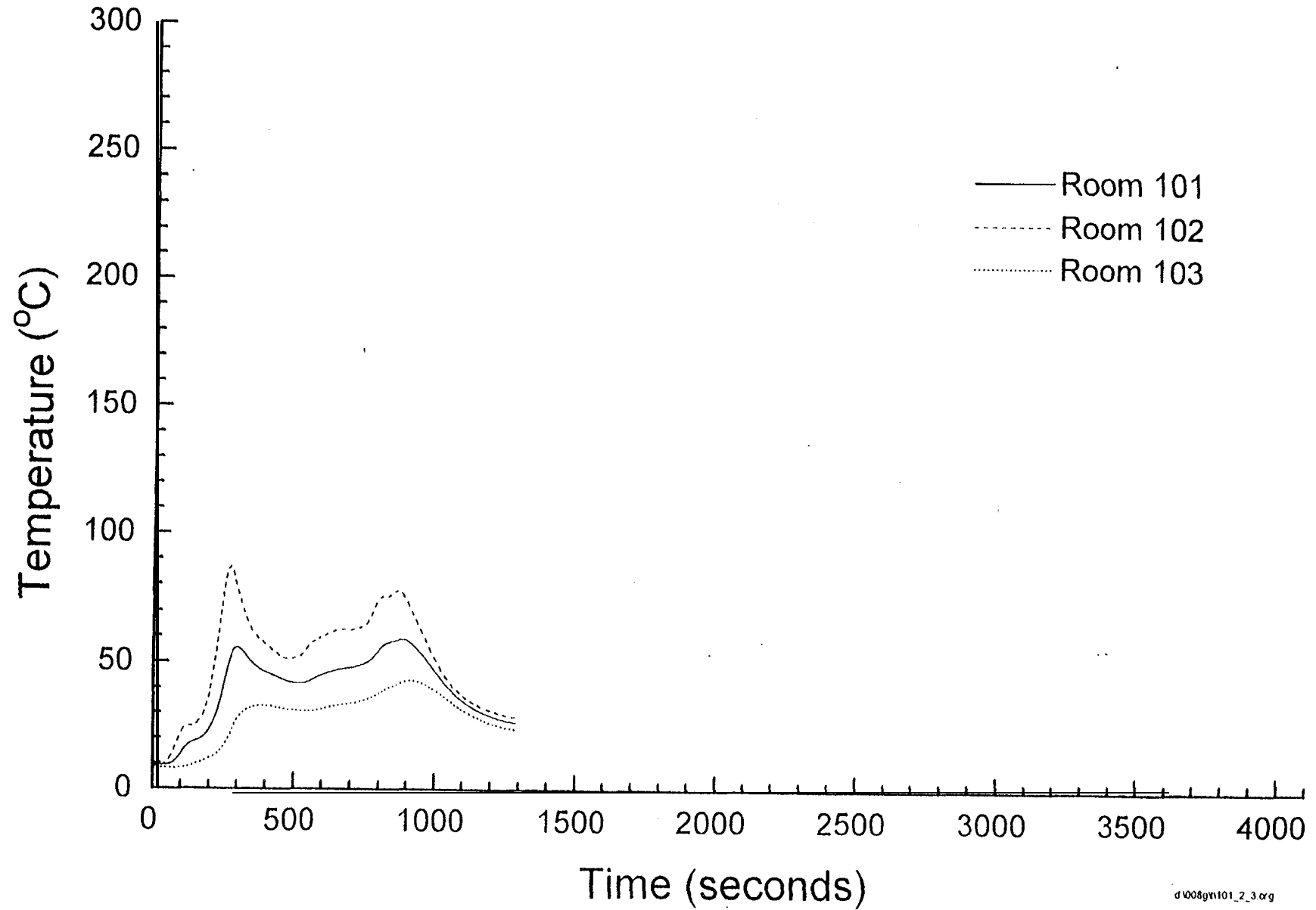

Fig. 7.3.3-1

Temperatures along corridor (Flaming fire in small room) - Test FMS4

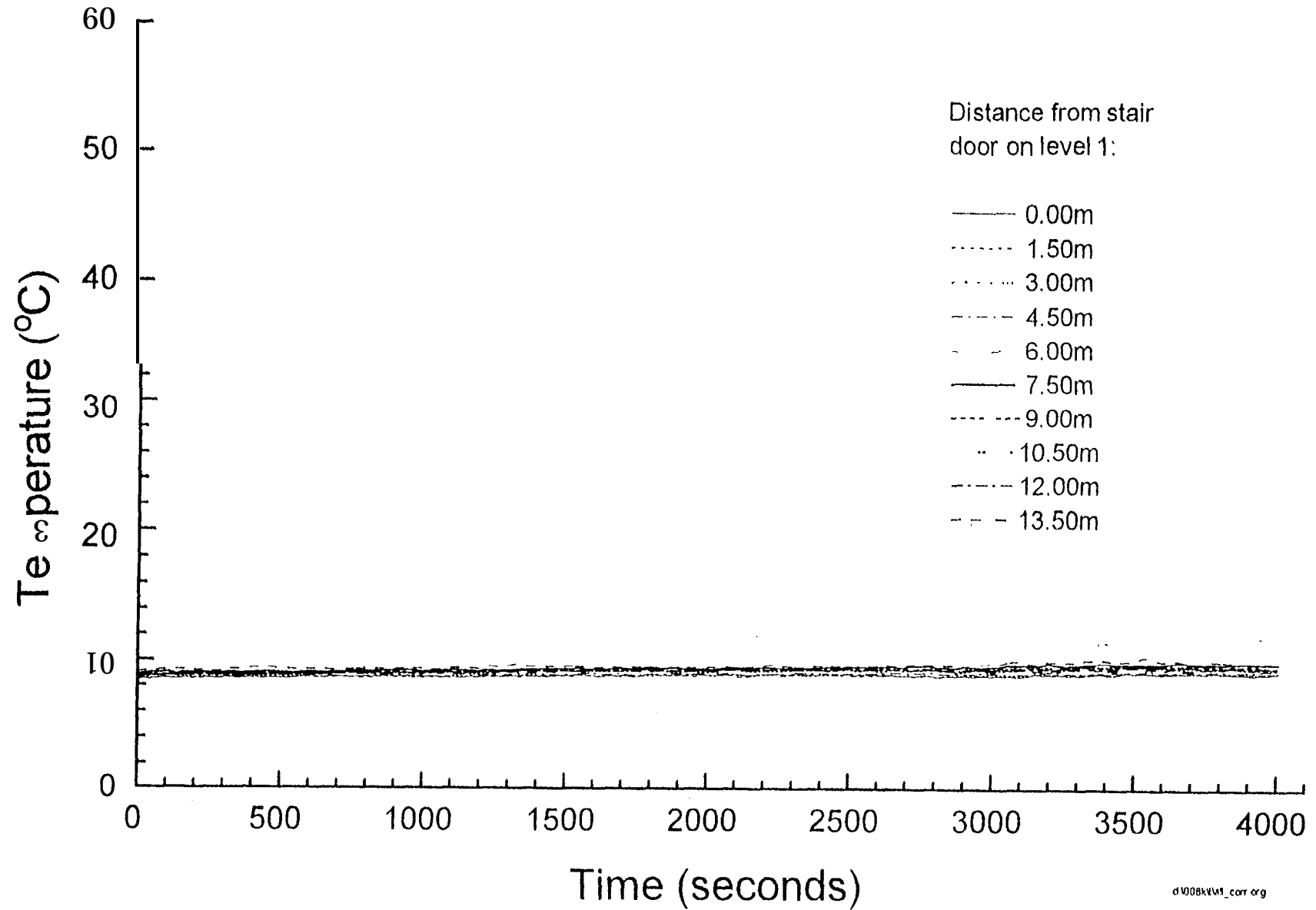

Fig. 7.3.3-2

Temperatures along corridor (Flaming fire in small room) - Test FMS5

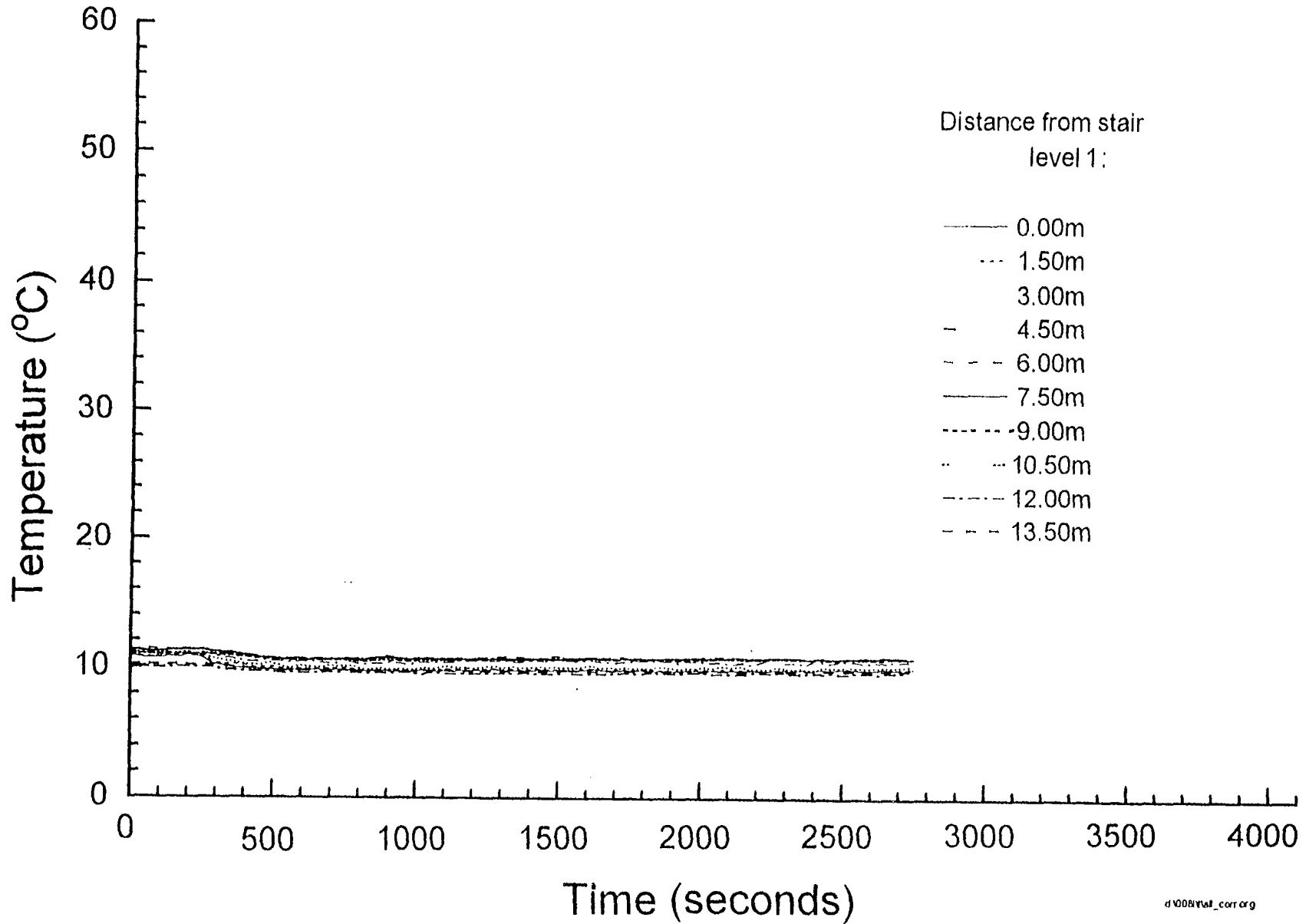
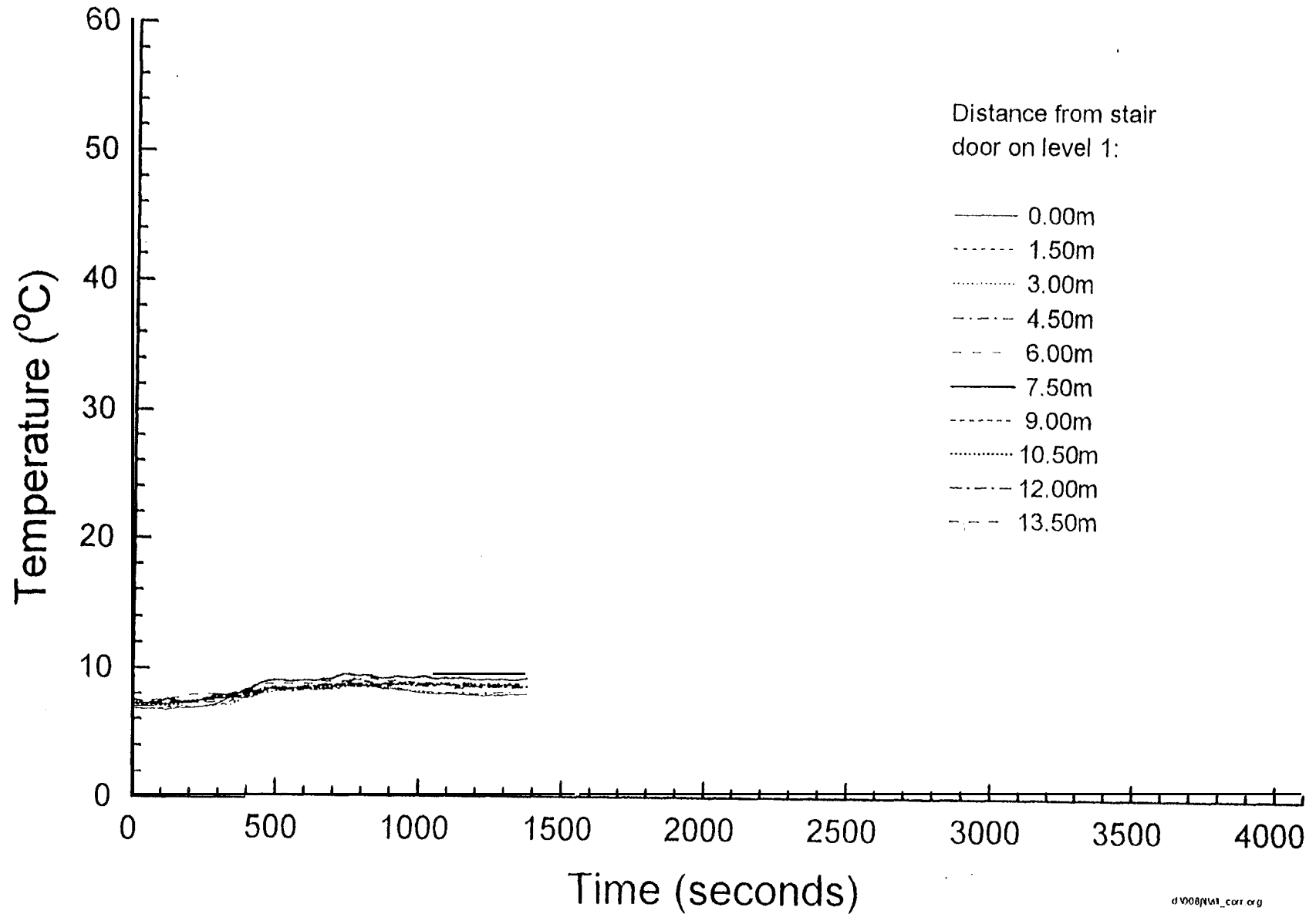

Fig. 7.3.3-3

Temperatures along corridor (Flaming fire in small room) - Test FMS6



Fig

7.3.3-4 (Flaming fire in small room) - Test FMS7

Temperatures

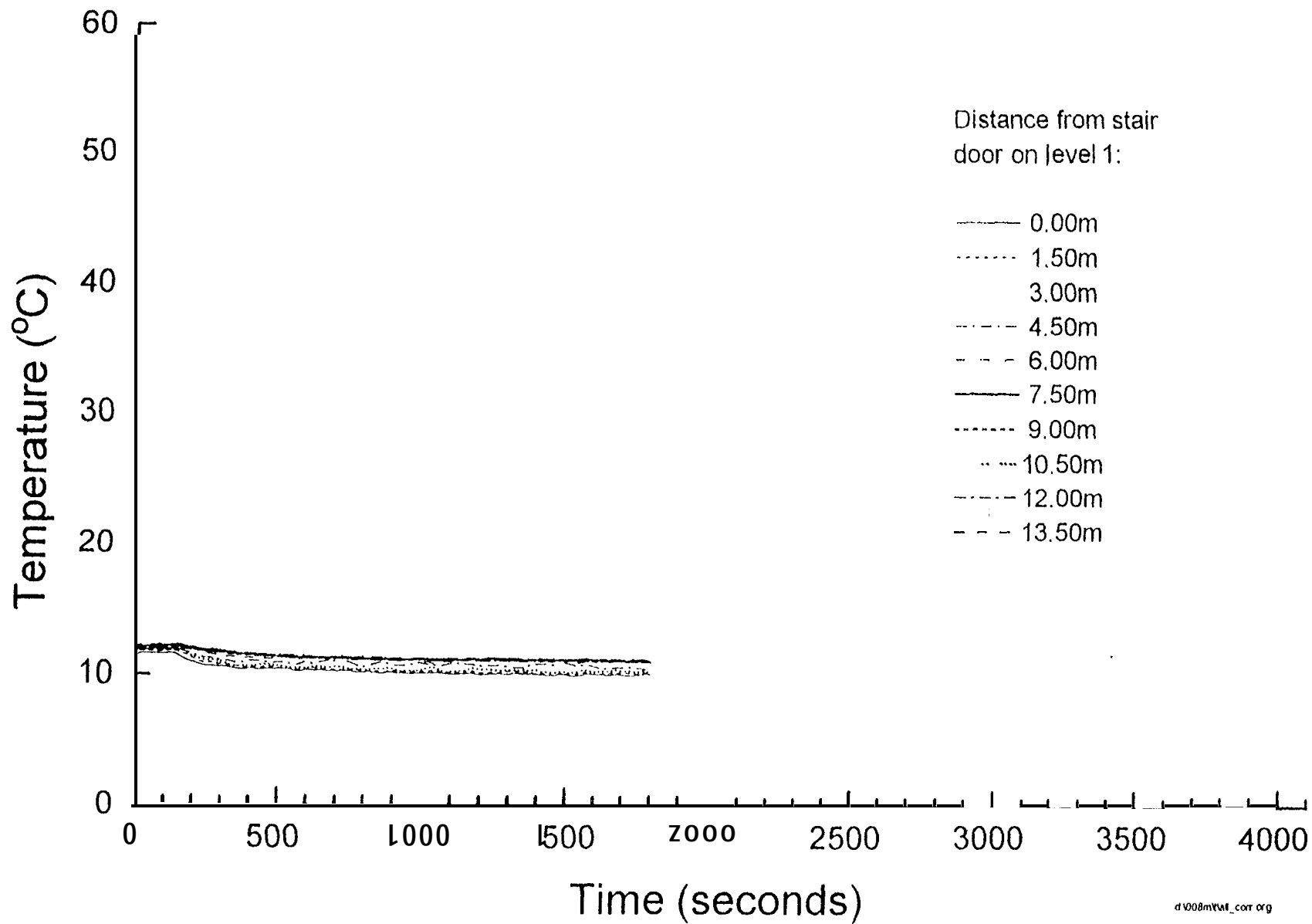

Fig. 7.3.3-5

Temperatures along corridor (Flaming fire in small room) - Test FMS8

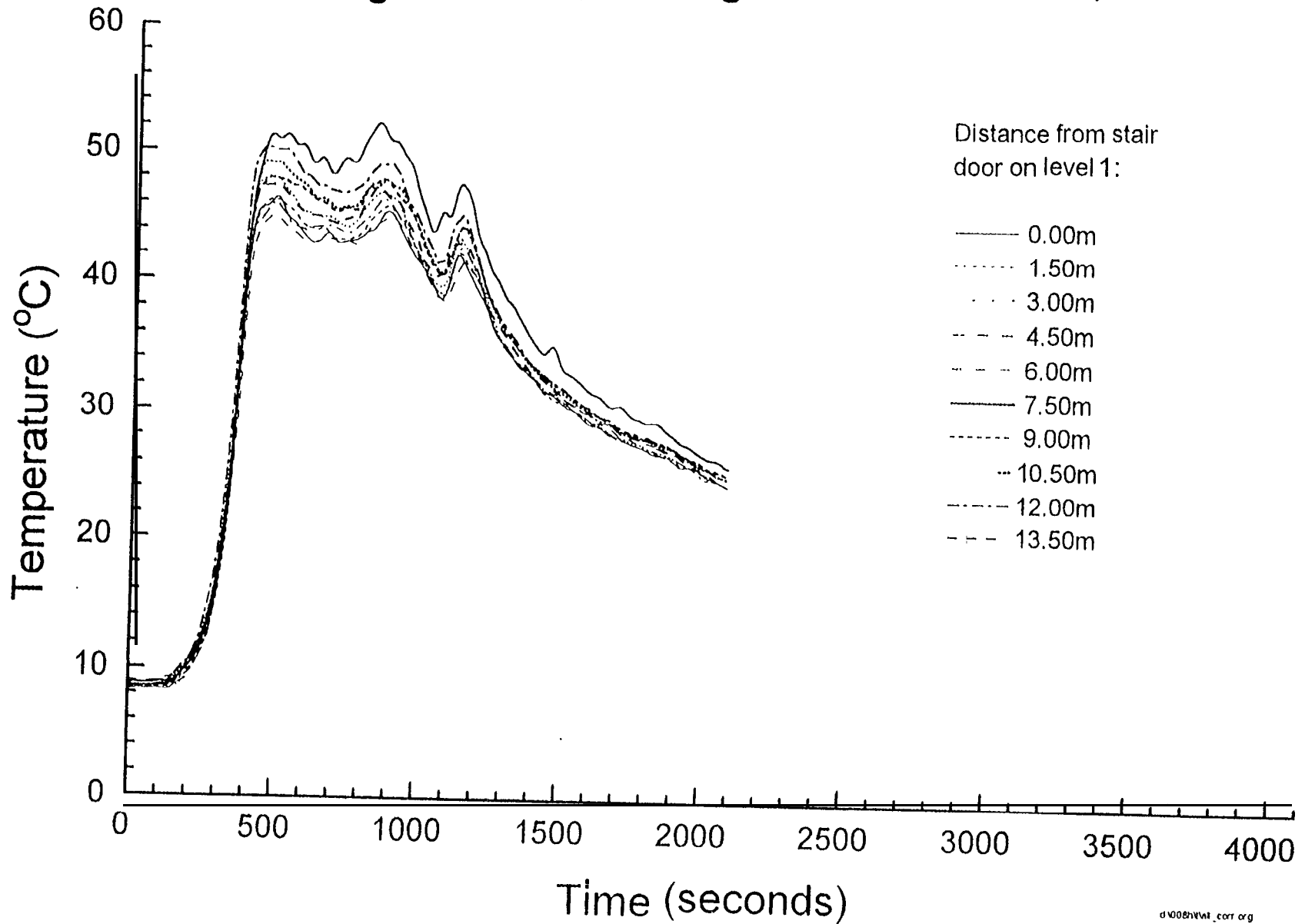

Fig. 7.3.3-6

Temperatures along corridor (Flaming fire in small room) - Test FMS10

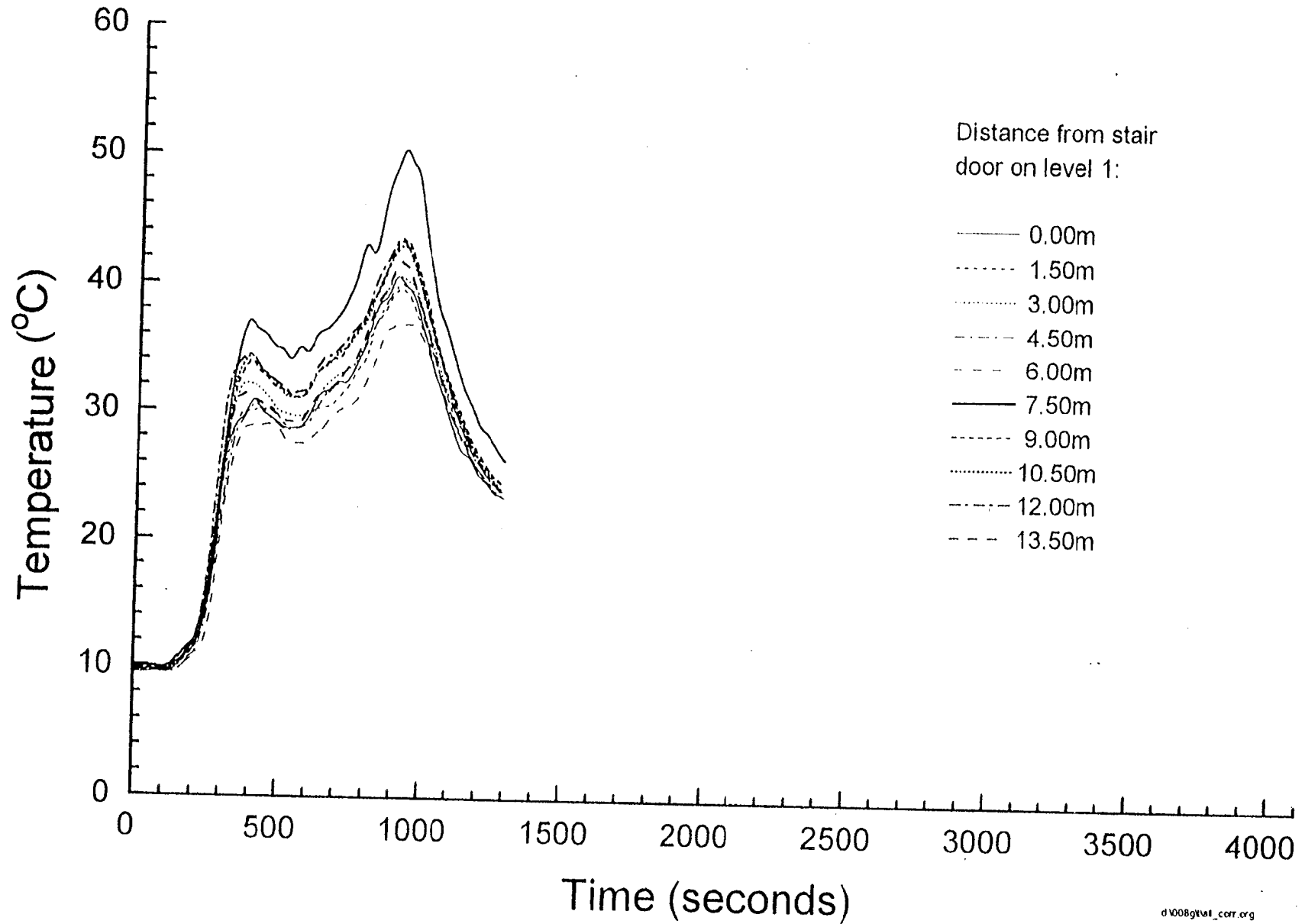

Fig. 7.3.4-1

Radiative heat flux (Flaming fire in small room) - Test FMS4

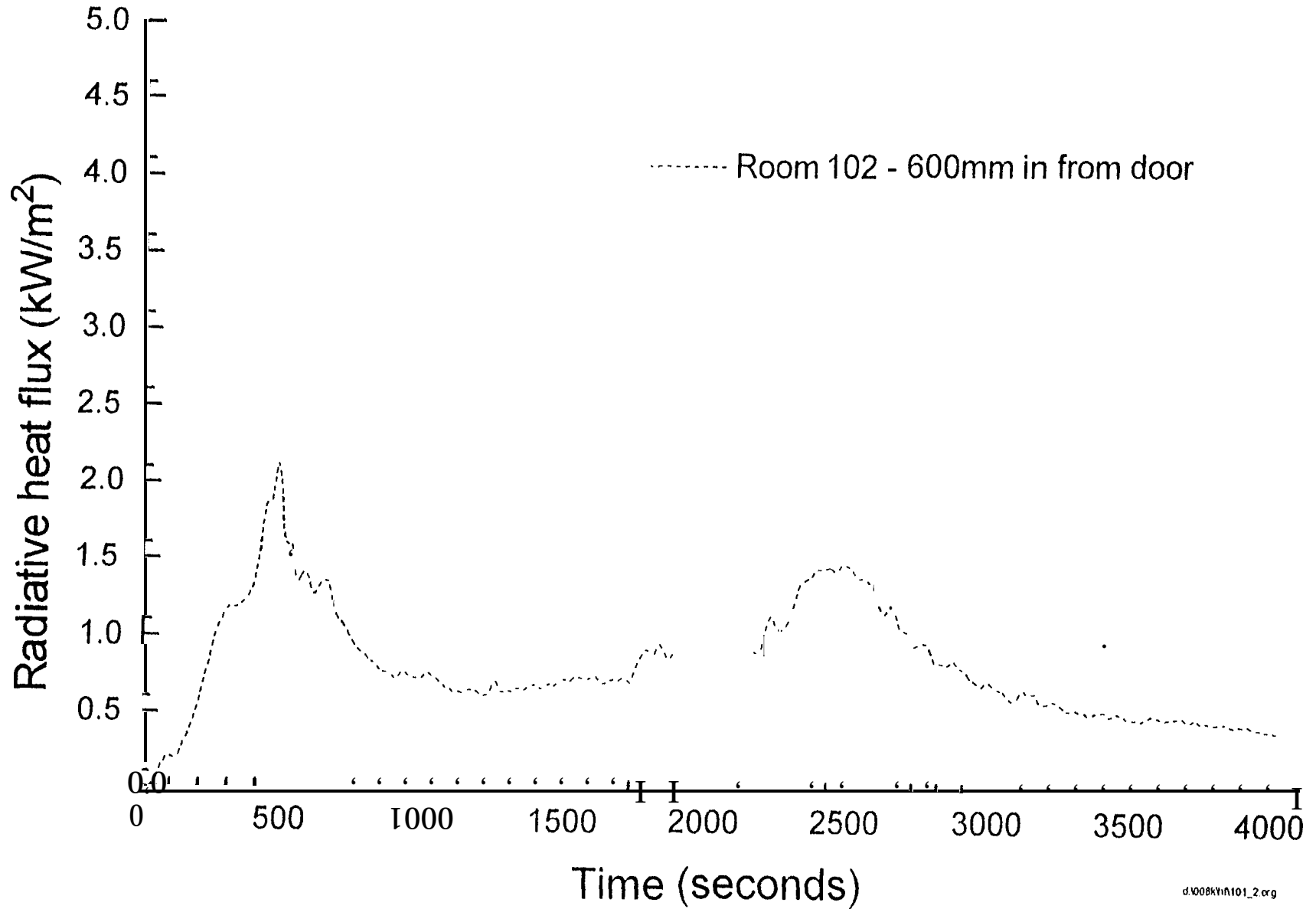

Fig. 7.3.4-2

Radiative heat flux (Flaming fire in small room) - Test FMS5

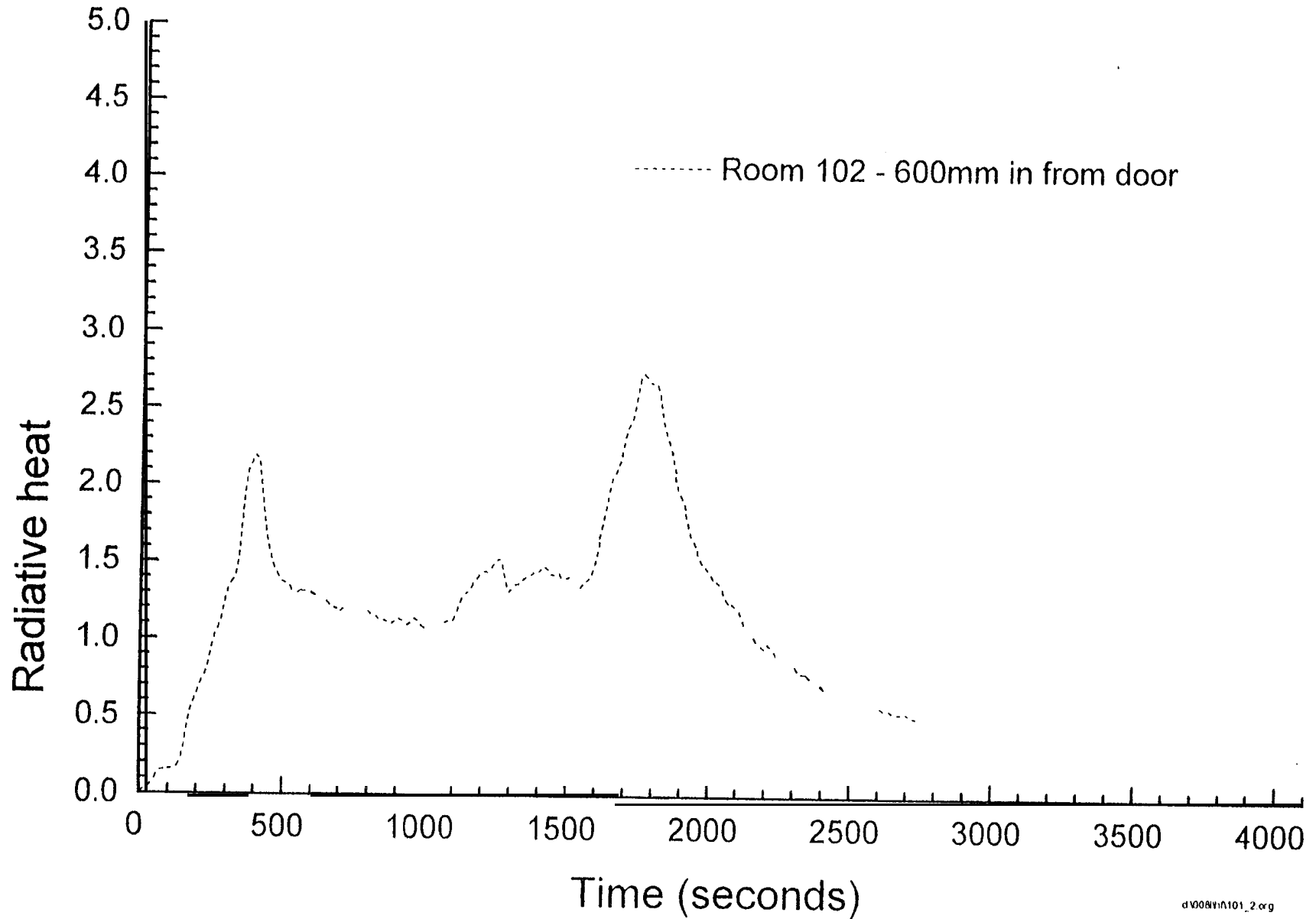

Fig. 7.3.4-3

Radiative heat flux (Flaming fire in small room) - Test FMS6

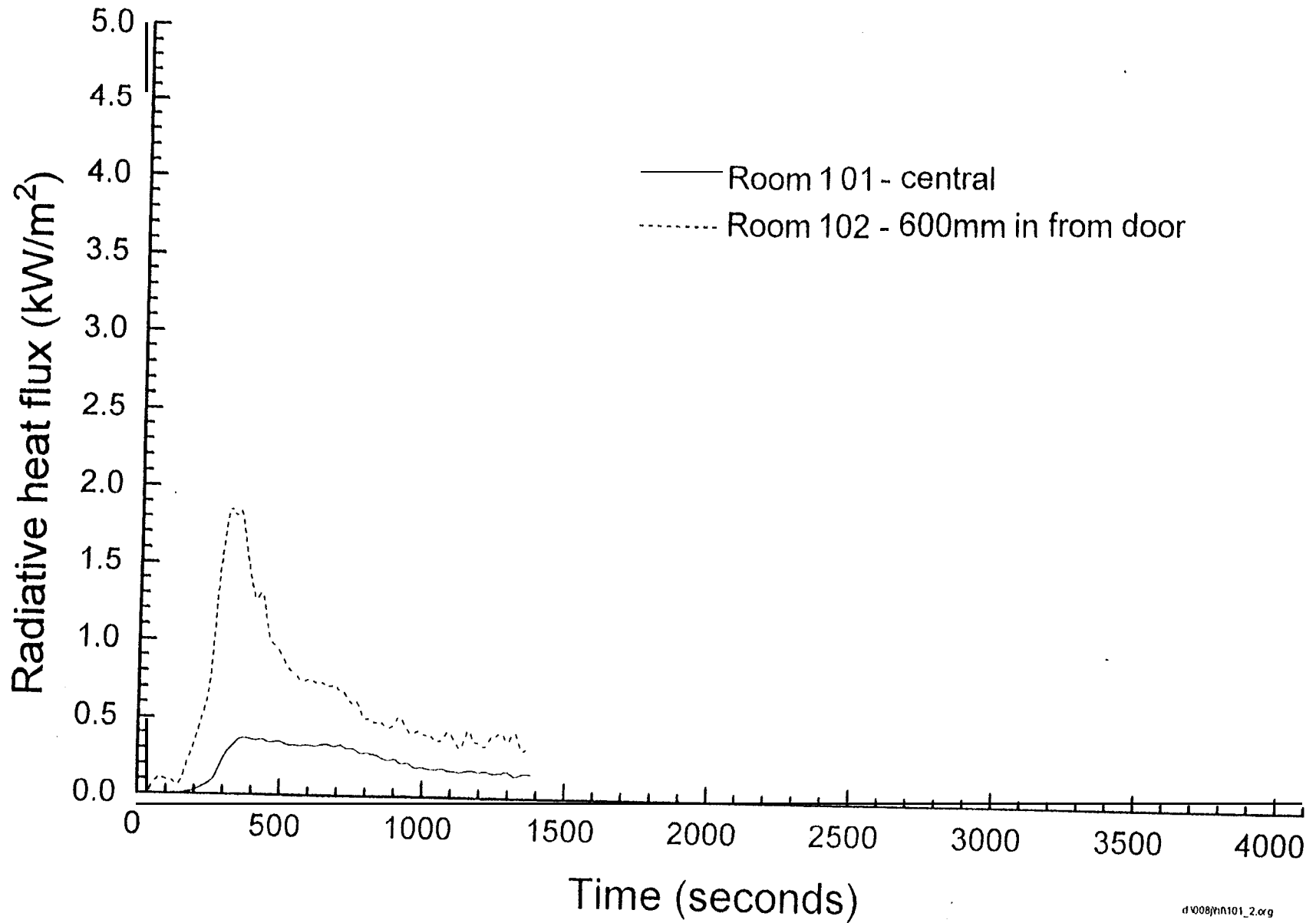

Fig. 7.3.4-4

Radiative heat flux (Flaming fire in small room) - Test FMS7

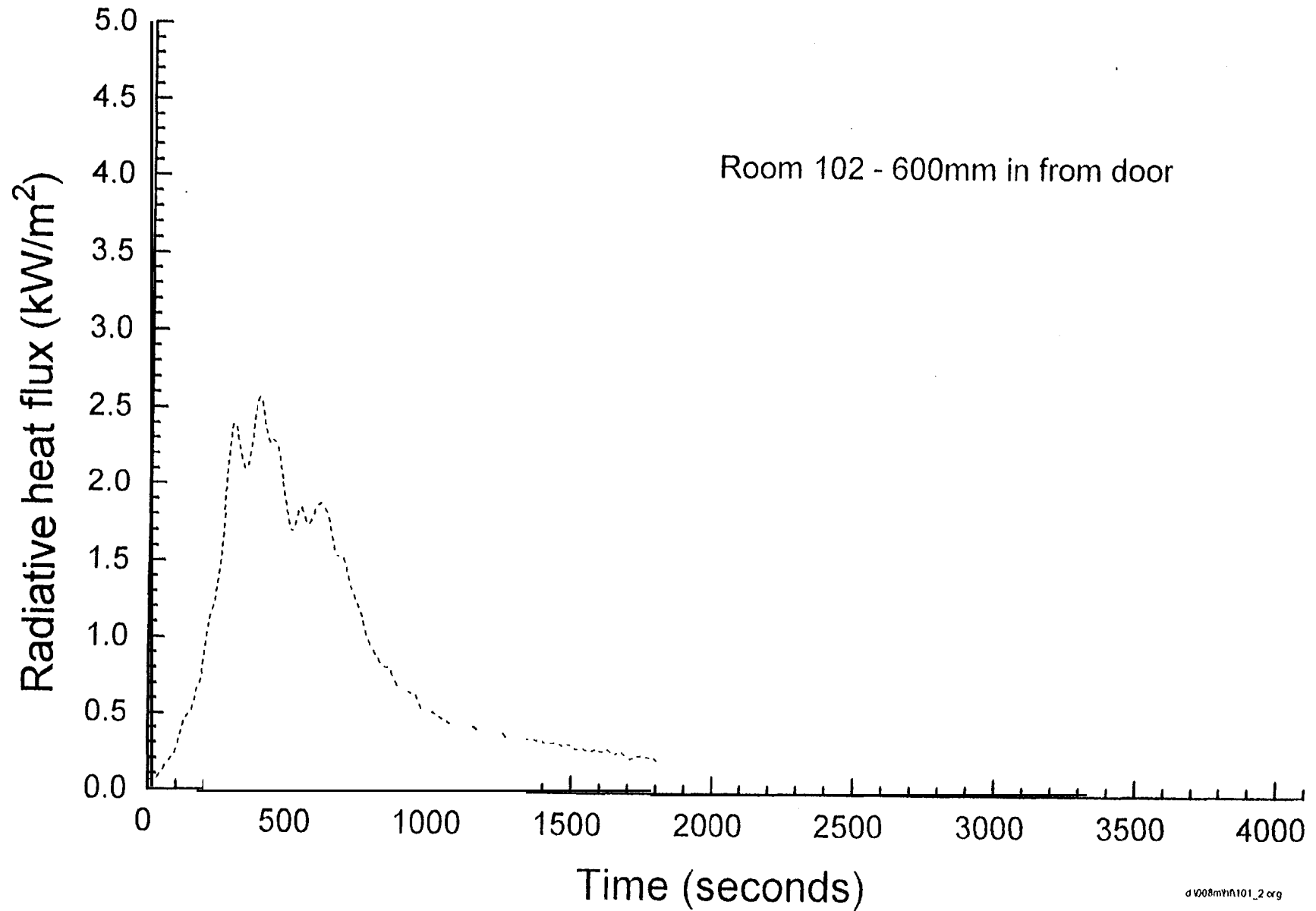

Fig. 7.3.4-5
flux (Flaming fire in small room) - Test FMS8

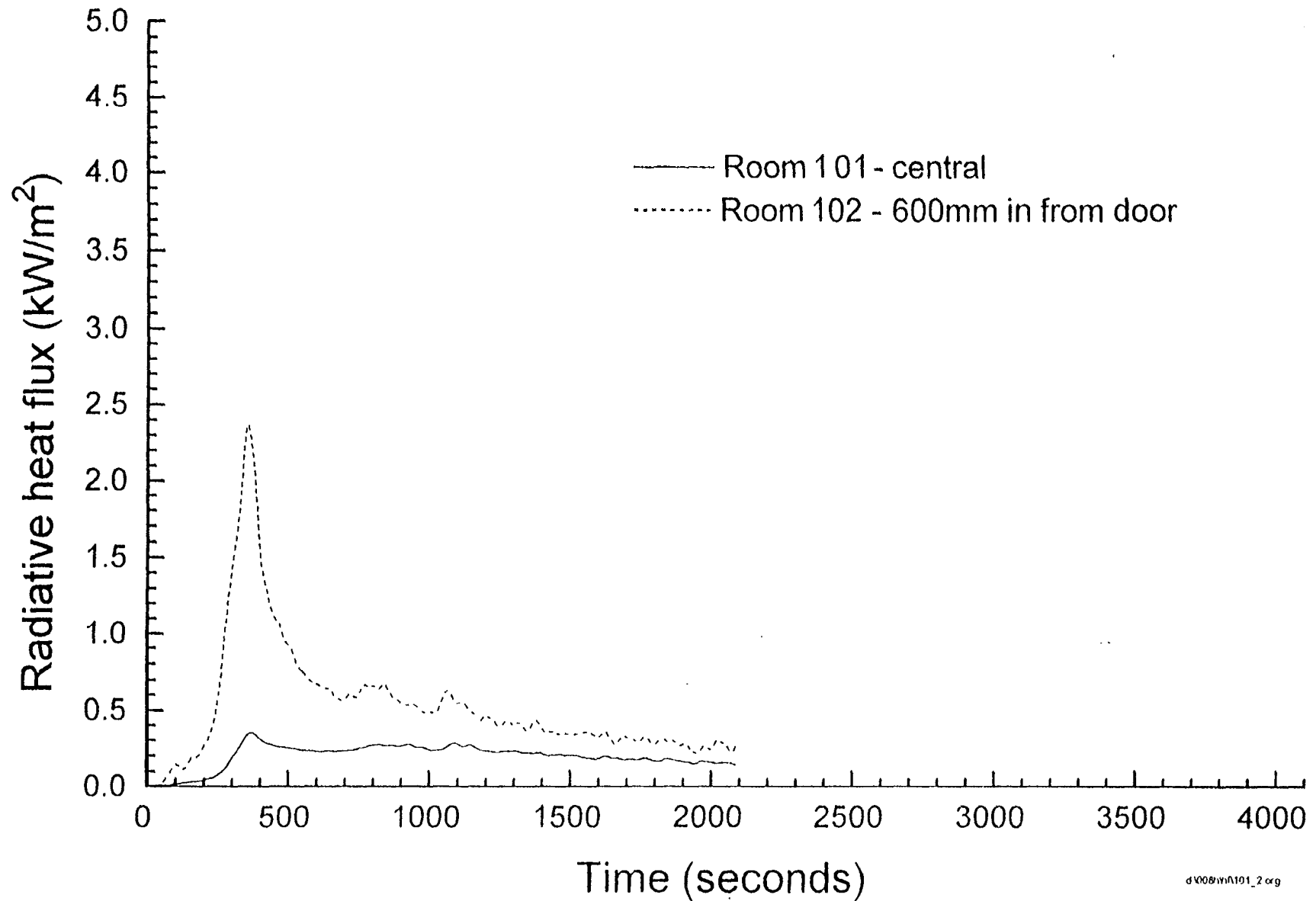

Fig. 7.3.4-6

Radiative heat flux (Flaming fire in small room) - Test FMS10

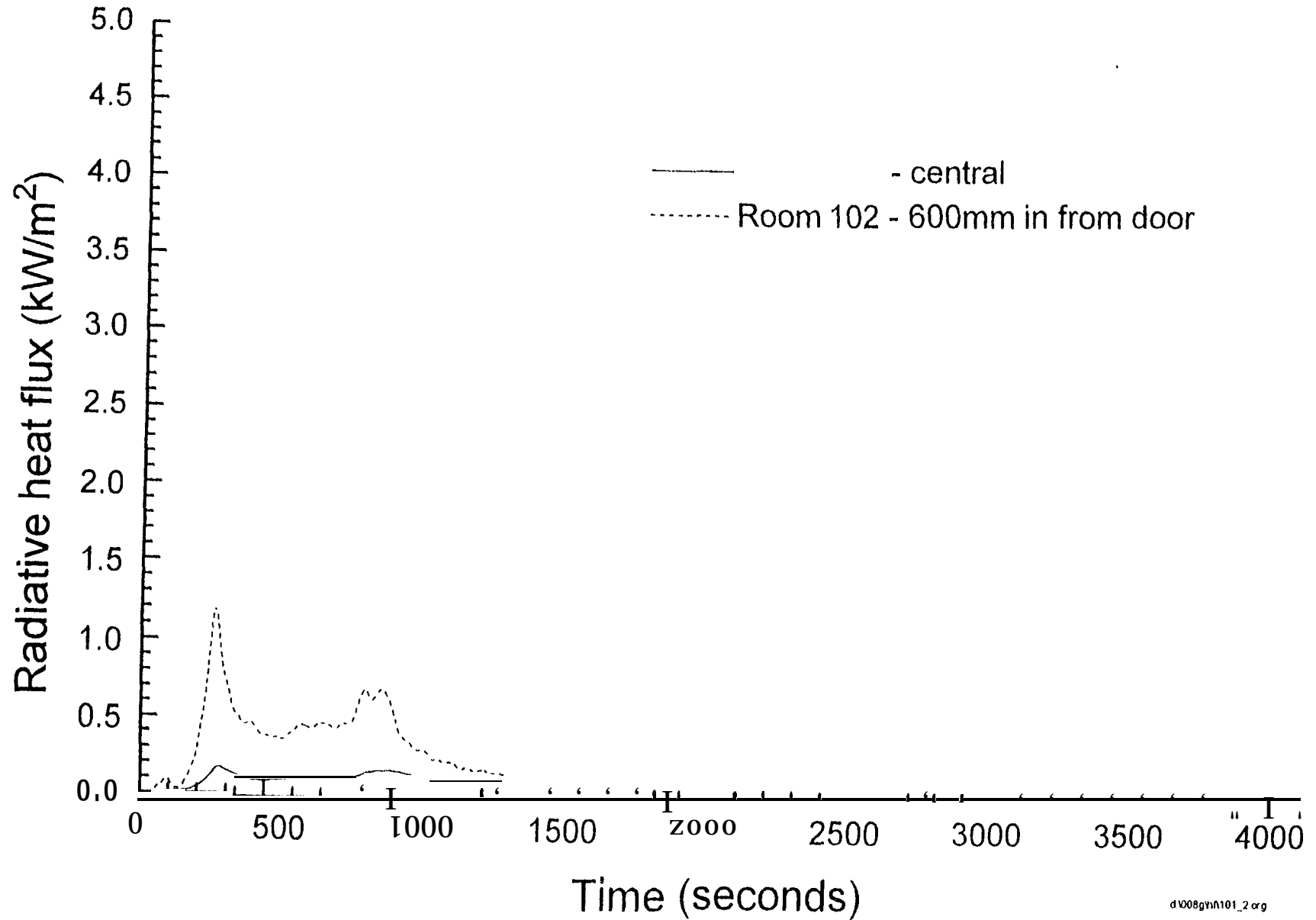

Fig. 7.3.5-1

Carbon monoxide concentration (Flaming fire in small room) - Test FMS4

At 1900mm high in doorways

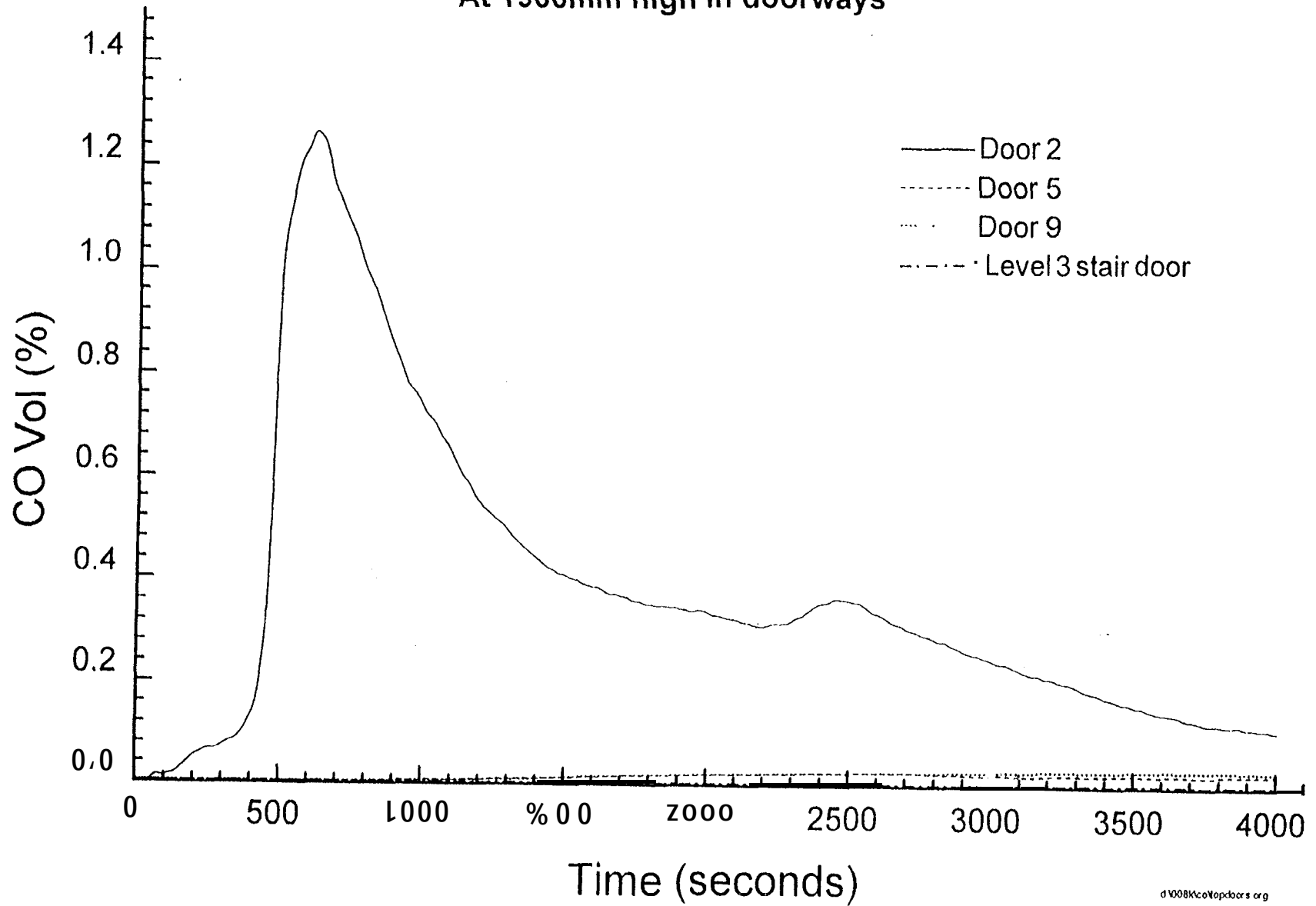
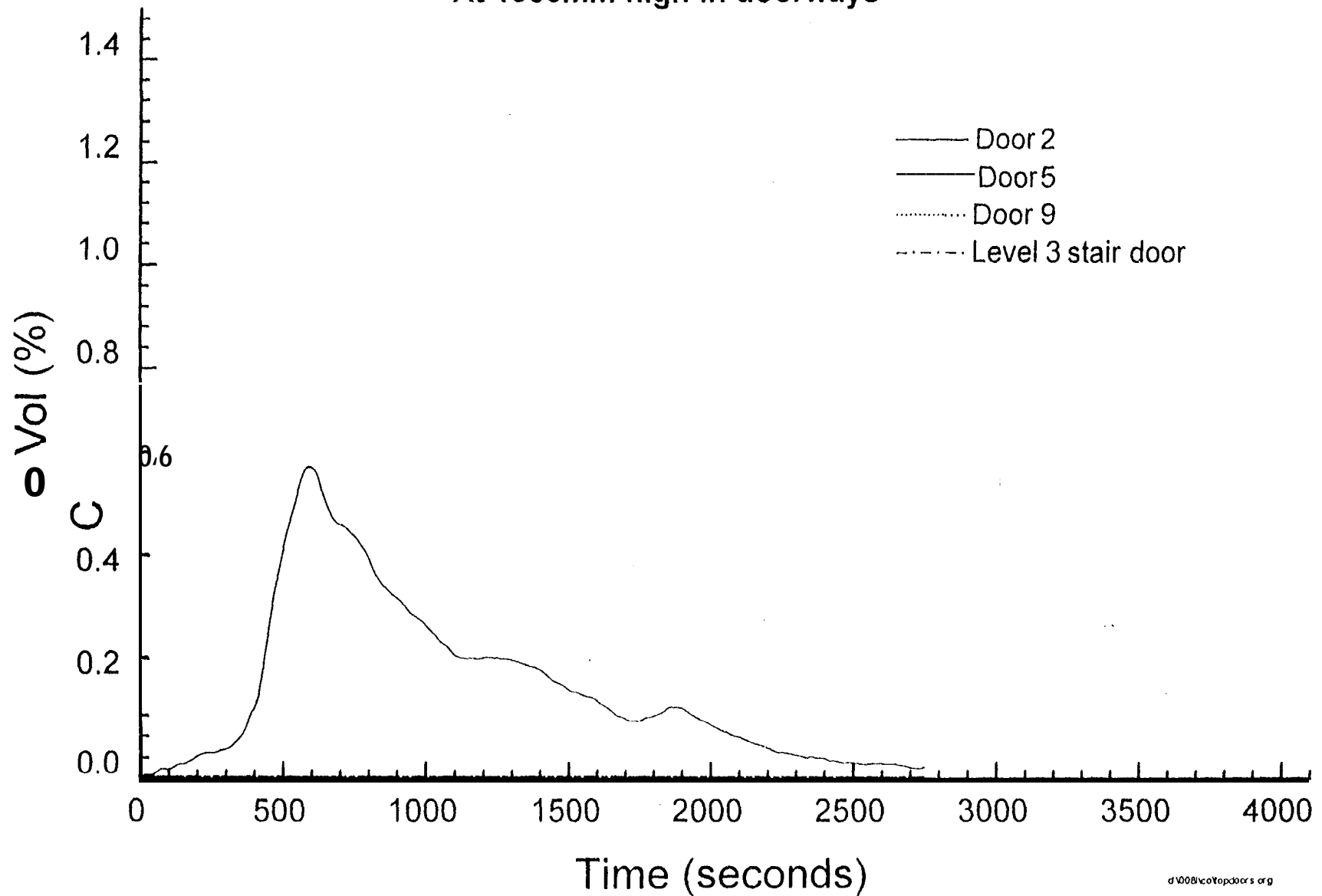

Fig. 7.3.5-2

Carbon monoxide

fire in small room) - Test FMS5

At 1900mm high in doorways



concentration (Flaming fire in small room) - Test FMS6

At 1900mm high in doorways

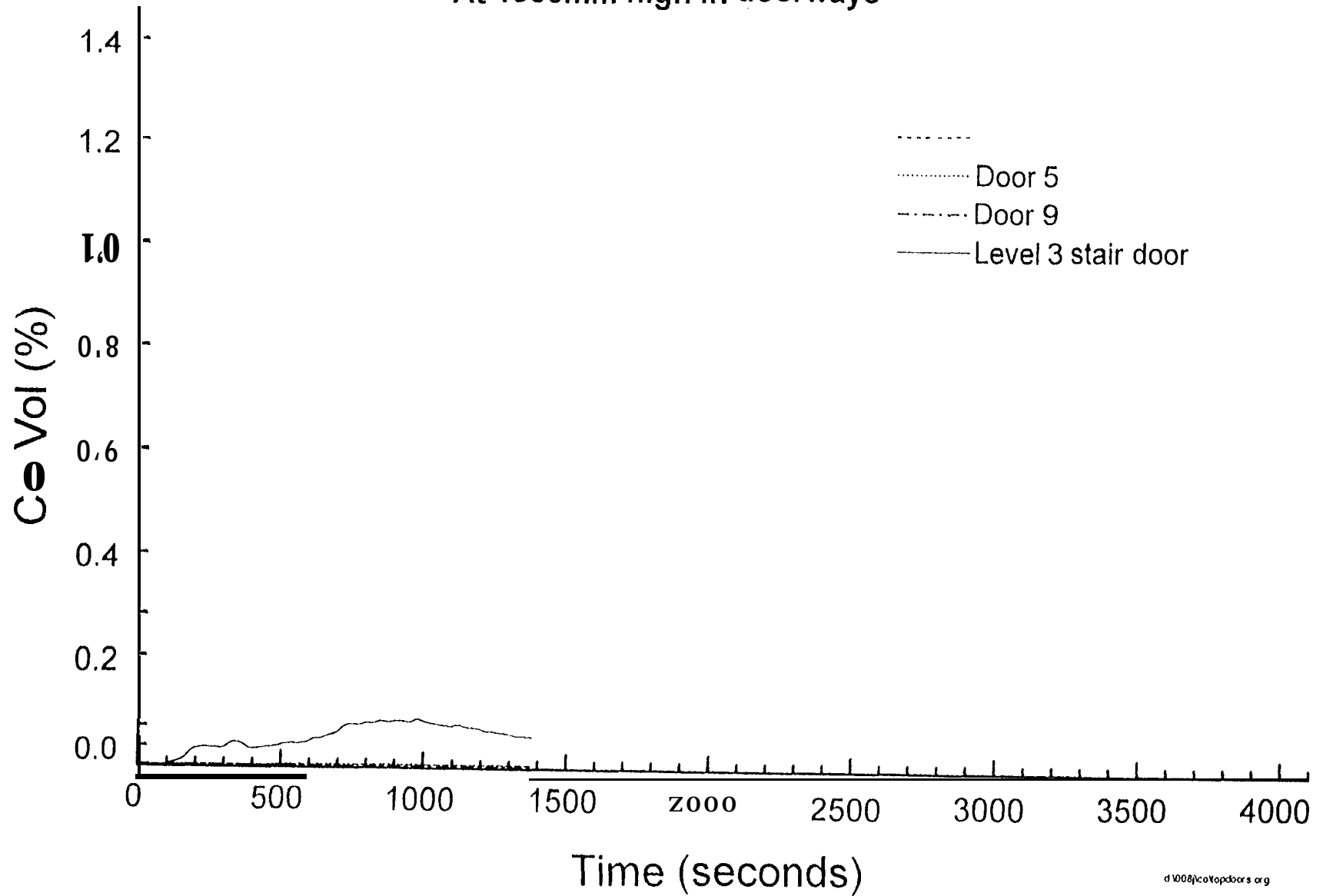

Fig. 7.3.5-4

Carbon monoxide concentration (Flaming fire in small room) - Test FMS7

At 1900mm high in doorways

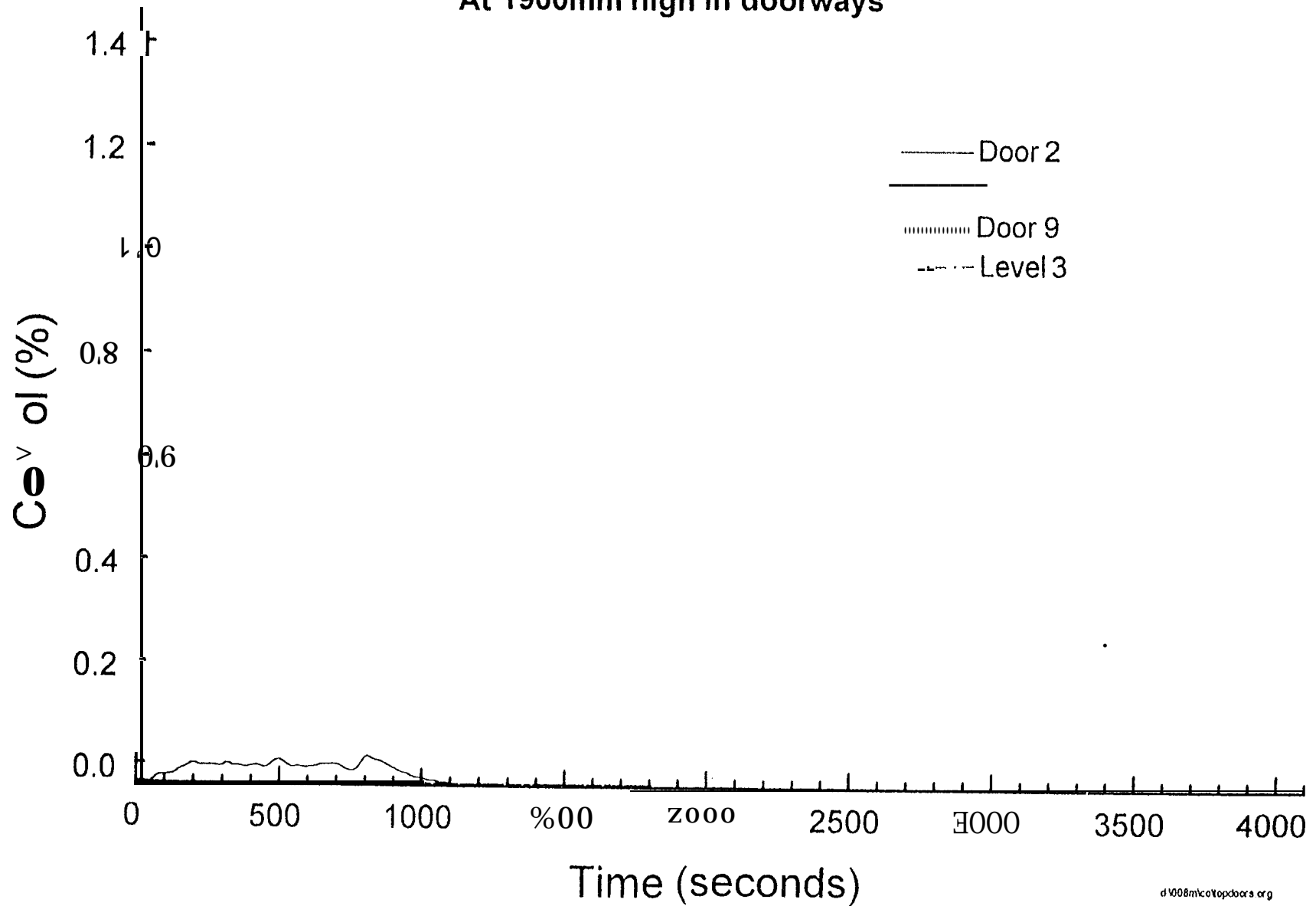

Fig. 7.3.5-5

Carbon monoxide concentration (Flaming fire in small room) - Test FMS8

At 1900mm high in doorways

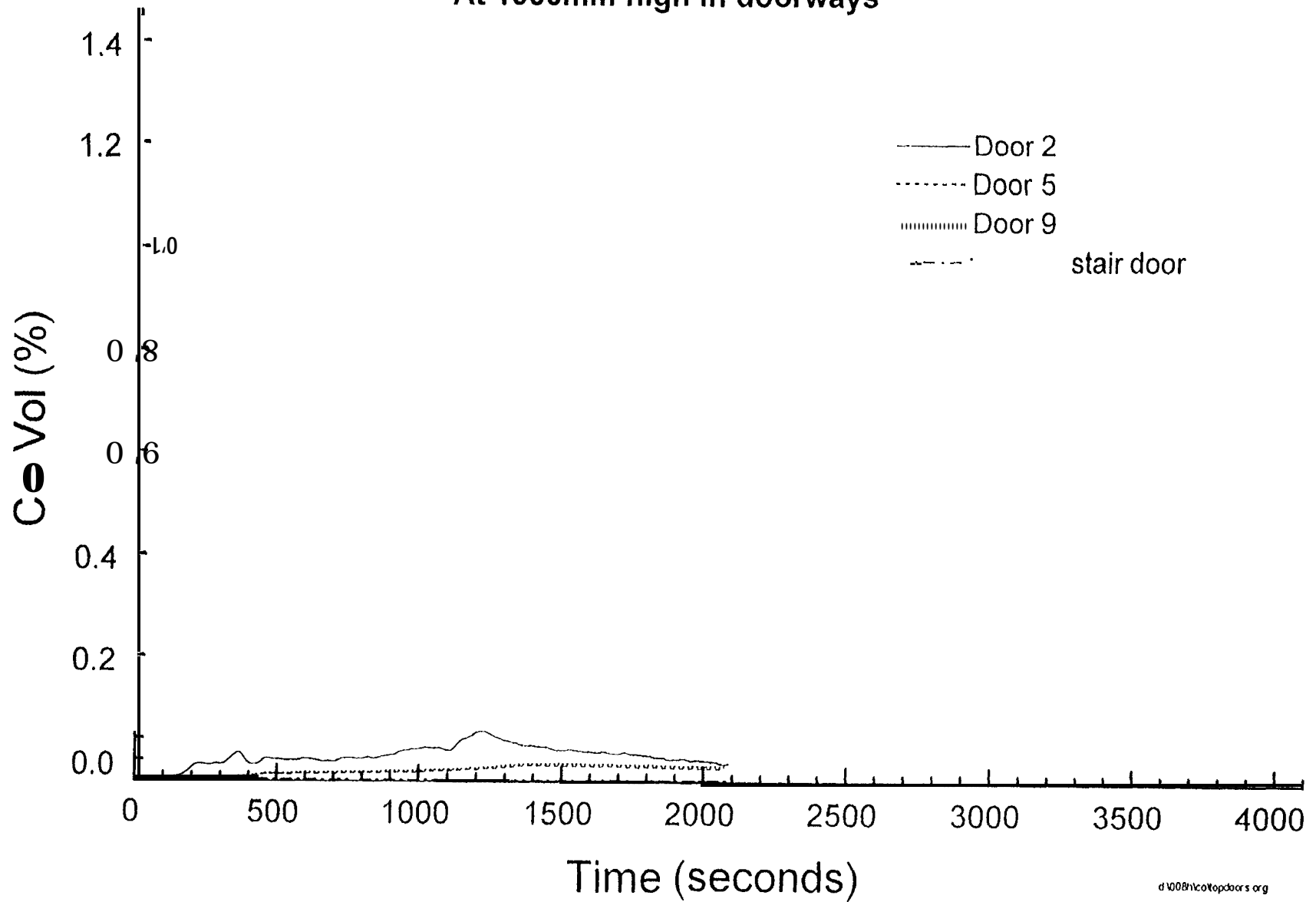

Fig. 7.3.5-6

Carbon monoxide concentration (flaming fire in small room) - Test MS10

At 1900mm high in doorways

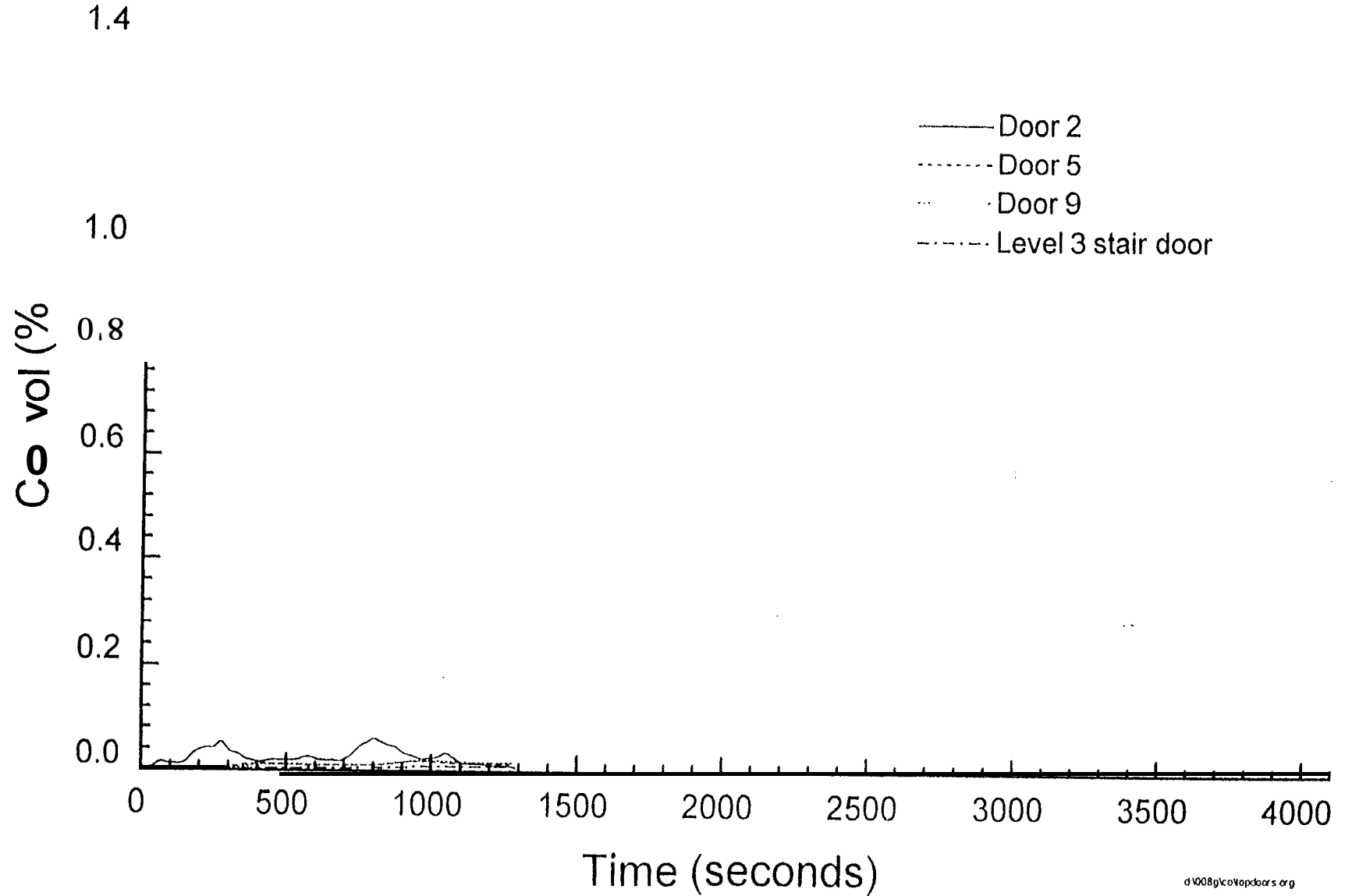

Fig. 7.3.6-1

Oxygen concentration (Flaming fire in small room) - Test FMS 4

Average of 3 points in room 102

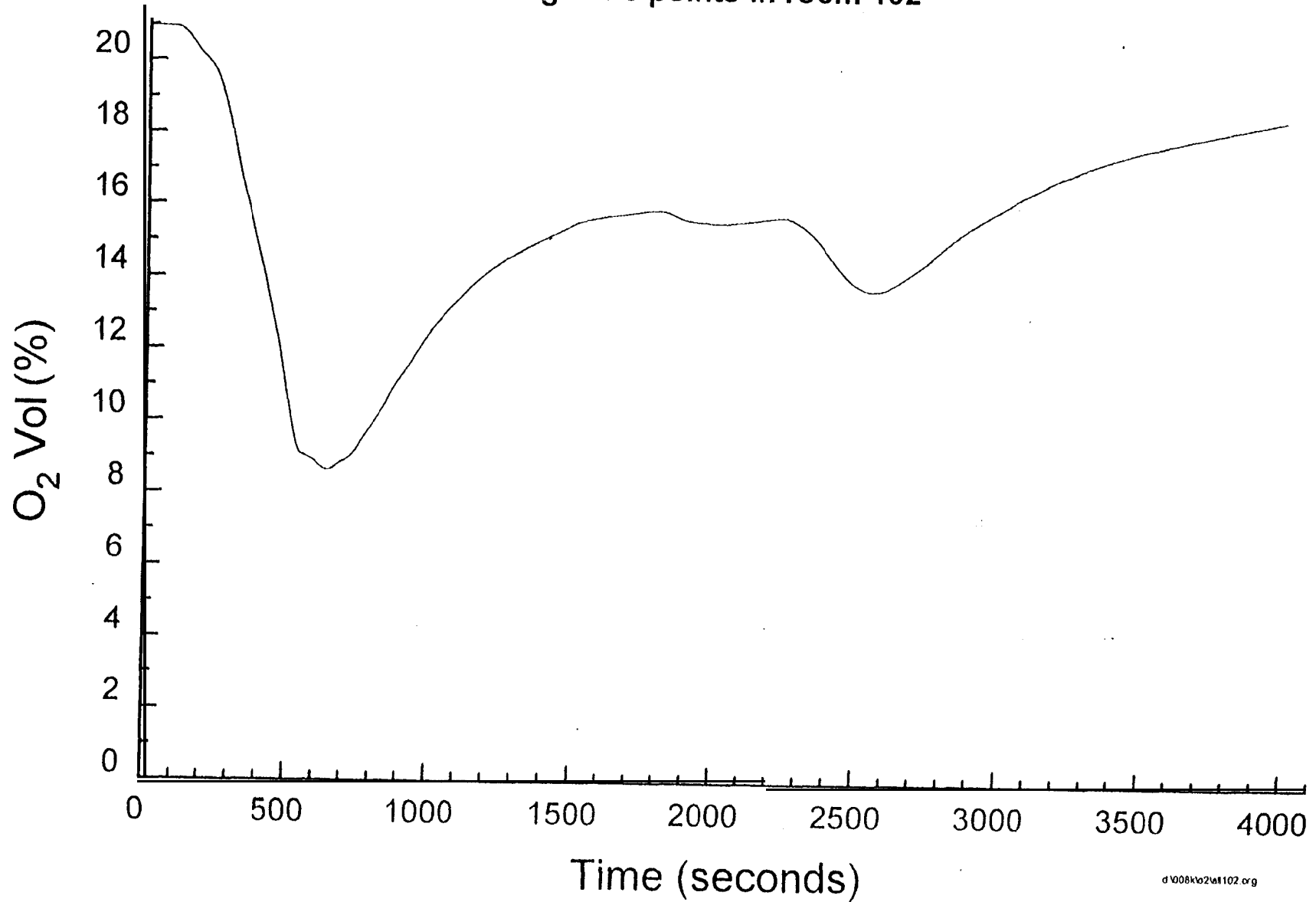

Fig. 7.3.6-2

Oxygen concentration (Flaming fire in small room) - Test FMS 5

Average of 3 points in room 102

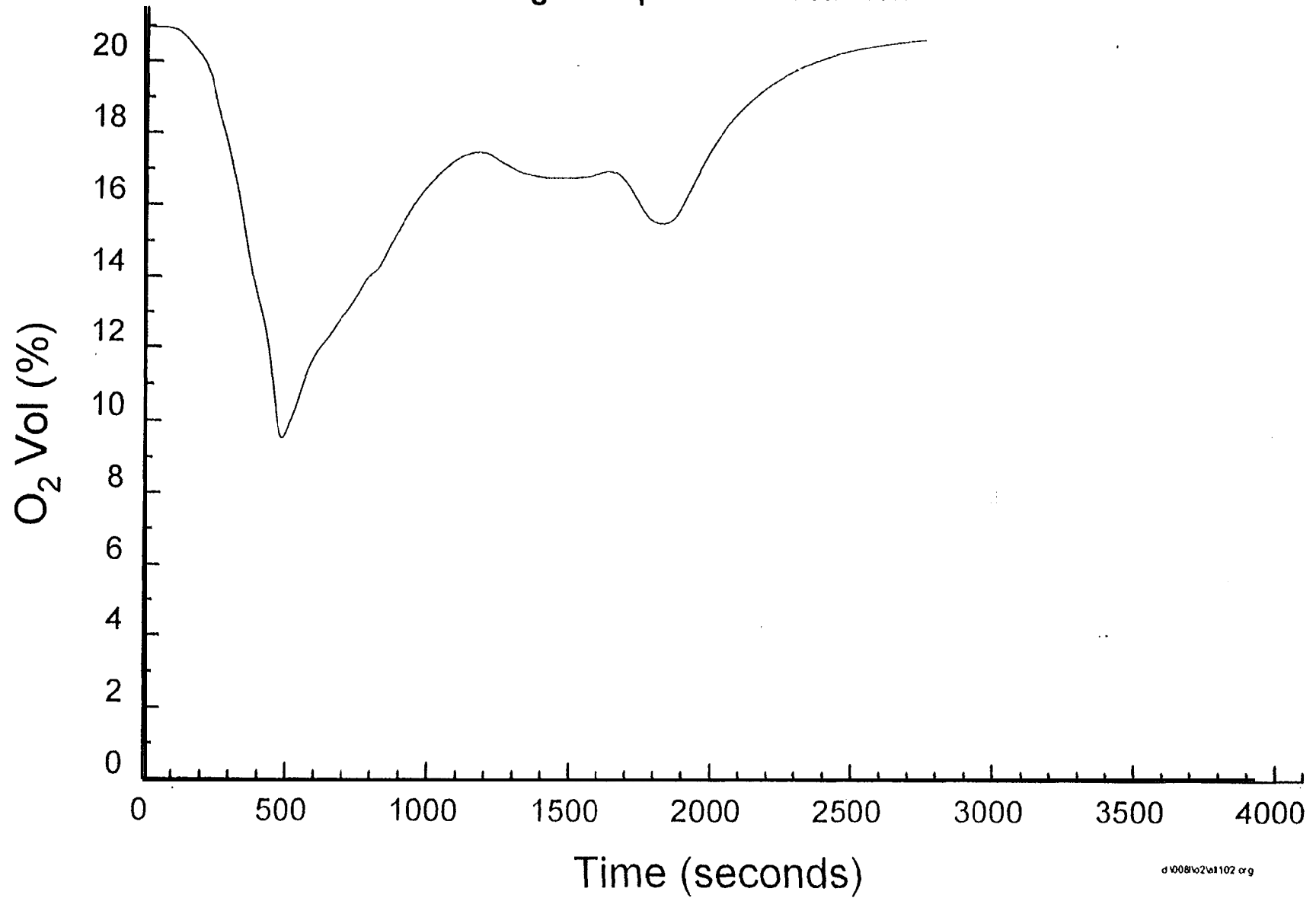

Fig. 7.3.6-3

Oxygen concentration (Flaming fire in small room) - Test F MS 6

Average of 3 points in room 102

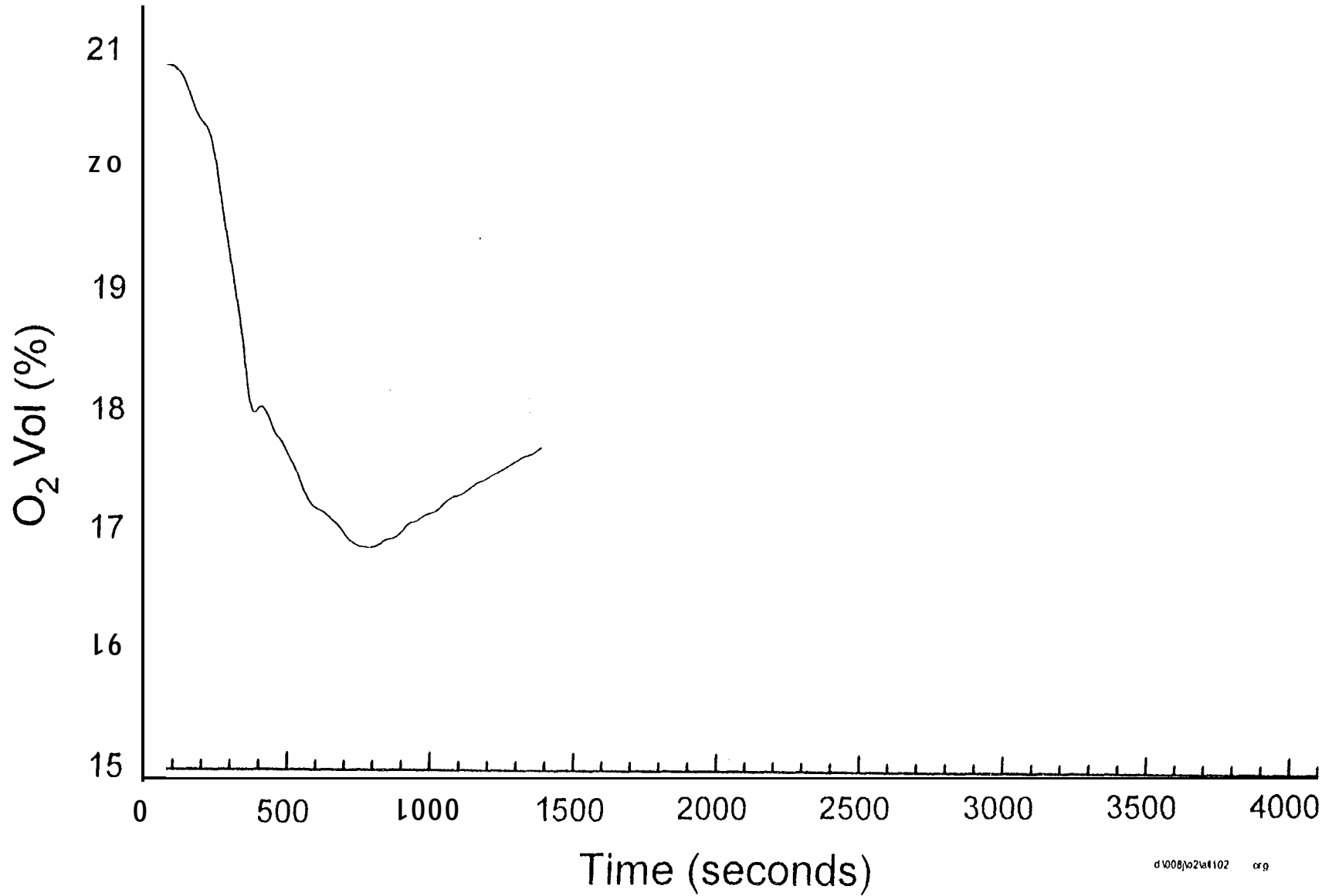

Fig. 7.3.6-4

Oxygen concentration (Flaming fire in small room) - Test FMS 7

Average of 3 points in room 102

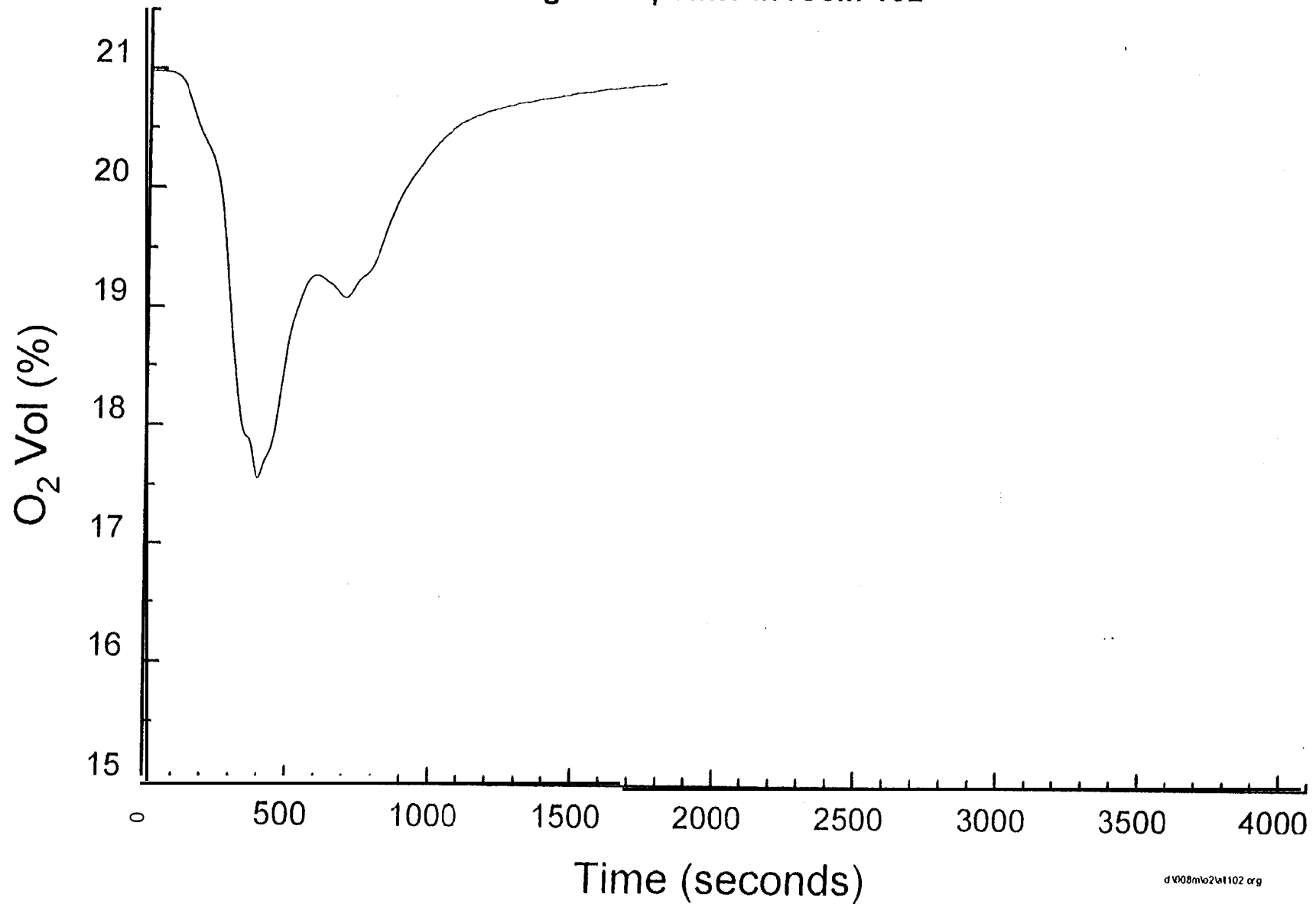

Fig. 7.3.6-5

Oxygen concentration (Flaming fire in small room) - Test FMS 8

Average of 3 points in room 102

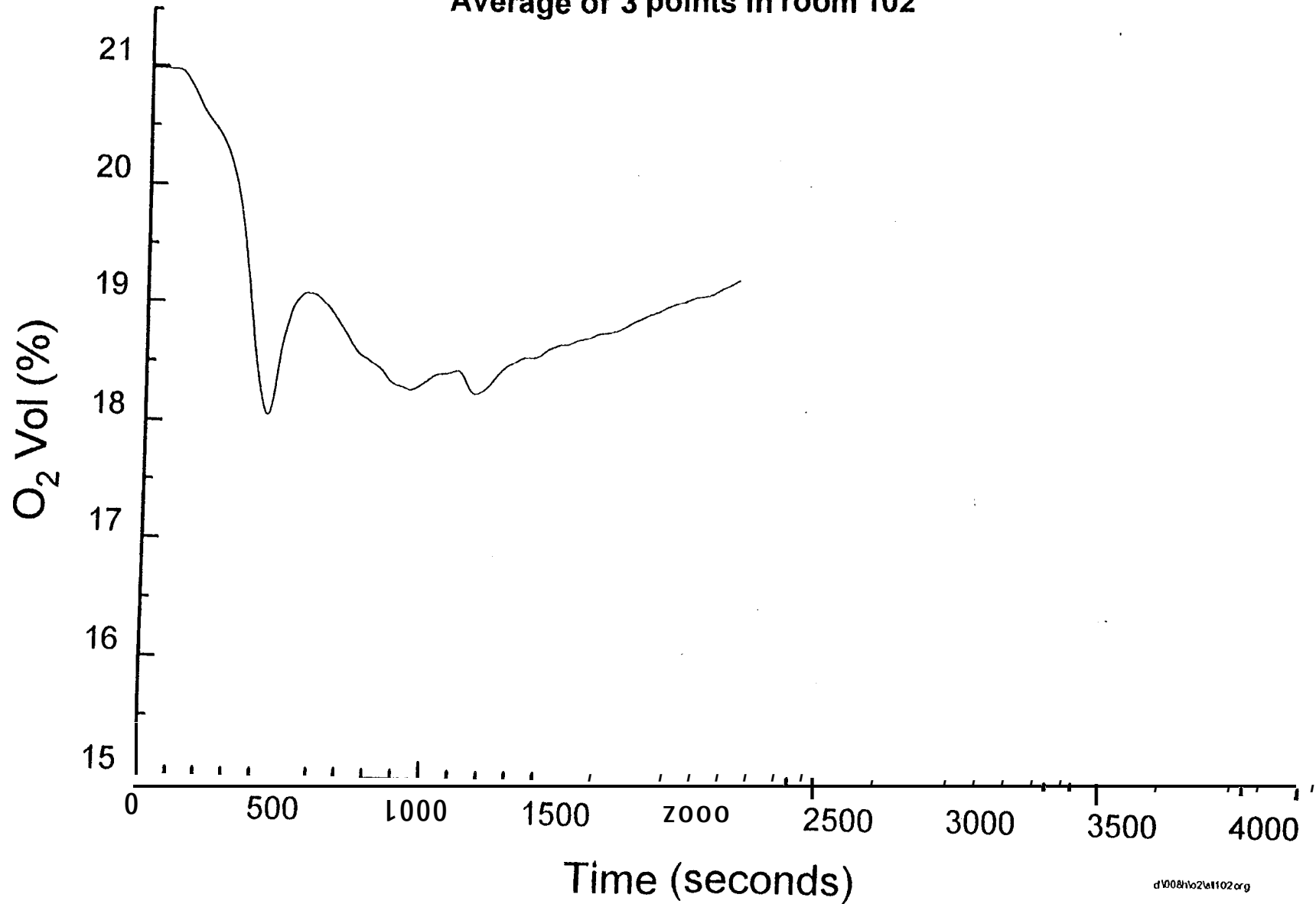
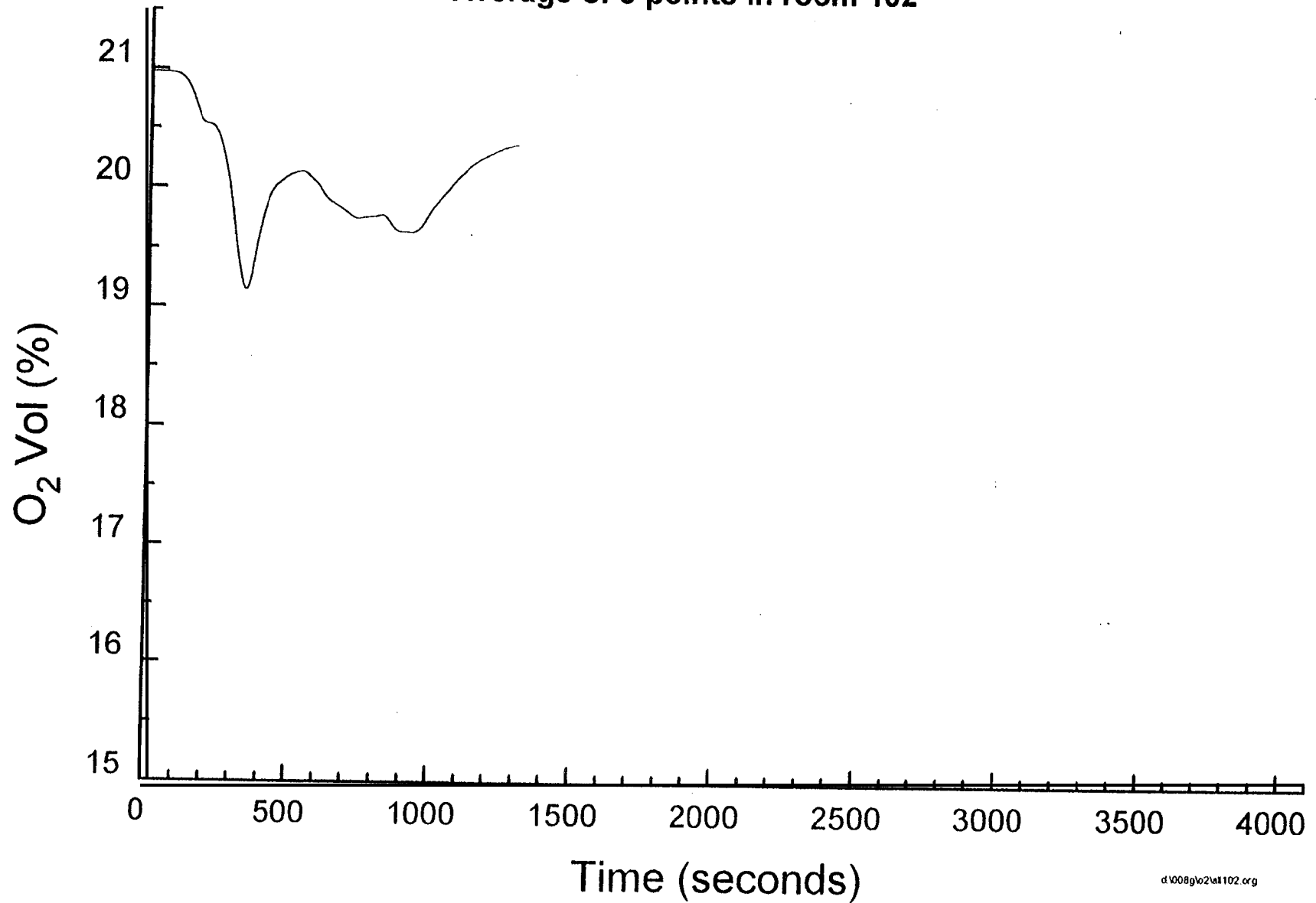

Fig. 7.3.6-6

Oxygen concentration (Flaming fire in small room) - Test FMS 10

Average of 3 points in room 102



and Oxygen concentrations - Test FMS4

Fig. 7.3.6-7

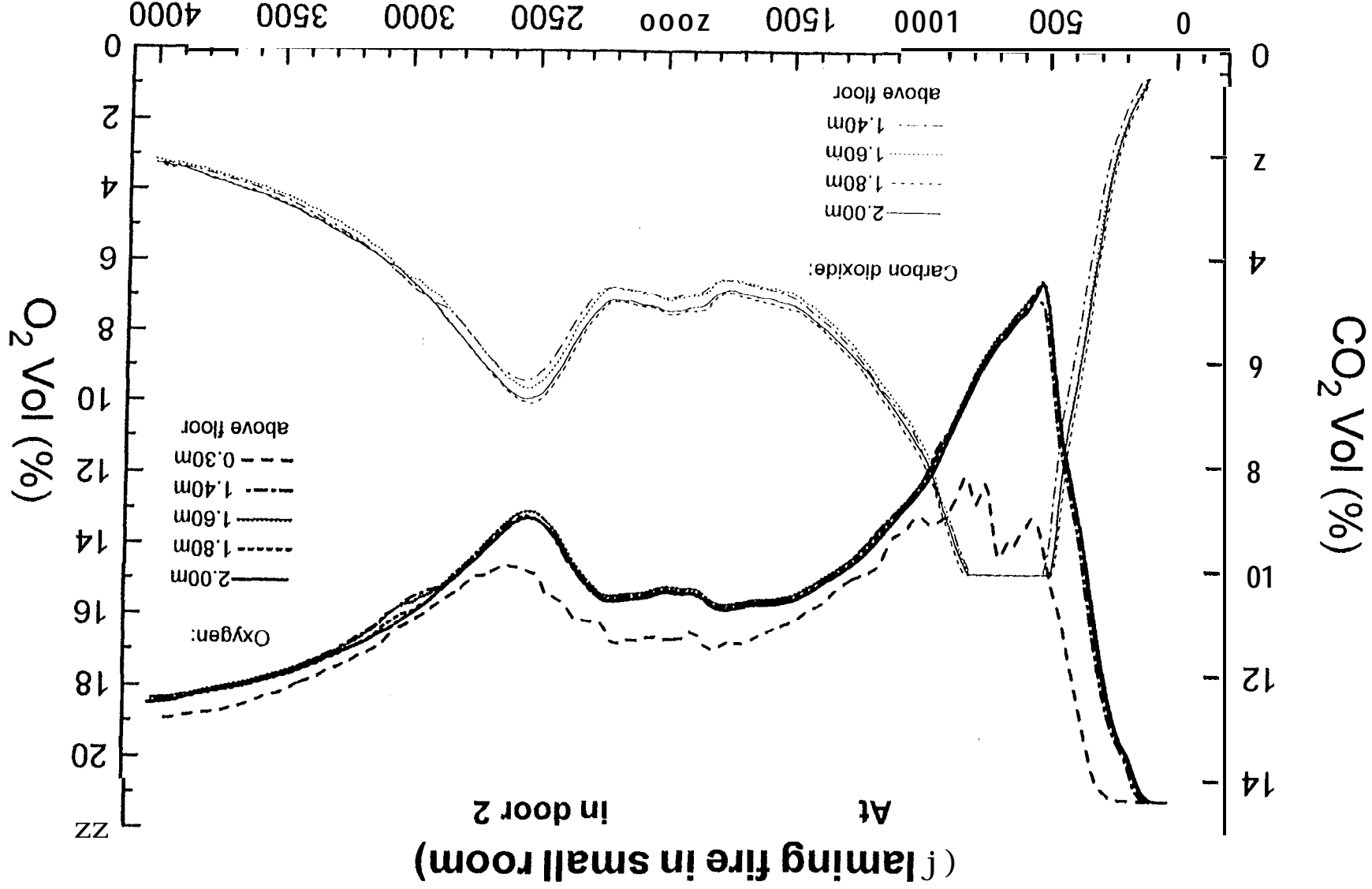

Fig. 7.3.6-8
and Oxygen concentrations - Test FMS5
(Flaming fire in small room)

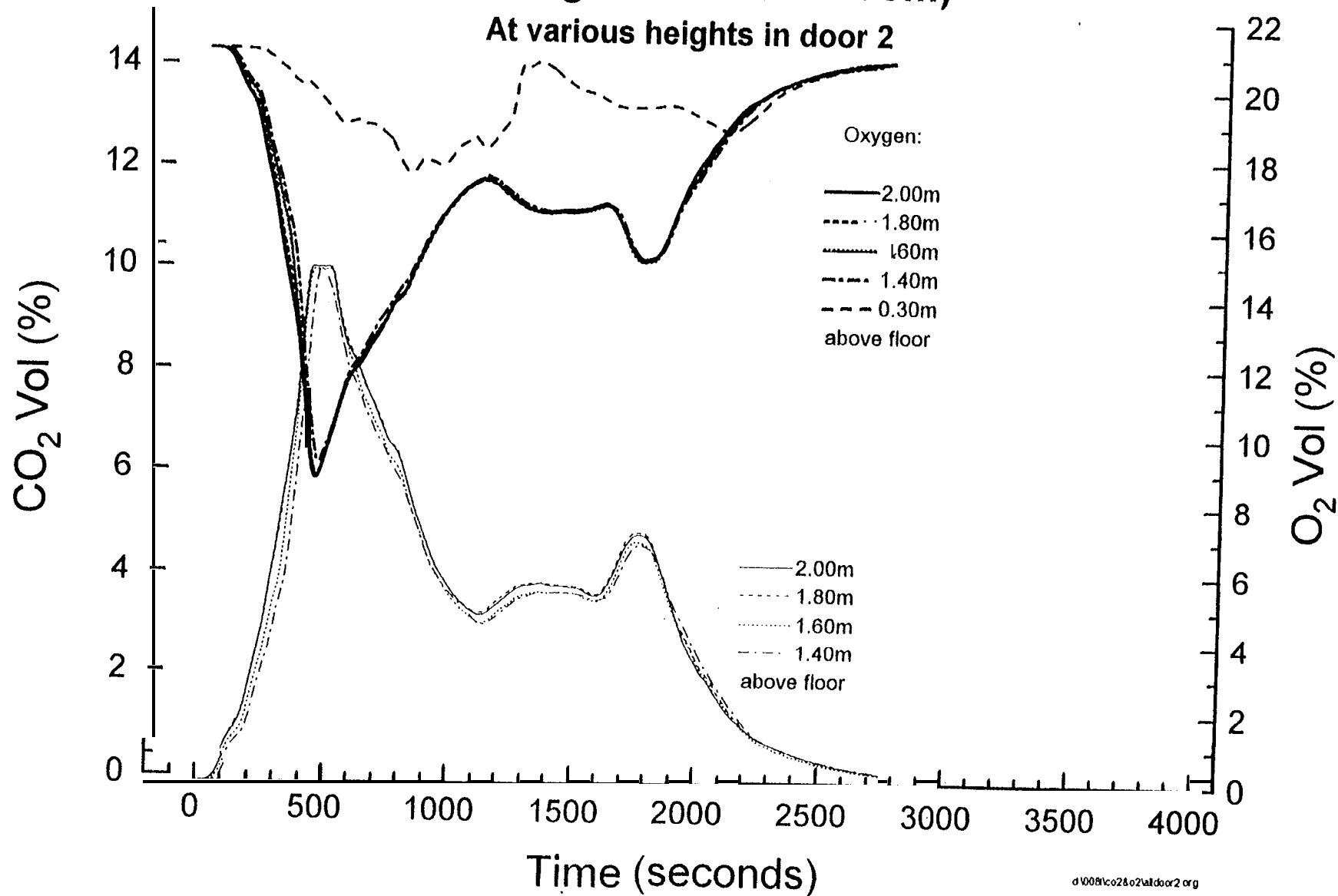

Fig. 7.3.6-9
Carbon dioxide and Oxygen concentrations - Test FMS6
(Flaming fire in small room)

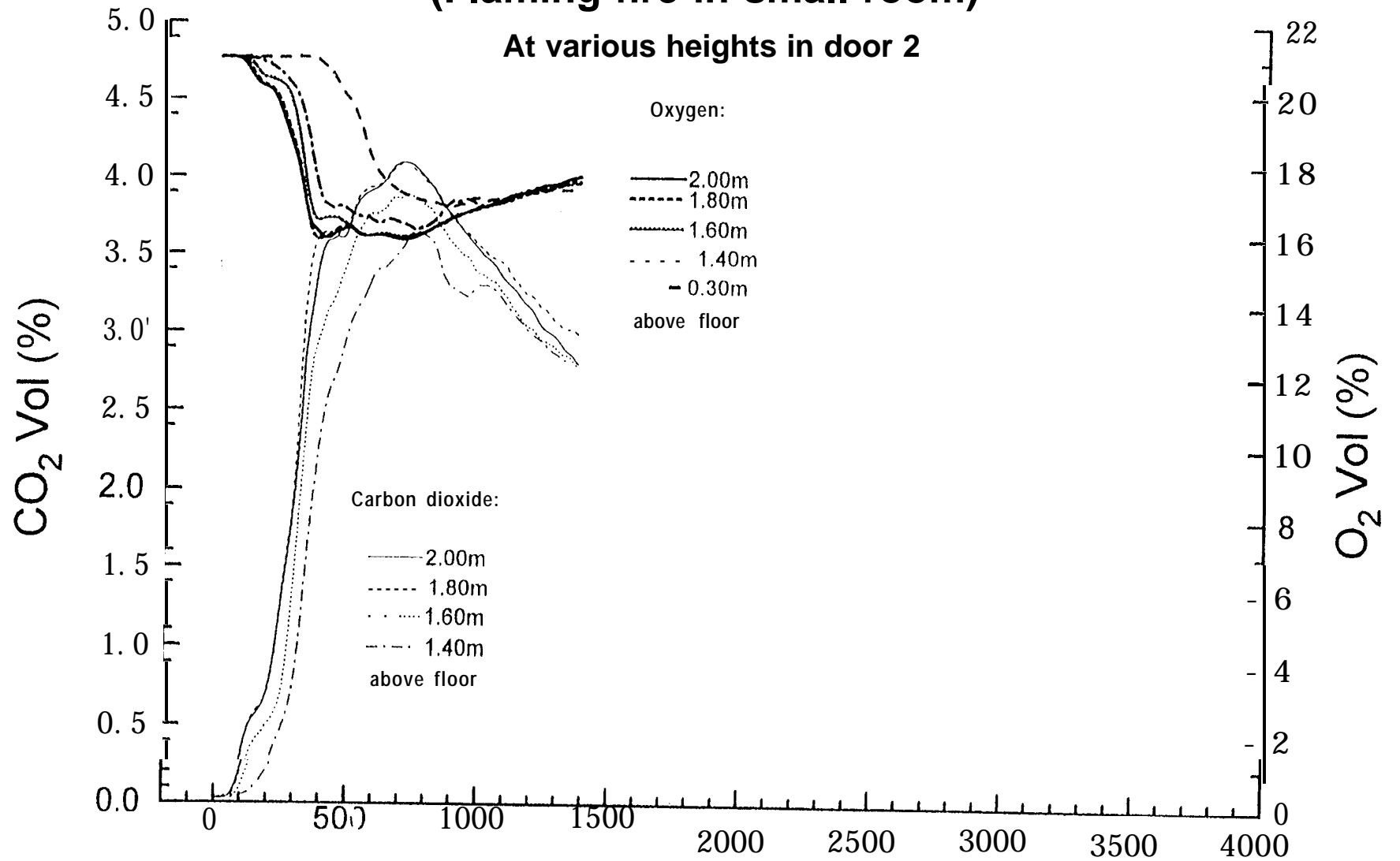

Fig. 7.3.6-I 0
Carbon dioxide and Oxygen concentrations - Test FMS7
(Flaming fire in small room)

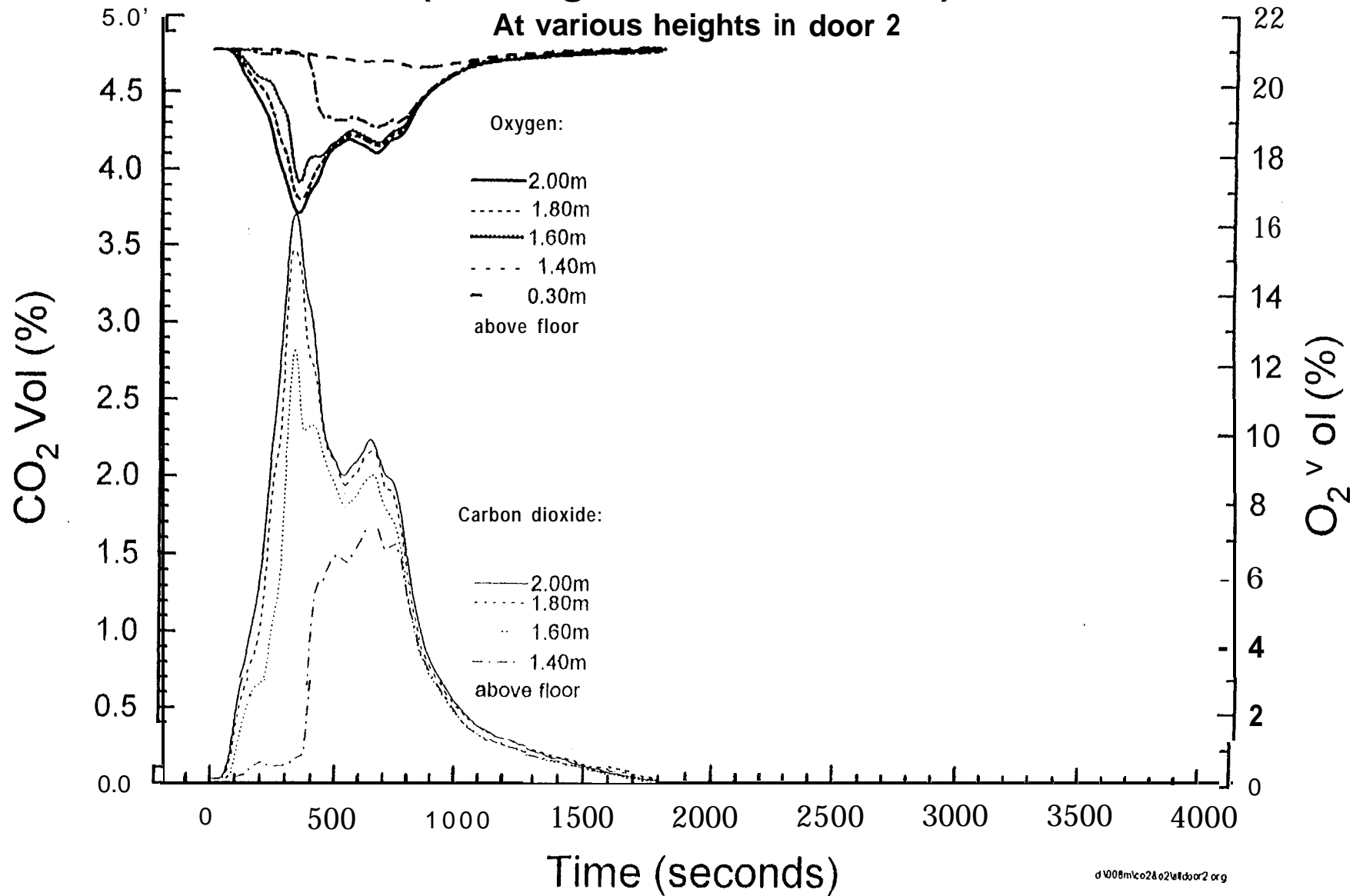
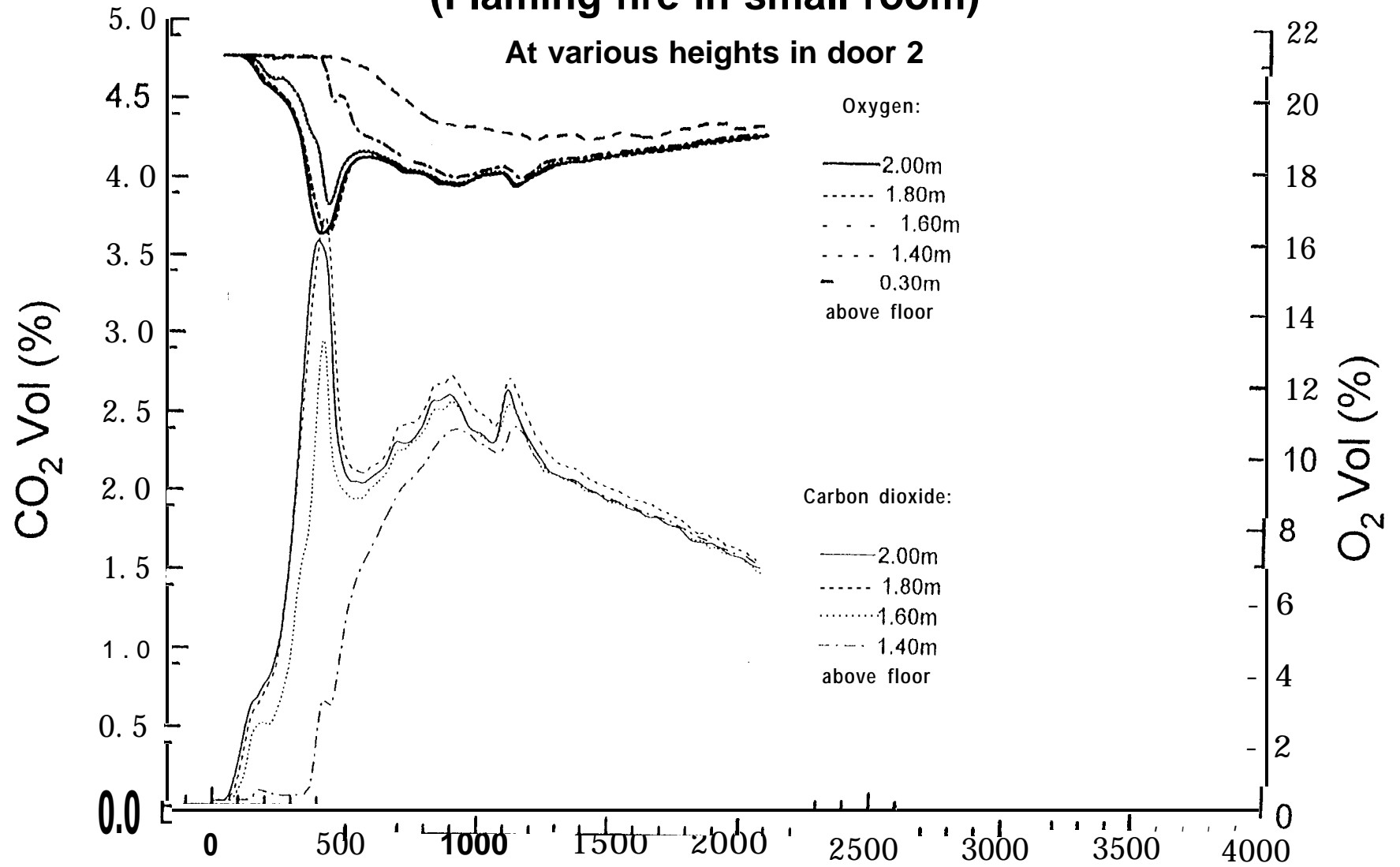

Fig. 7.3.6-I 1
Carbon dioxide and Oxygen concentrations - Test FMS8
(Flaming fire in small room)



d:\0081\co2&o2\door2.org

Fig. 7.3.6-I 2
Carbon dioxide and Oxygen concentrations - Test FMS10
(Flaming fire in small room)

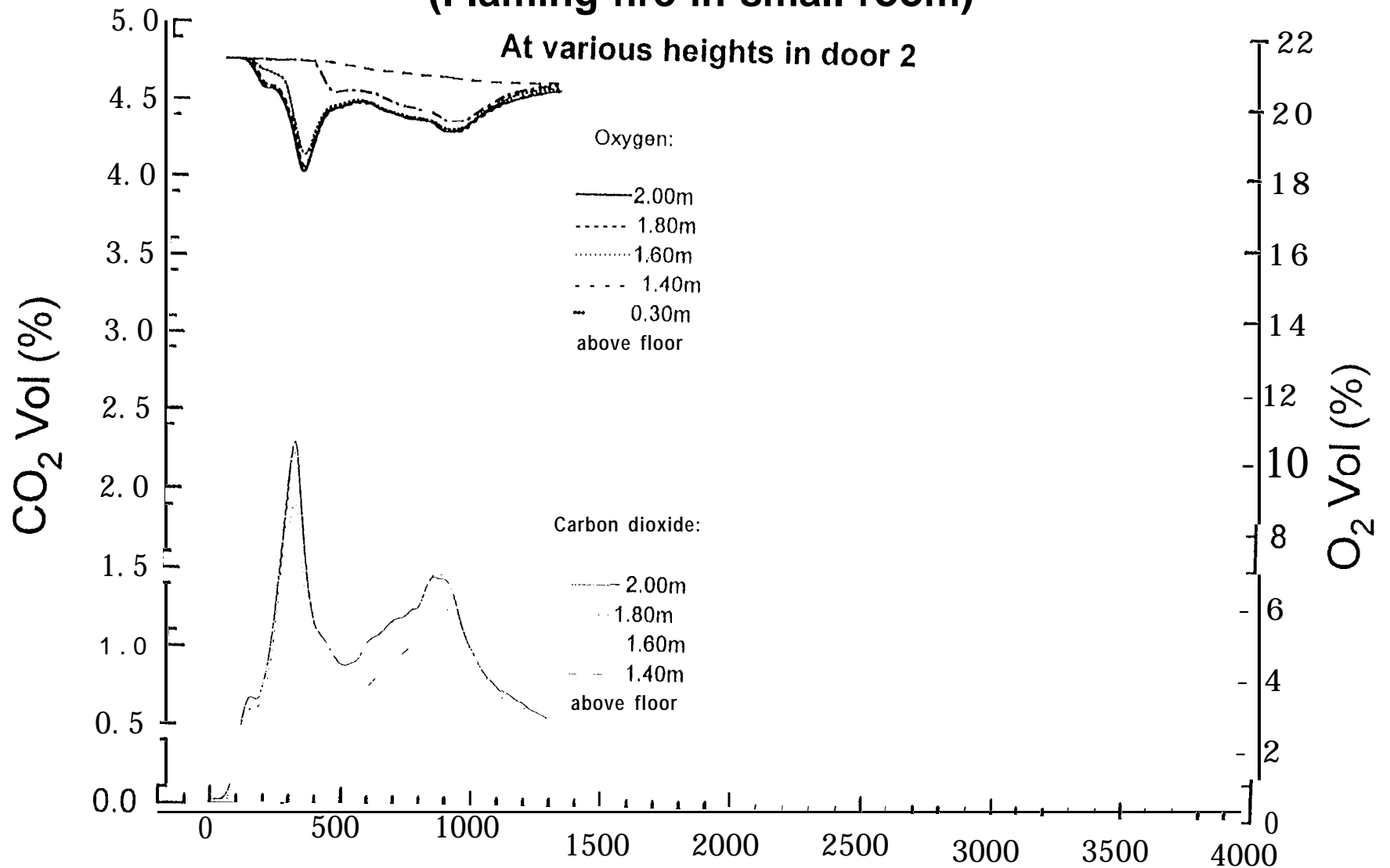

Fig. 7.3.7-I

Smoke obscuration and temperature - Test FMS4
(Flaming fire in small room)

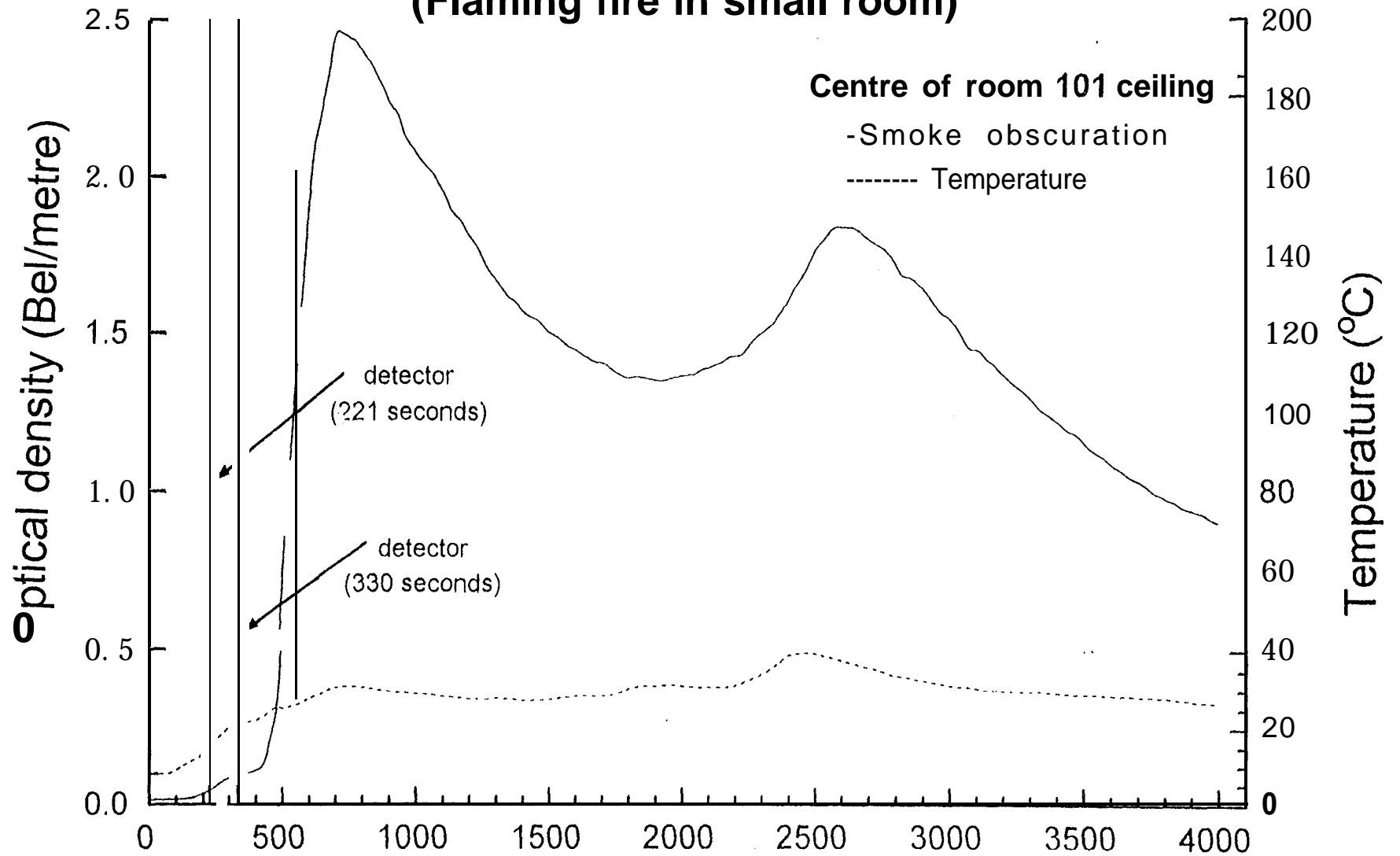
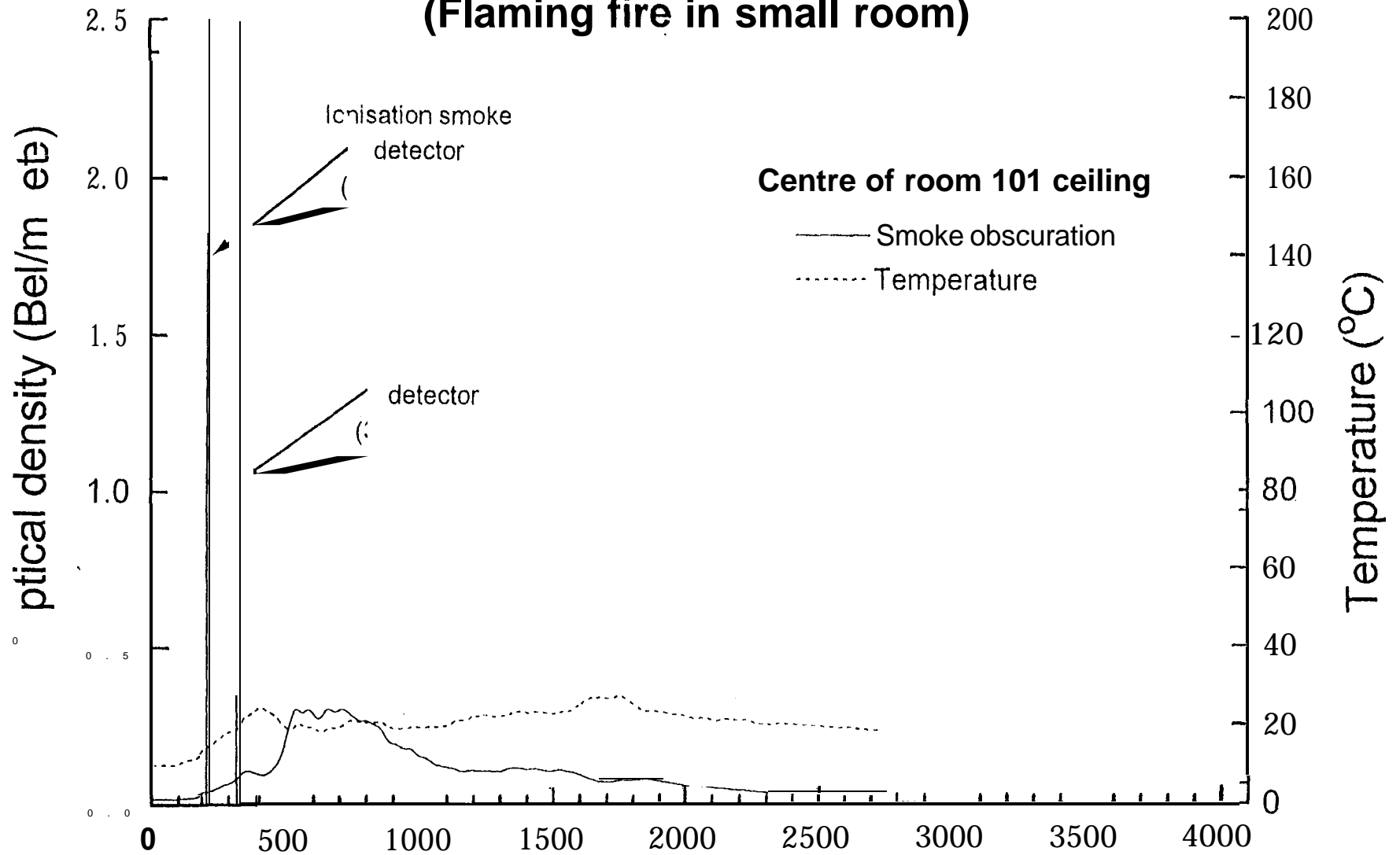

Fig. 7.3.7-2

Smoke obscuration and temperature - Test FMS5
(Flaming fire in small room)



Smoke obscuration and temperature - Test FMS6 (Flaming fire in small room)

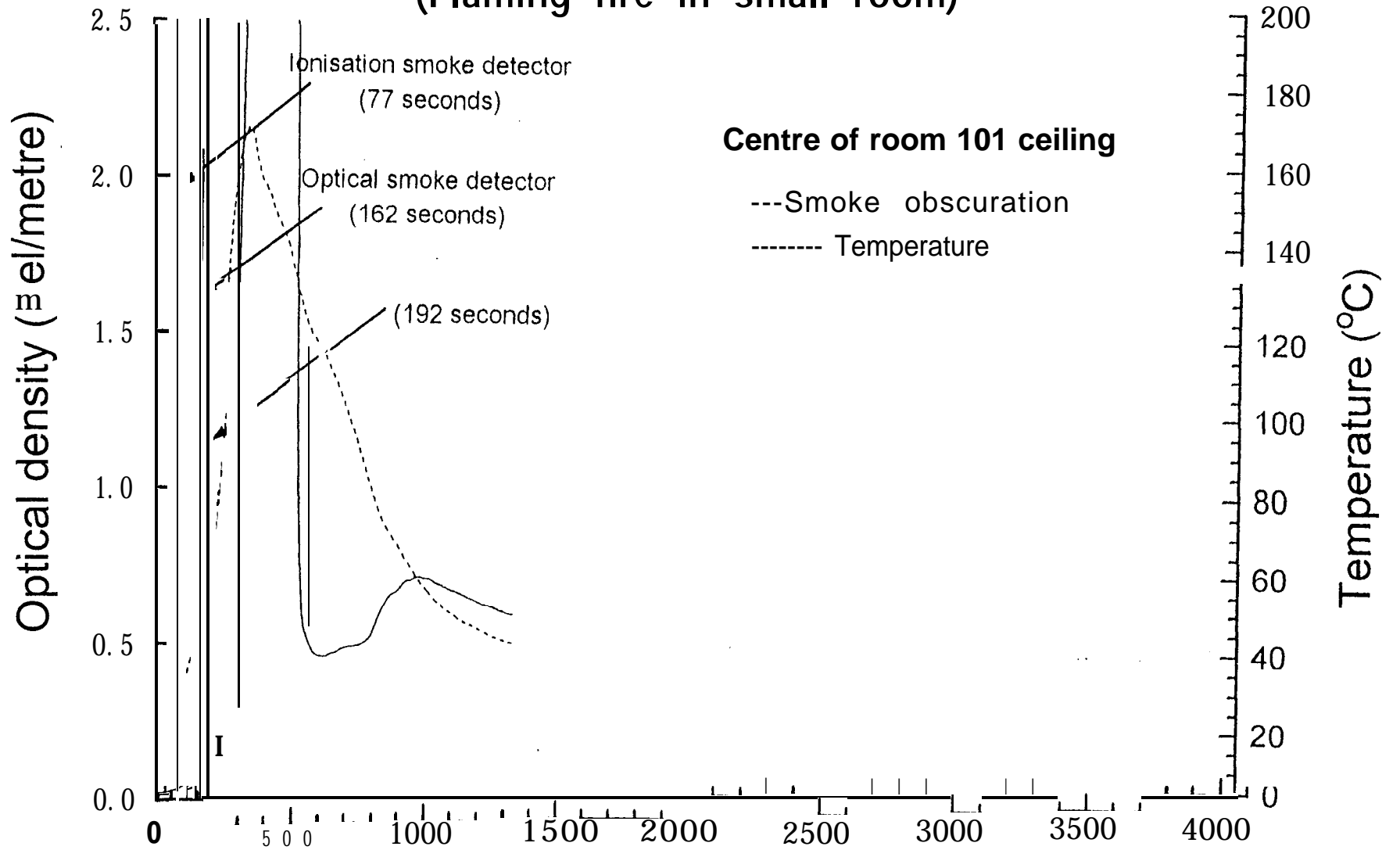

Fig. 7.3.7-4
Smoke obscuration and temperature - Test FMS7
(Flaming fire in small room)

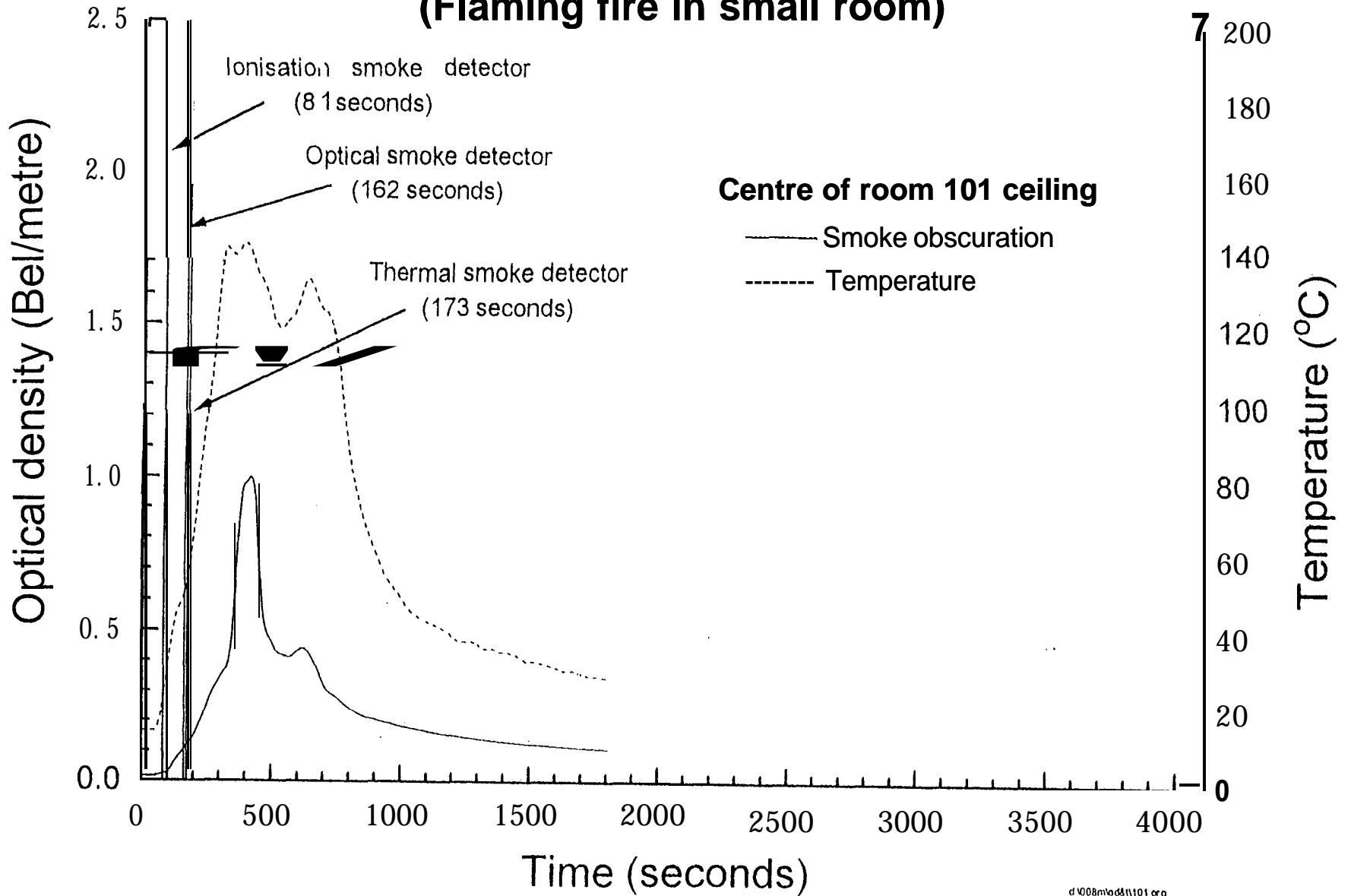

Fig. 7.3.7-5
Smoke obscuration and temperature - Test FMS8
(Flaming fire in small room)

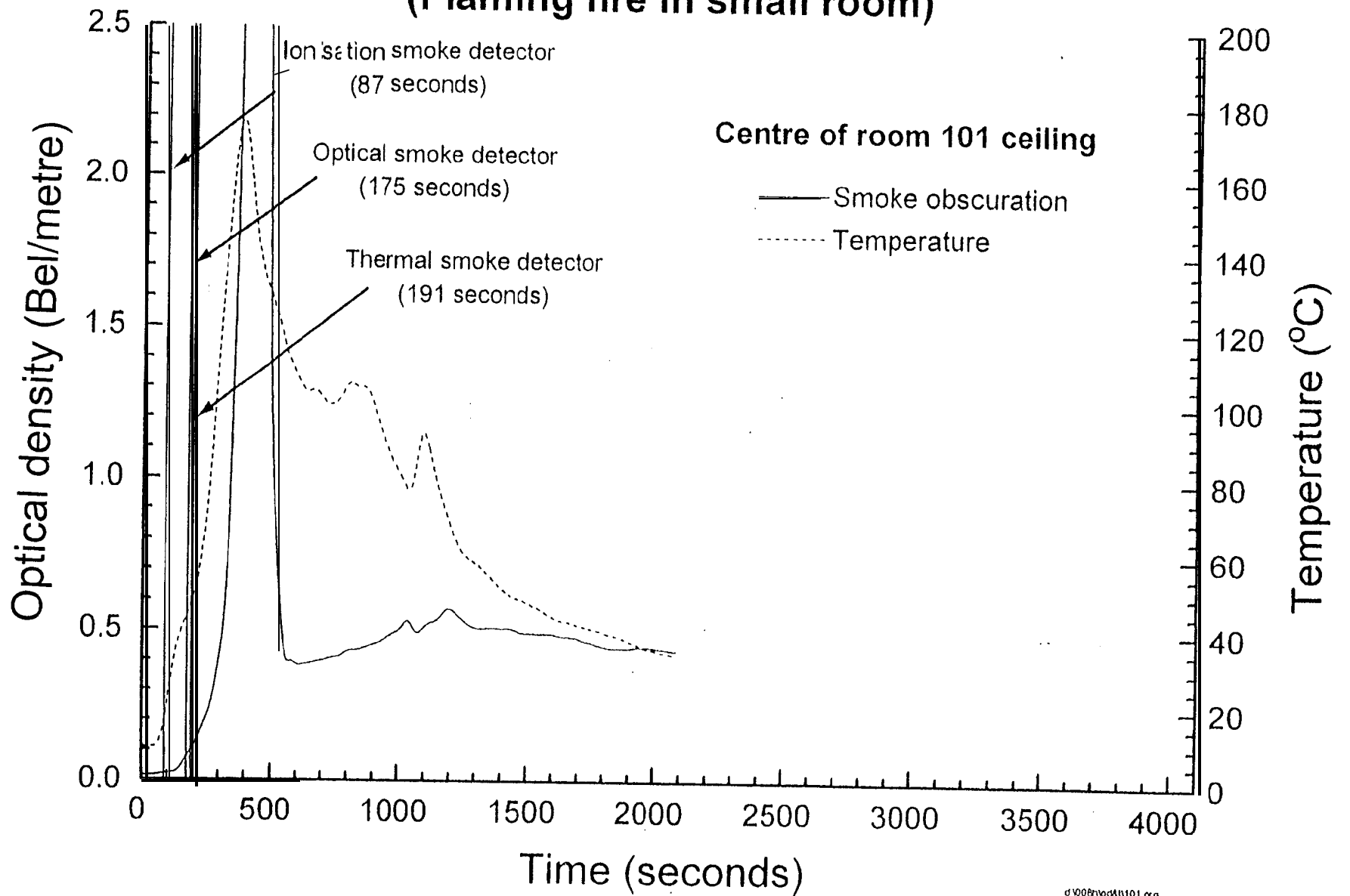

Fig. 7.3.7-6
Smoke obscuration and temperature - Test FMS10
(Flaming fire in small room)

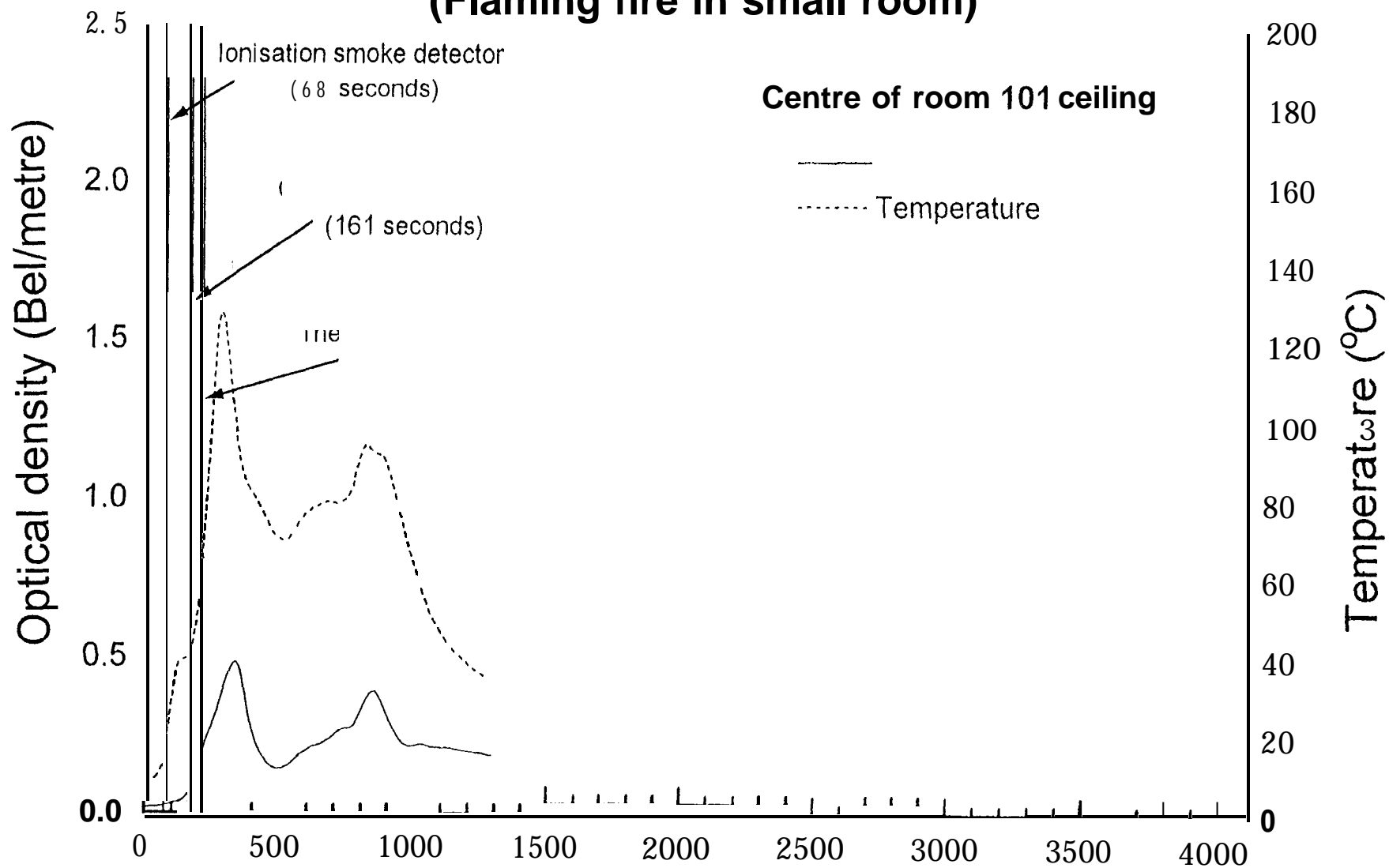

Fig. 7.3.7-7
Smoke obscuration and temperature - Test FMS4
(Flaming fire in small room)

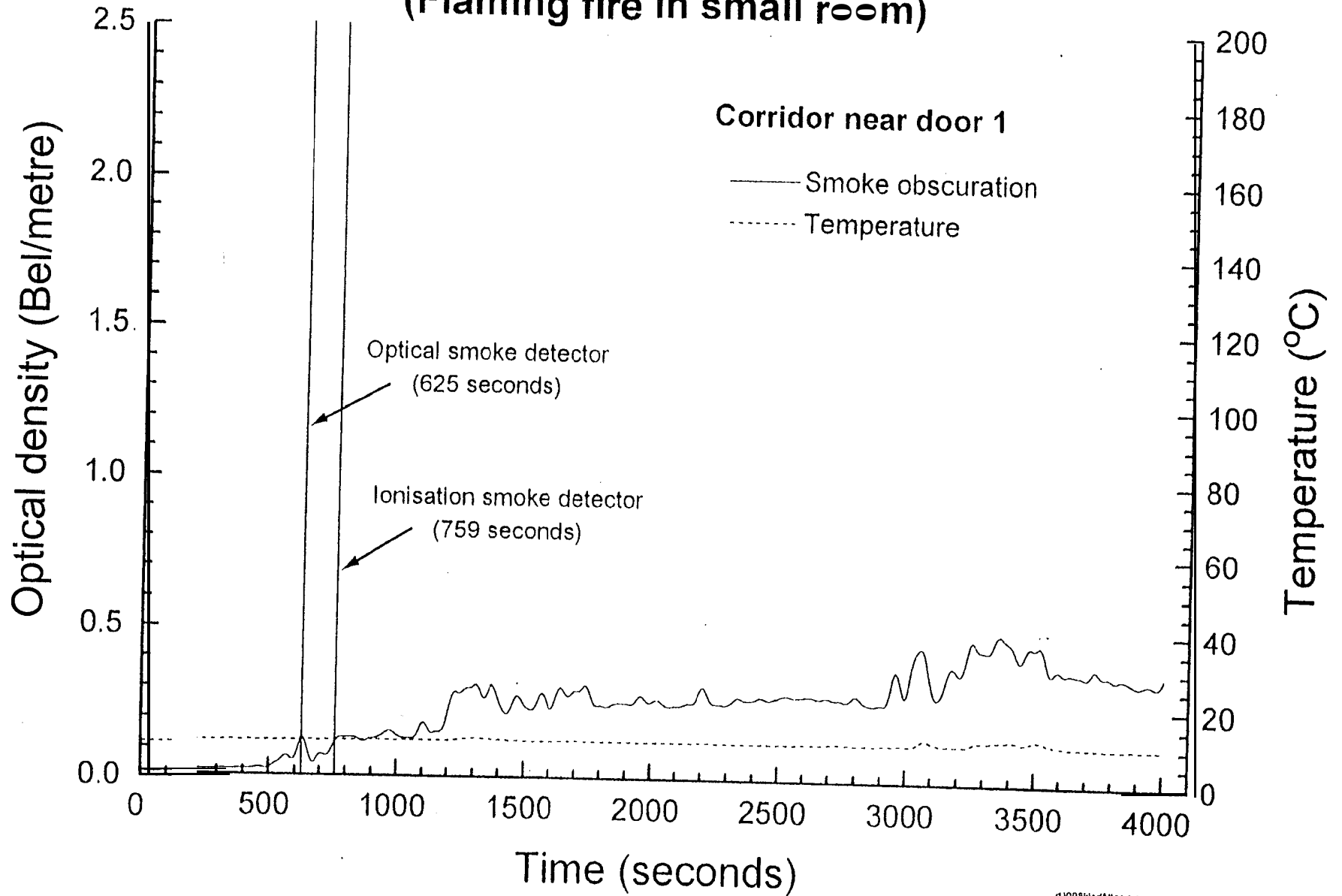

Fig. 7.3.7-8
Smoke obscuration and temperature - Test FMS5
(Flaming fire in small room)

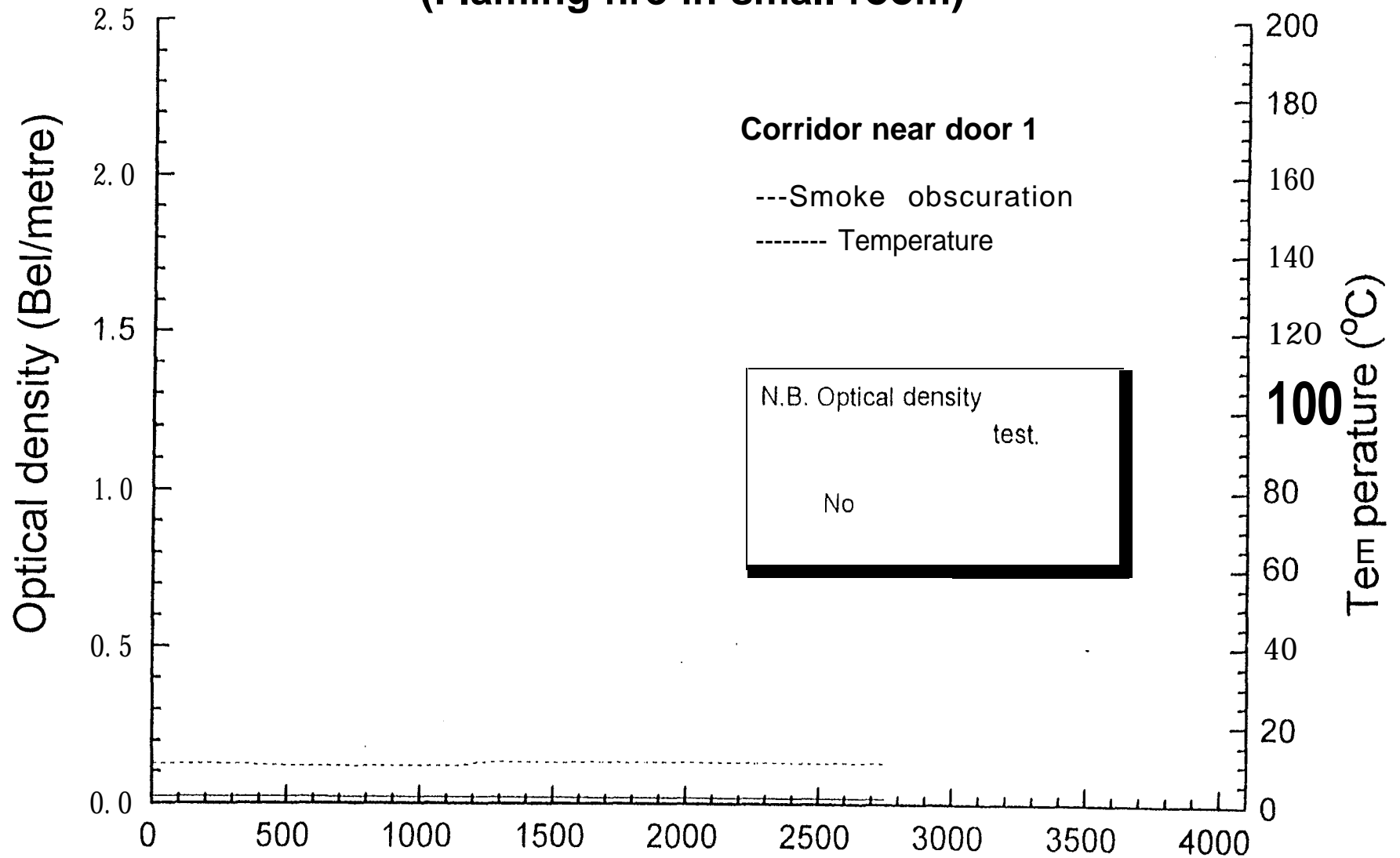

Fig. 7.3.7-9
Smoke obscuration and temperature - Test FMS6
(Flaming fire in small room)

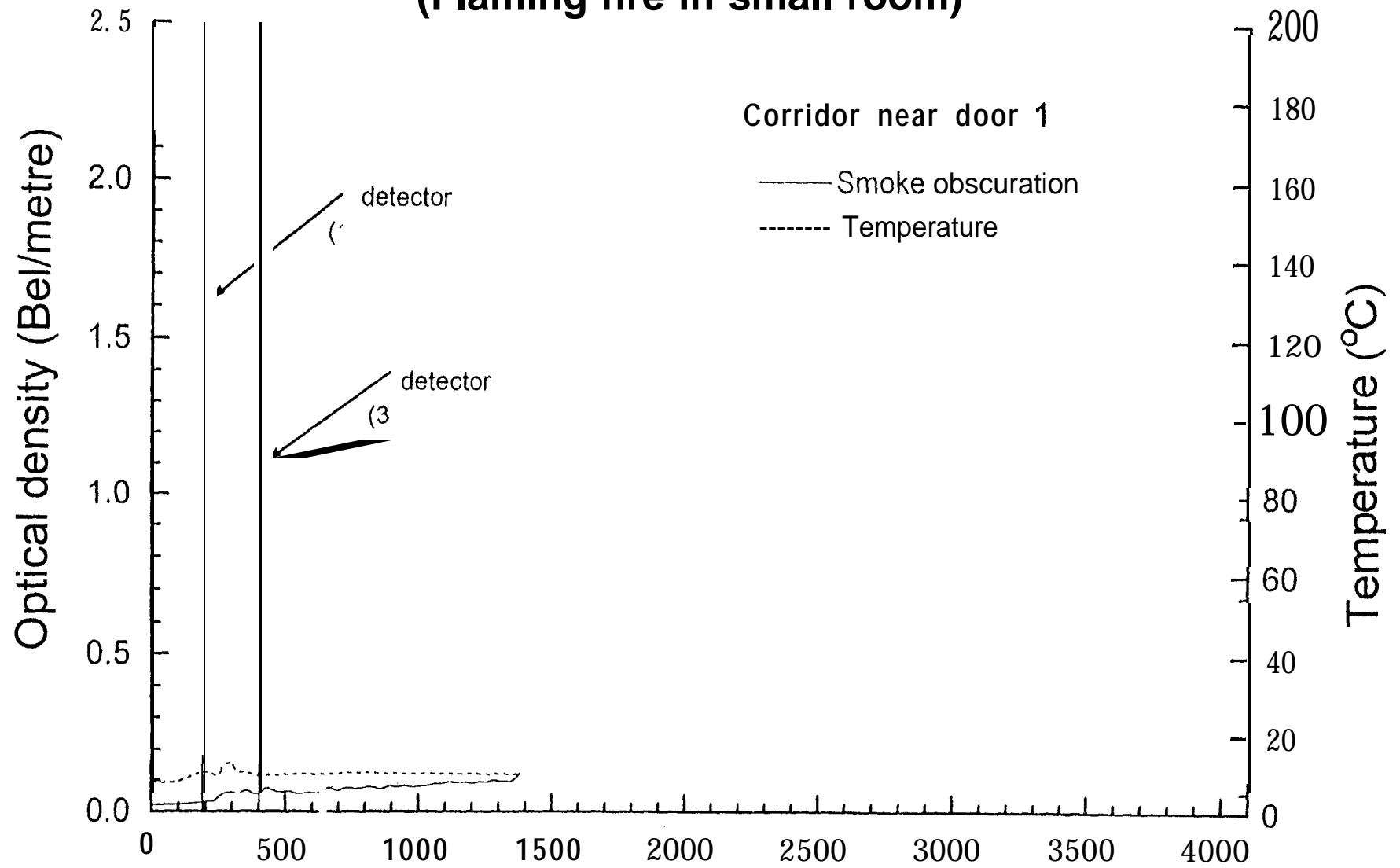

Fig. 7.3.7-10
Smoke obscuration and temperature - Test FMS7
(Flaming fire in small room)

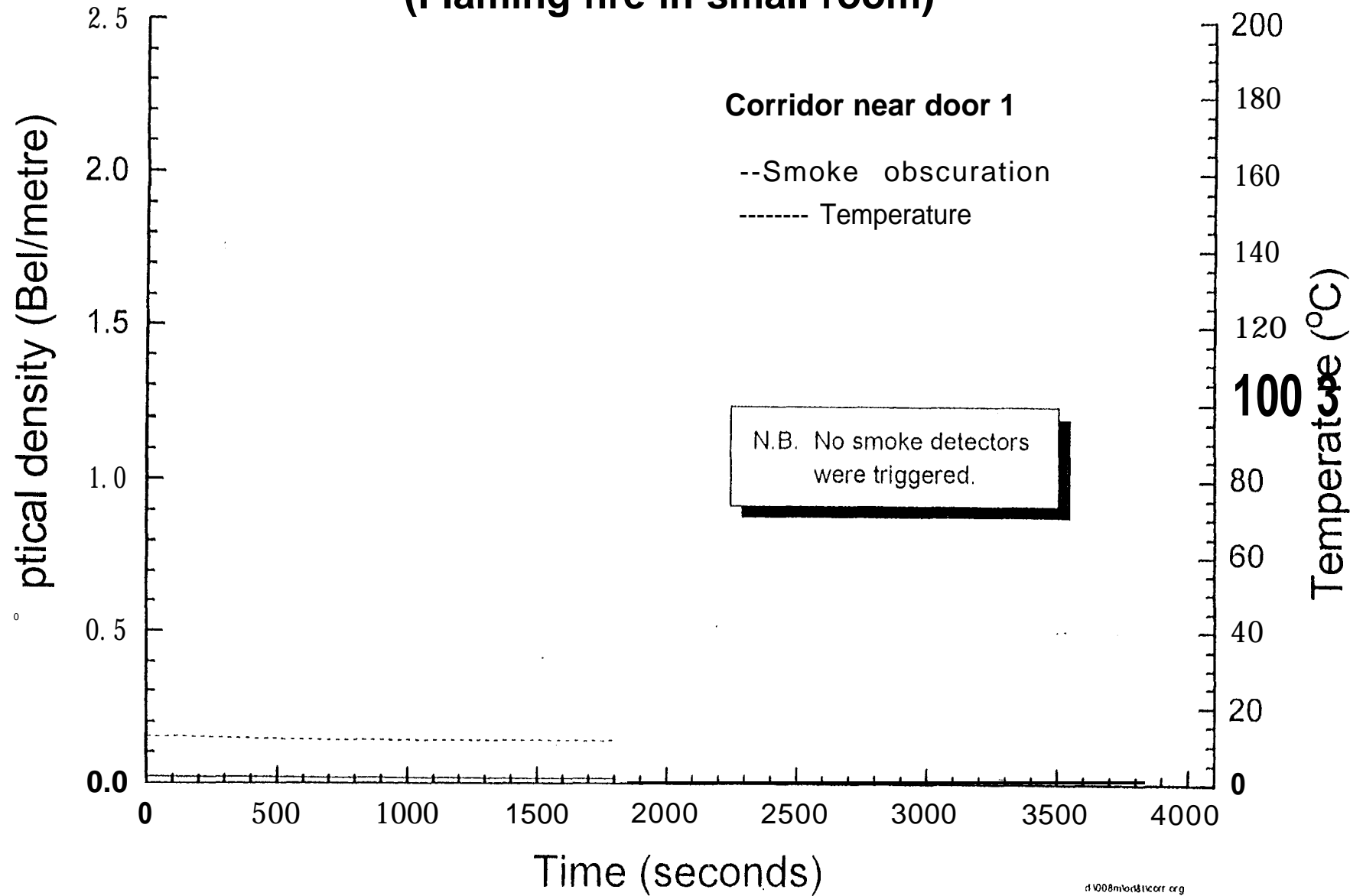

Fig. 7.3.7-I 1

Smoke obscuration and temperature - Test FMS8
(Flaming fire in small room)

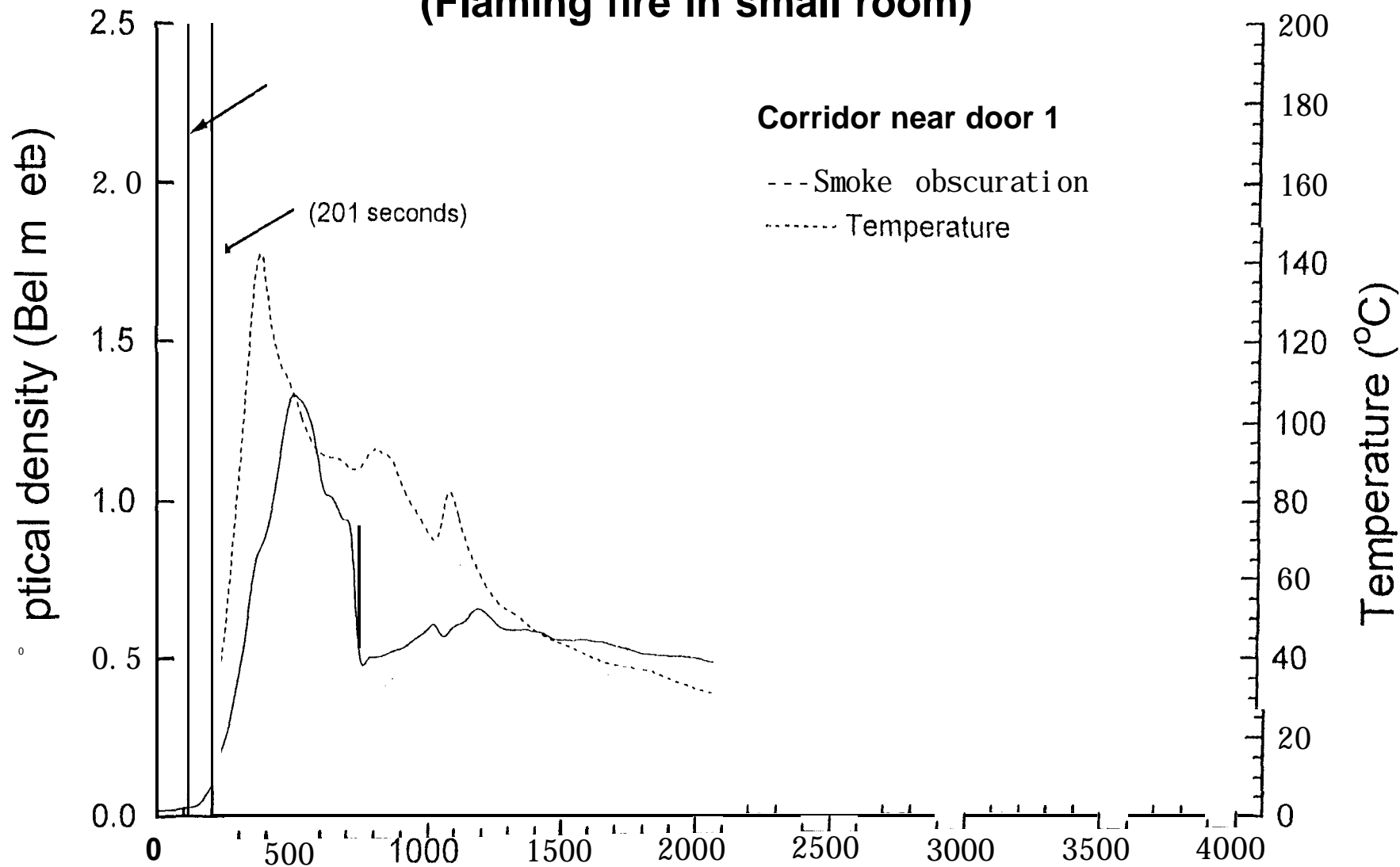

Fig. 7.3.7-I 2
Smoke obscuration and temperature - Test FMS10
(Flaming fire in small room)

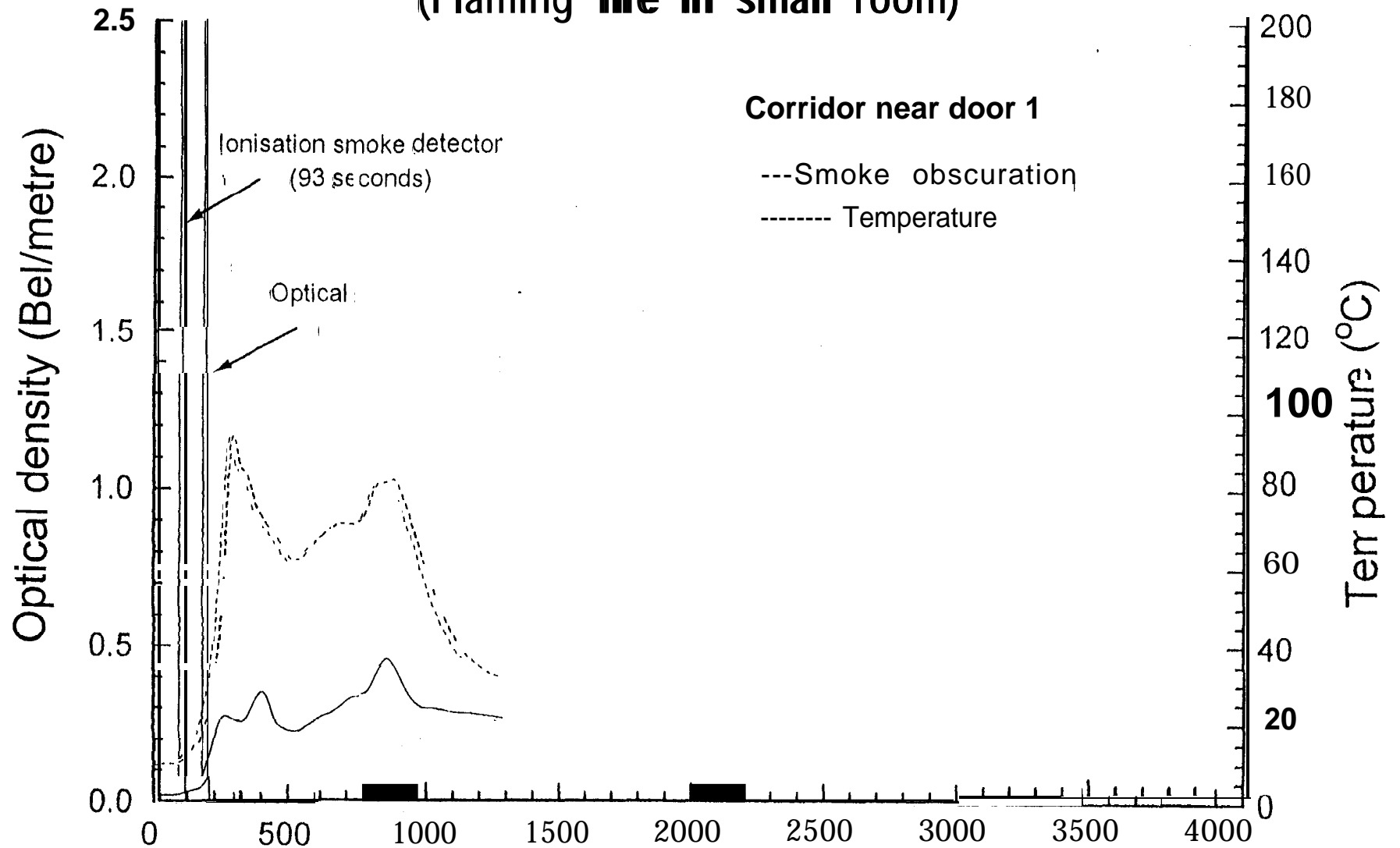

Fig. 7.3.7-I 3
Smoke obscuration and temperature - Test FMS5
(Flaming fire in small room)

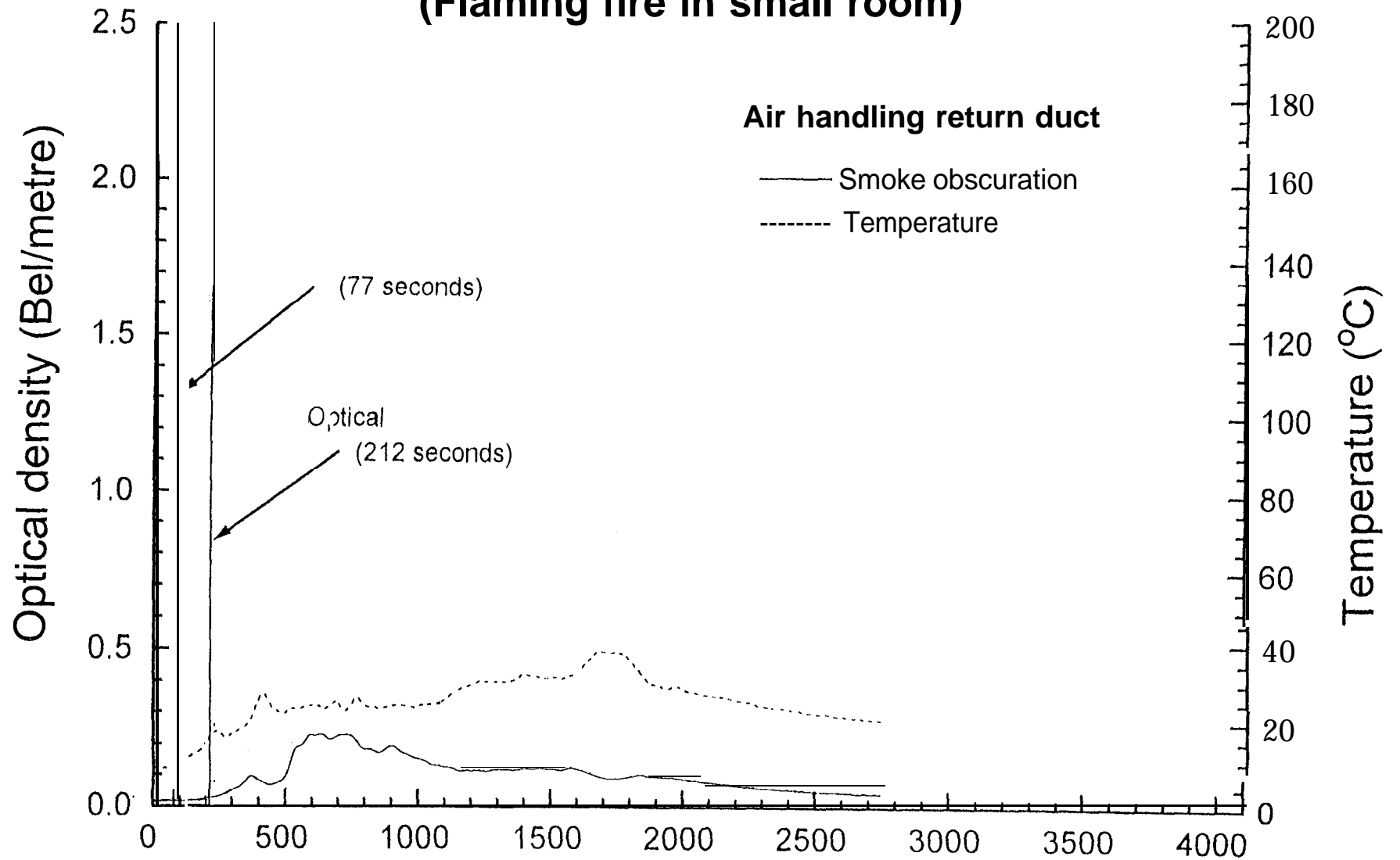

Fig. 7.3.7-14
Smoke, obscuration and temperature - Test FMS7
(Flaming fire in small room)

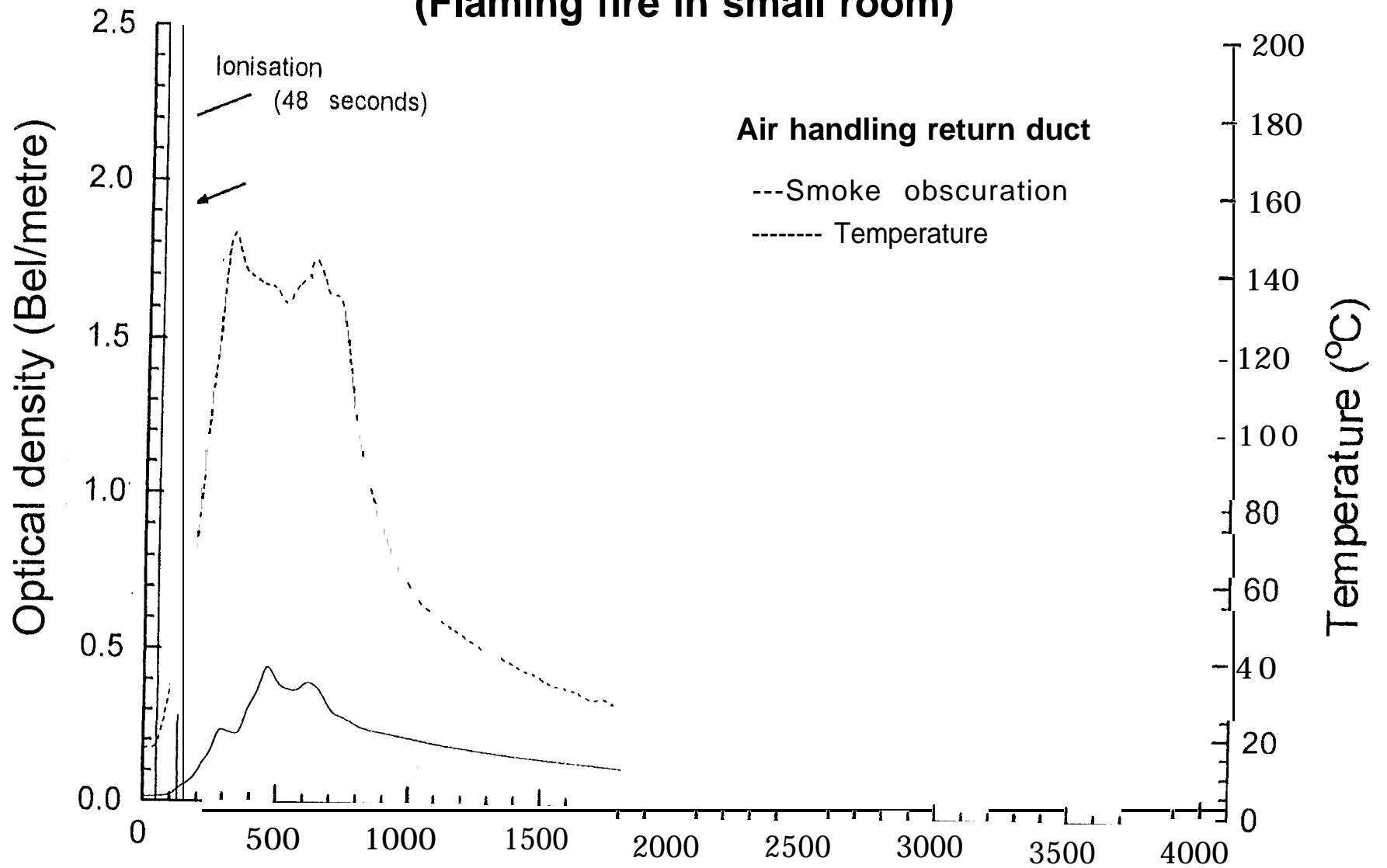

Fig. 8.1 .1-1

Commercial product tests (Flaming fire in large room)

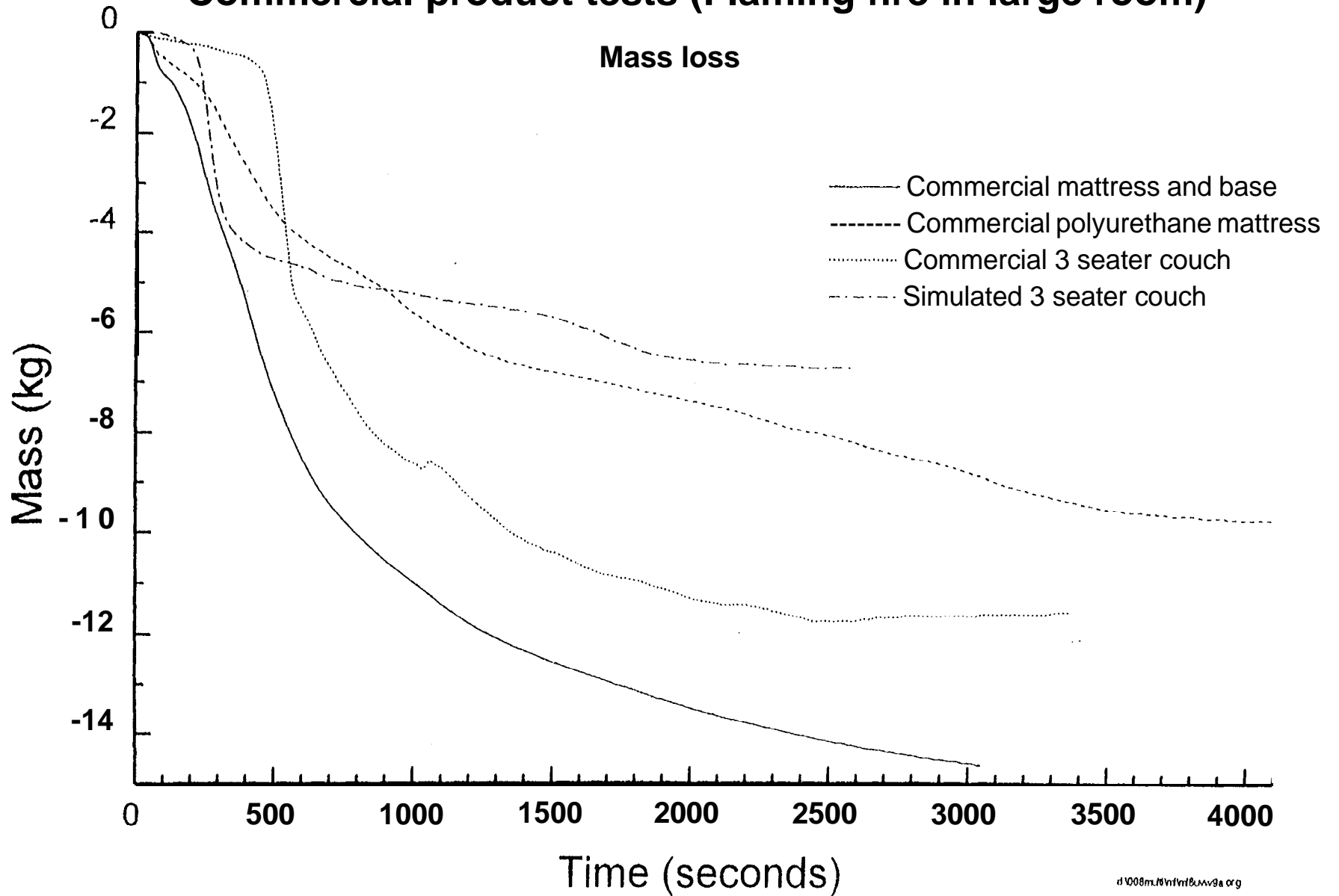

Fig. 8.1.2-I

Commercial product tests (Flaming fire in large room)

Carbon monoxide concentration at 1800mm high in room 102 doorway

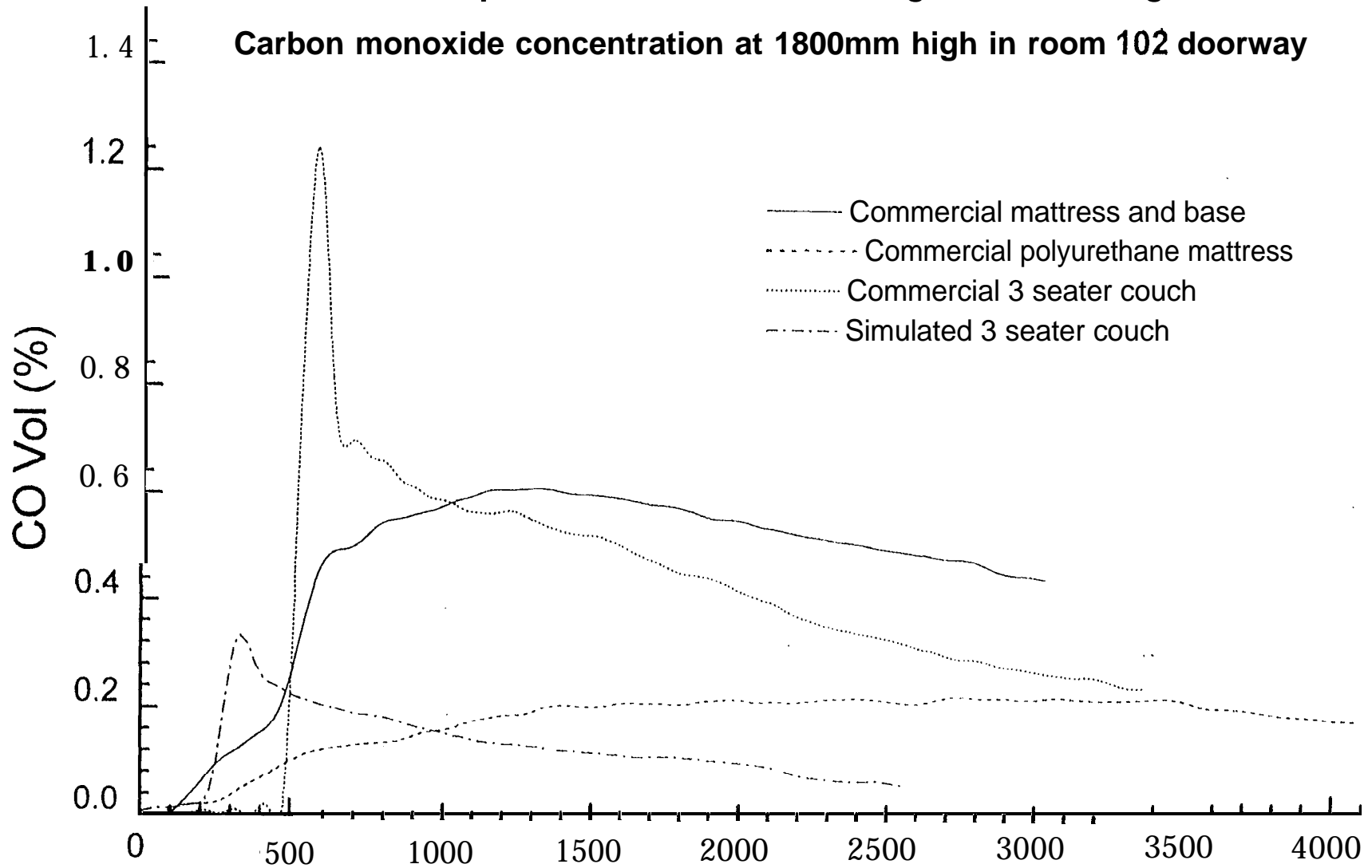

Fig. 8.1.3-I
Commercial product tests (Flaming fire in large room)

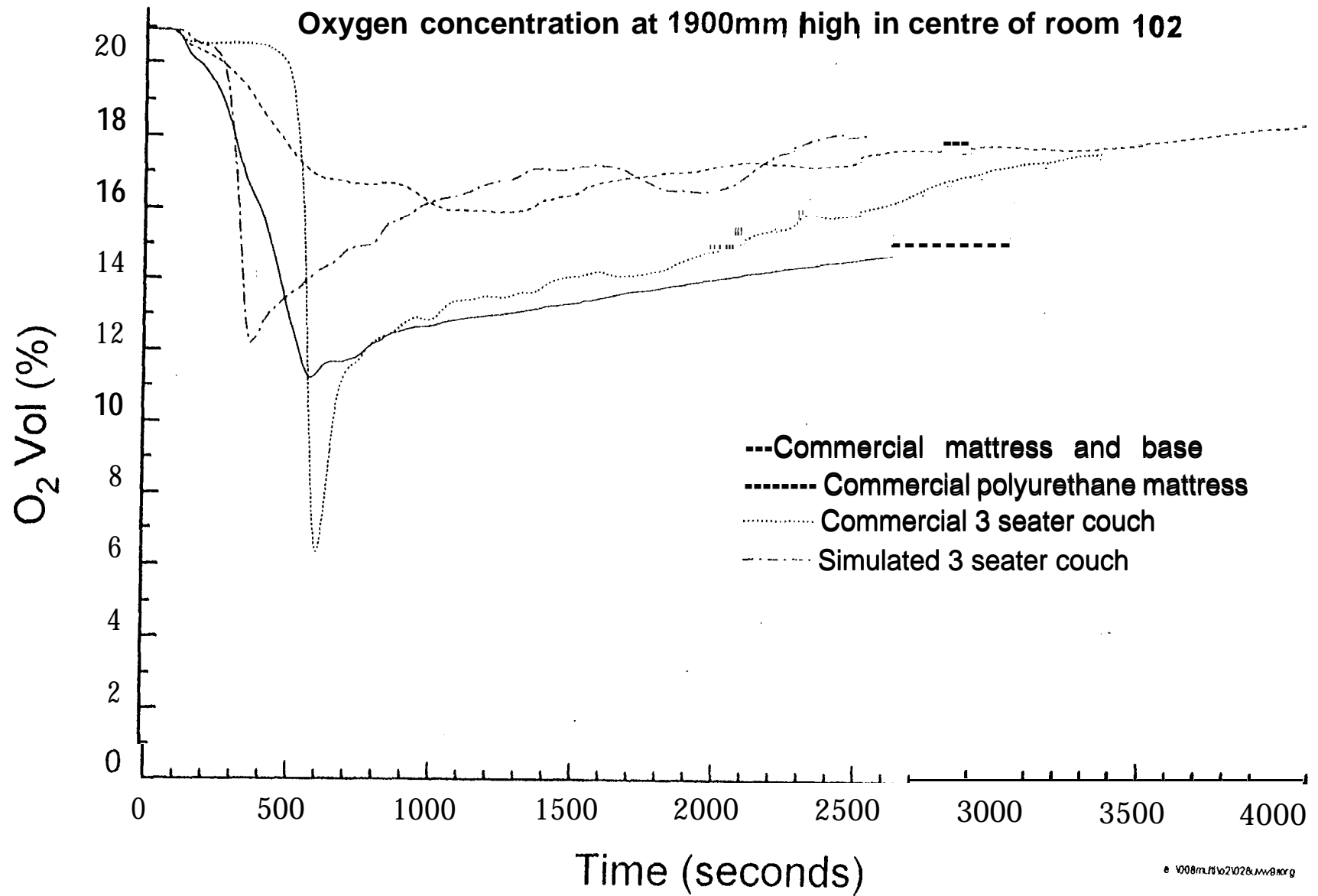

Fig. 8.1.4-I

Commercial product tests (Flaming fire in large room)

Average temperature in room 102/3

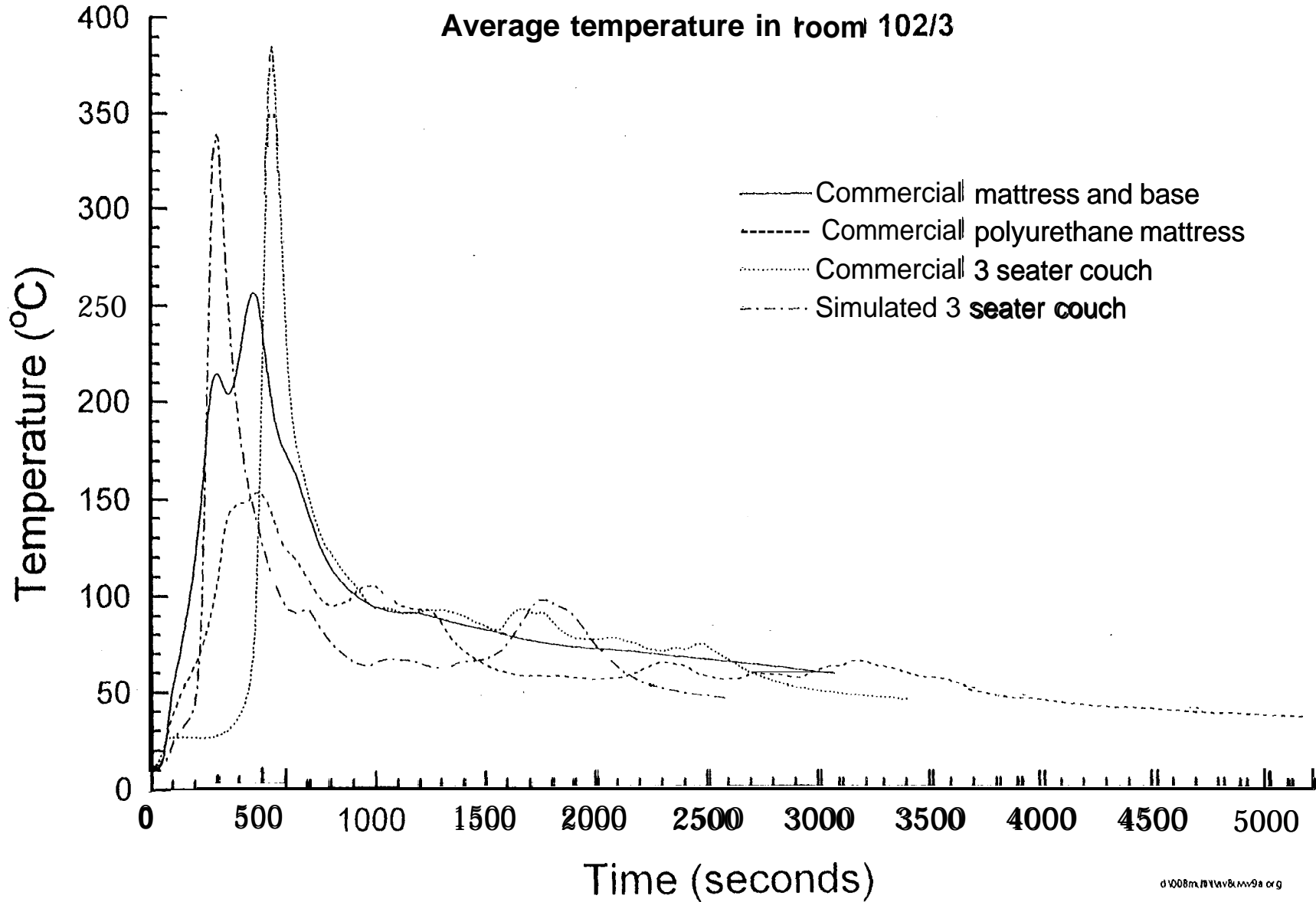

Fig. 8.2.1-I

Mass loss (Flaming fire in large room) - Test FML1

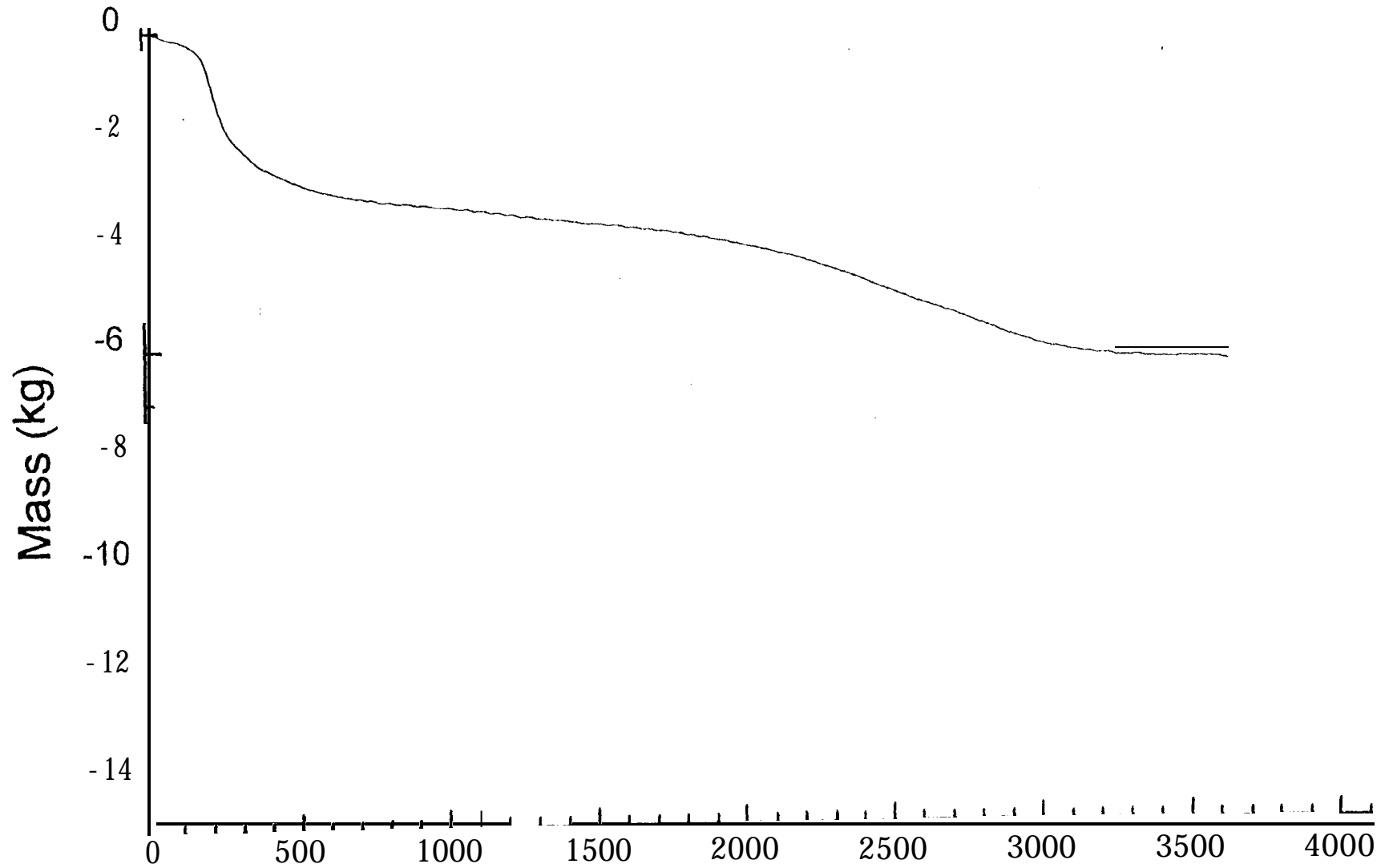

Fig. 8.2.1-2

Mass loss (Flaming fire in large room) - Test FML2

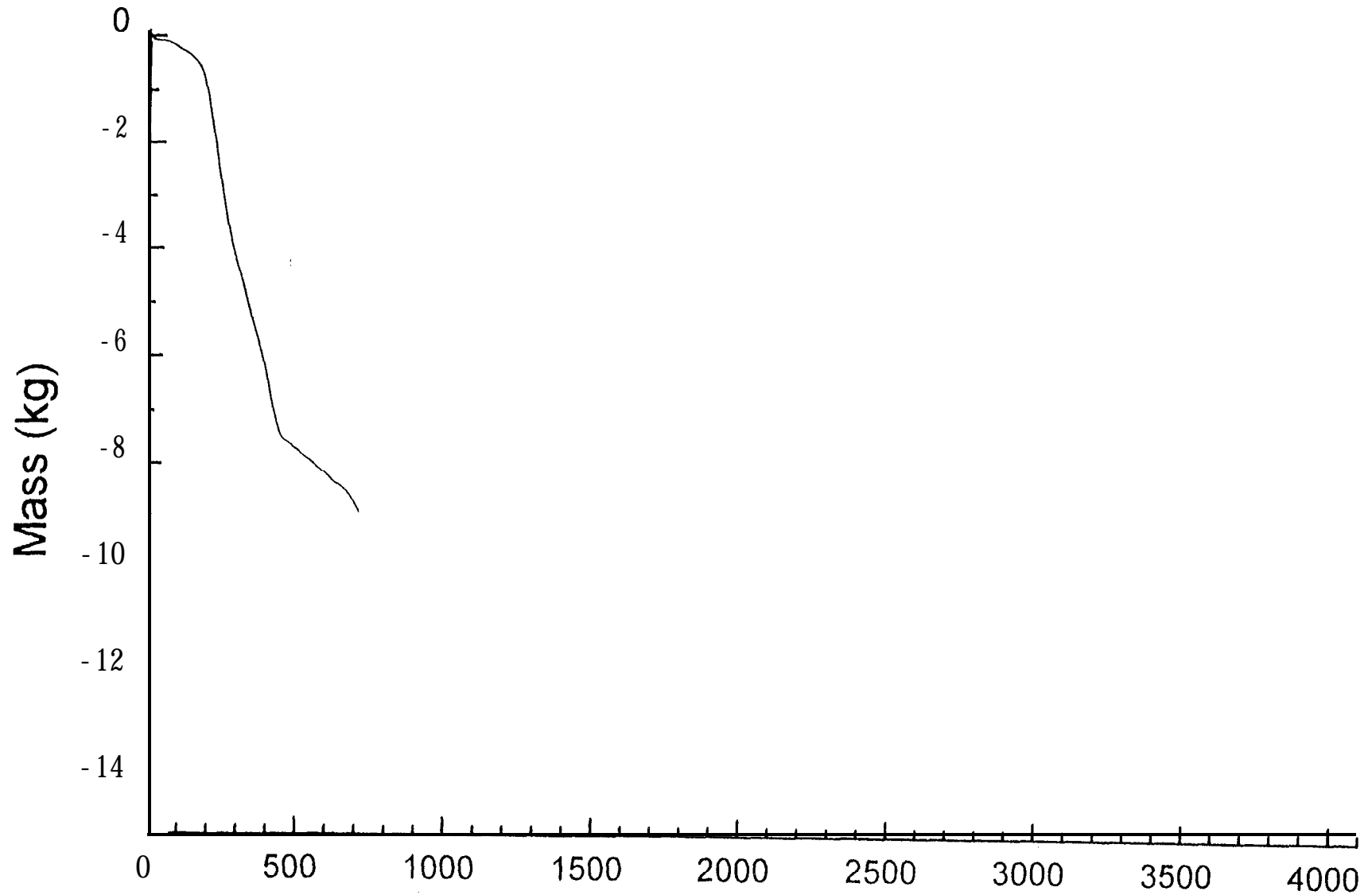

Fig. 8.2.1-3

Mass loss (Flaming fire in large room) - Test FML3

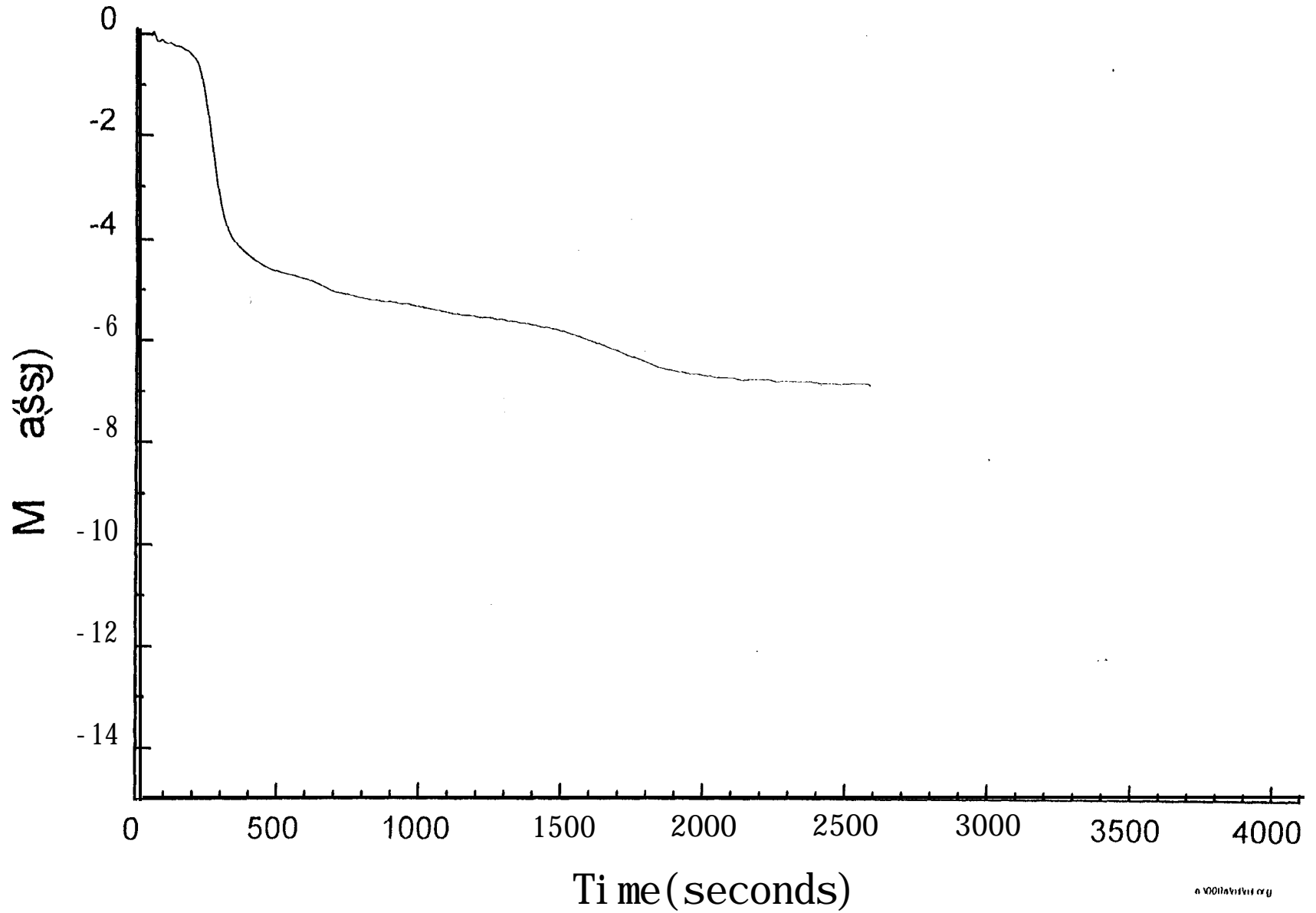

Fig. 8.2.1-4

Mass loss (Flaming fire in large room) - Test FML4

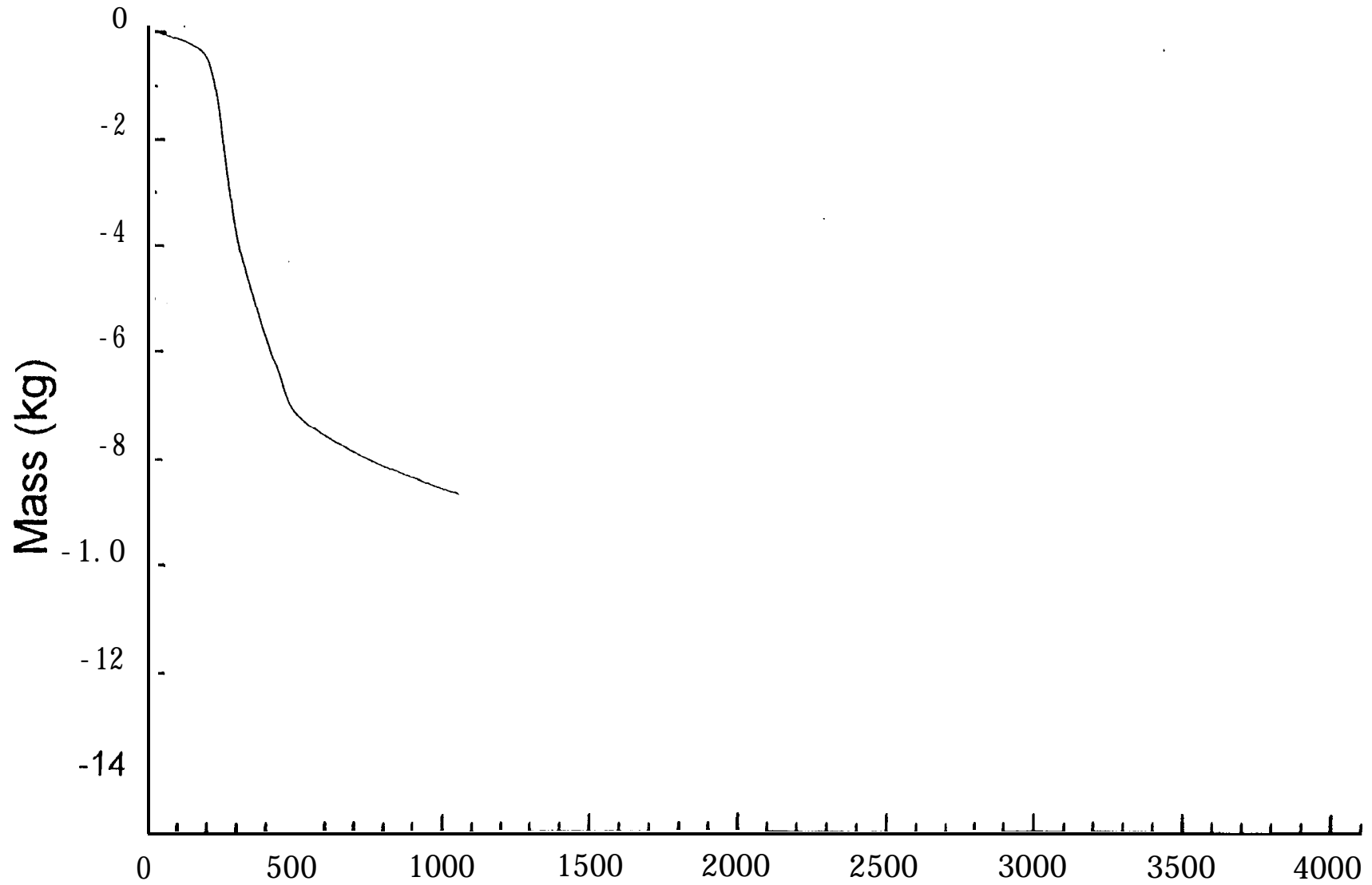

Fig. 8.2.1-5
Mass loss (Flaming fire in large room) - Test FML5

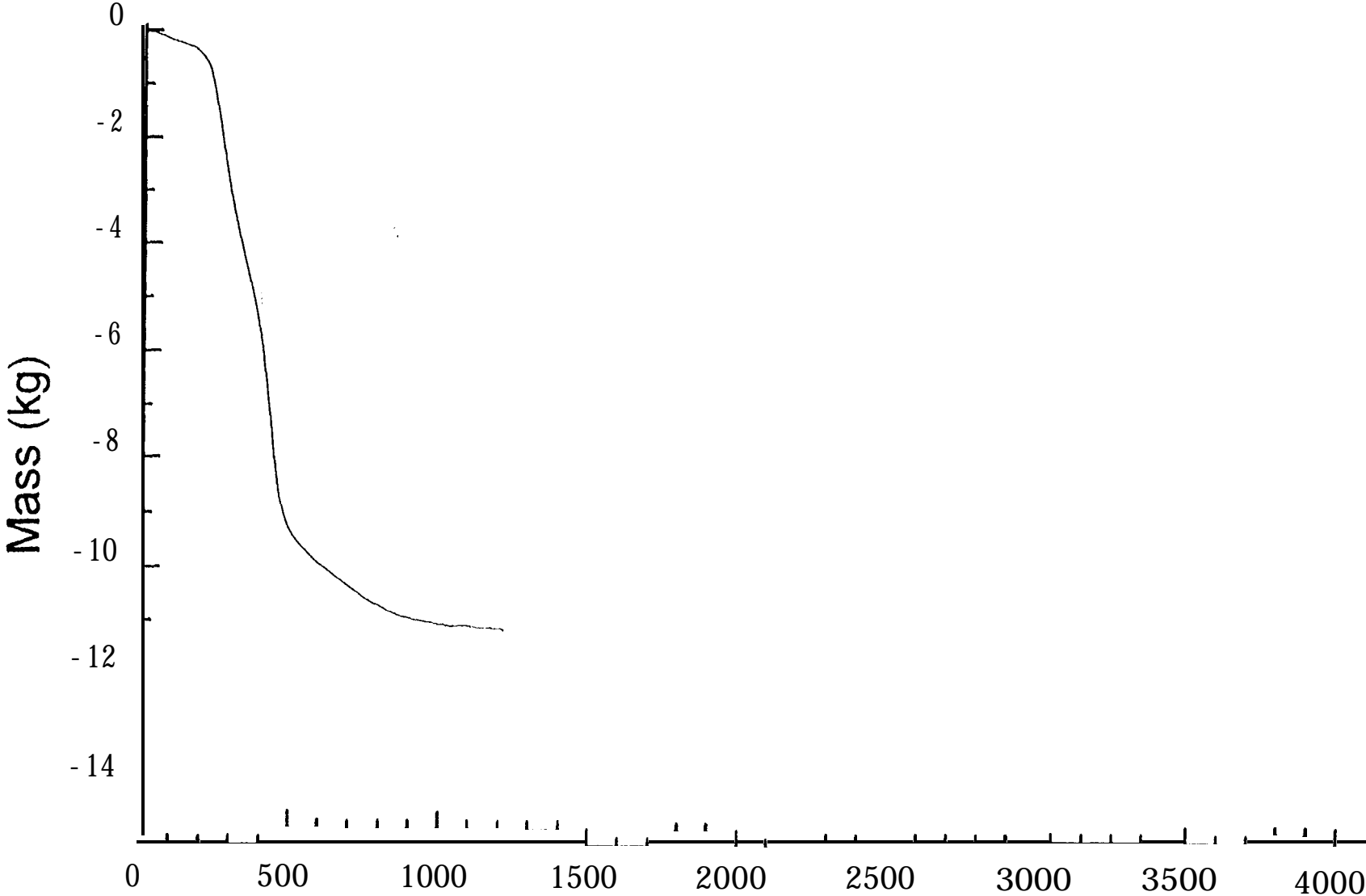

Fig. 8.2.1-6

Mass loss (Flaming fire in large room) - Test FML6

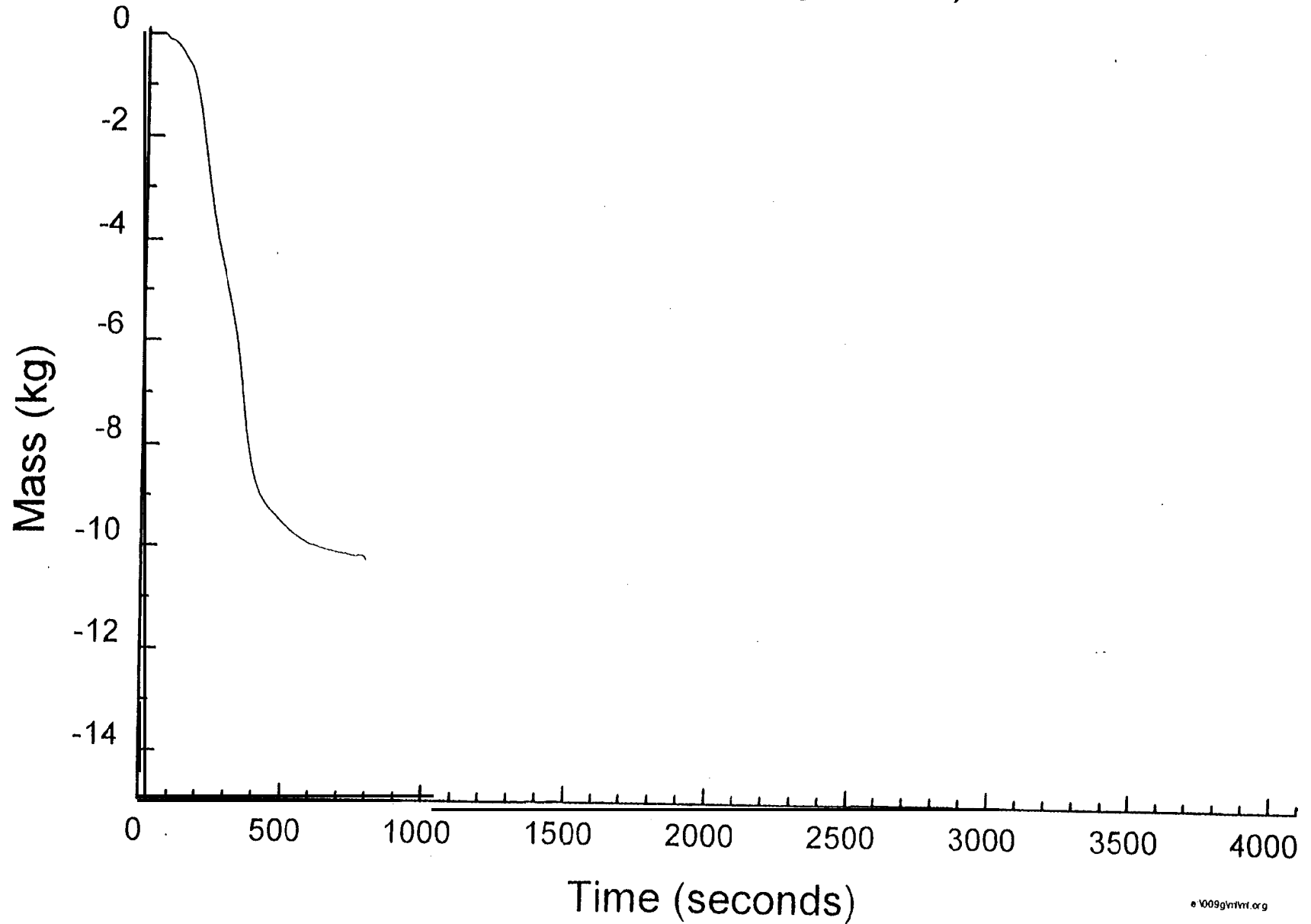

Fig. 8.2.1-7

Mass loss (Flaming fire in large room) - Test FML7

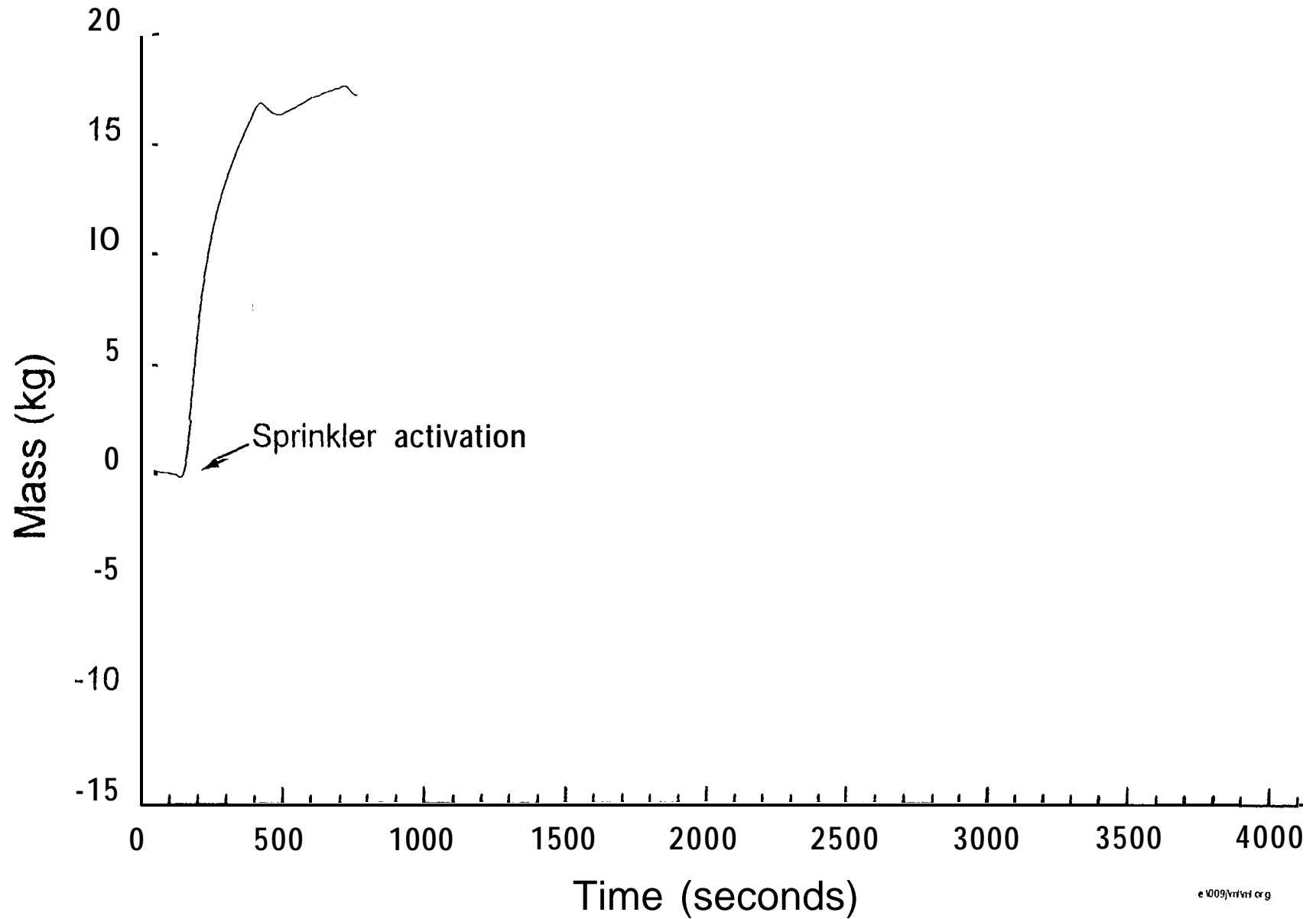

Fig. 8.2.2-I

Average room temperatures (Flaming fire in large room) - Test FML1

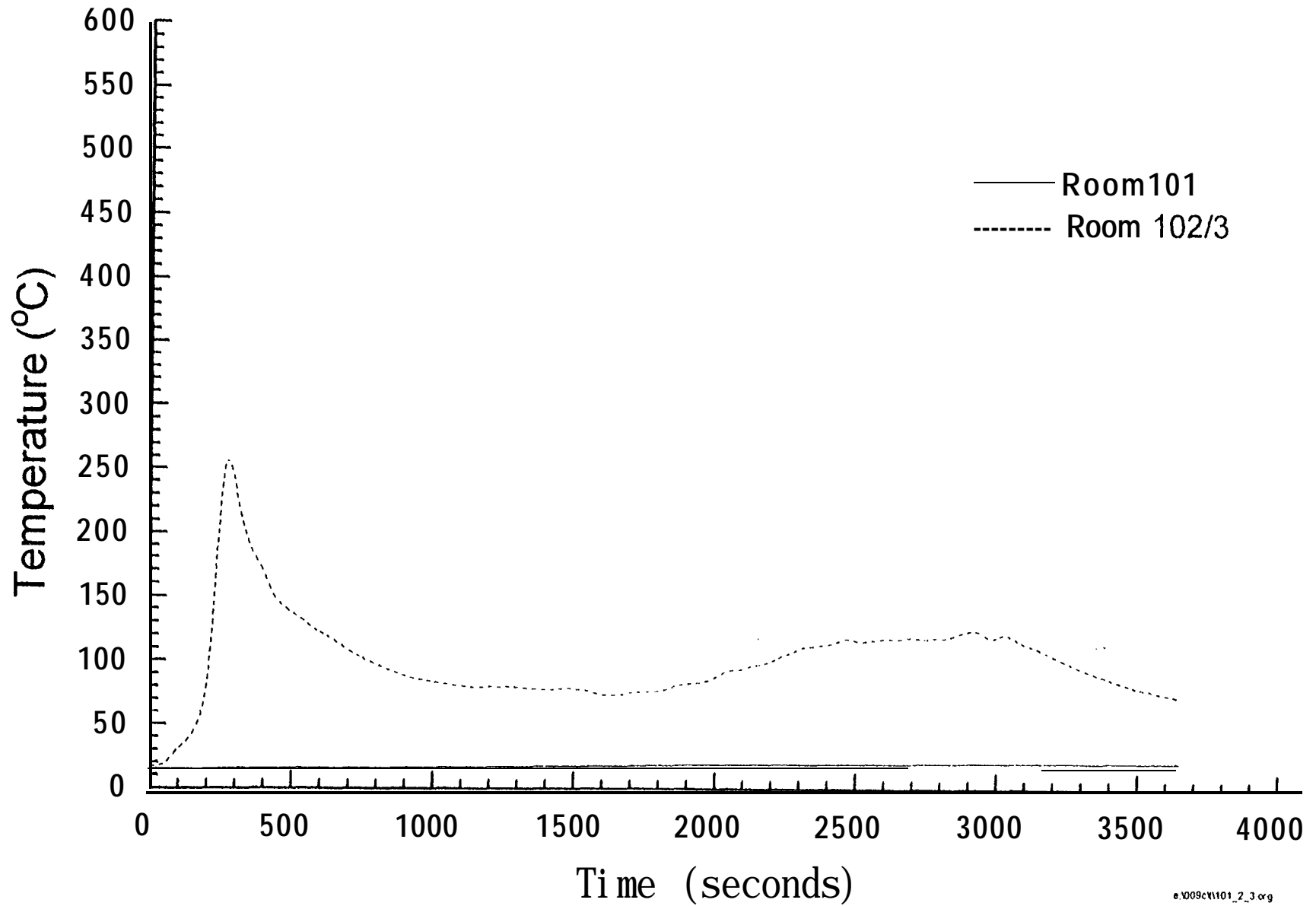

Fig. 8.2.2-2

Average room temperatures (Flaming fire in large room) - Test FML2

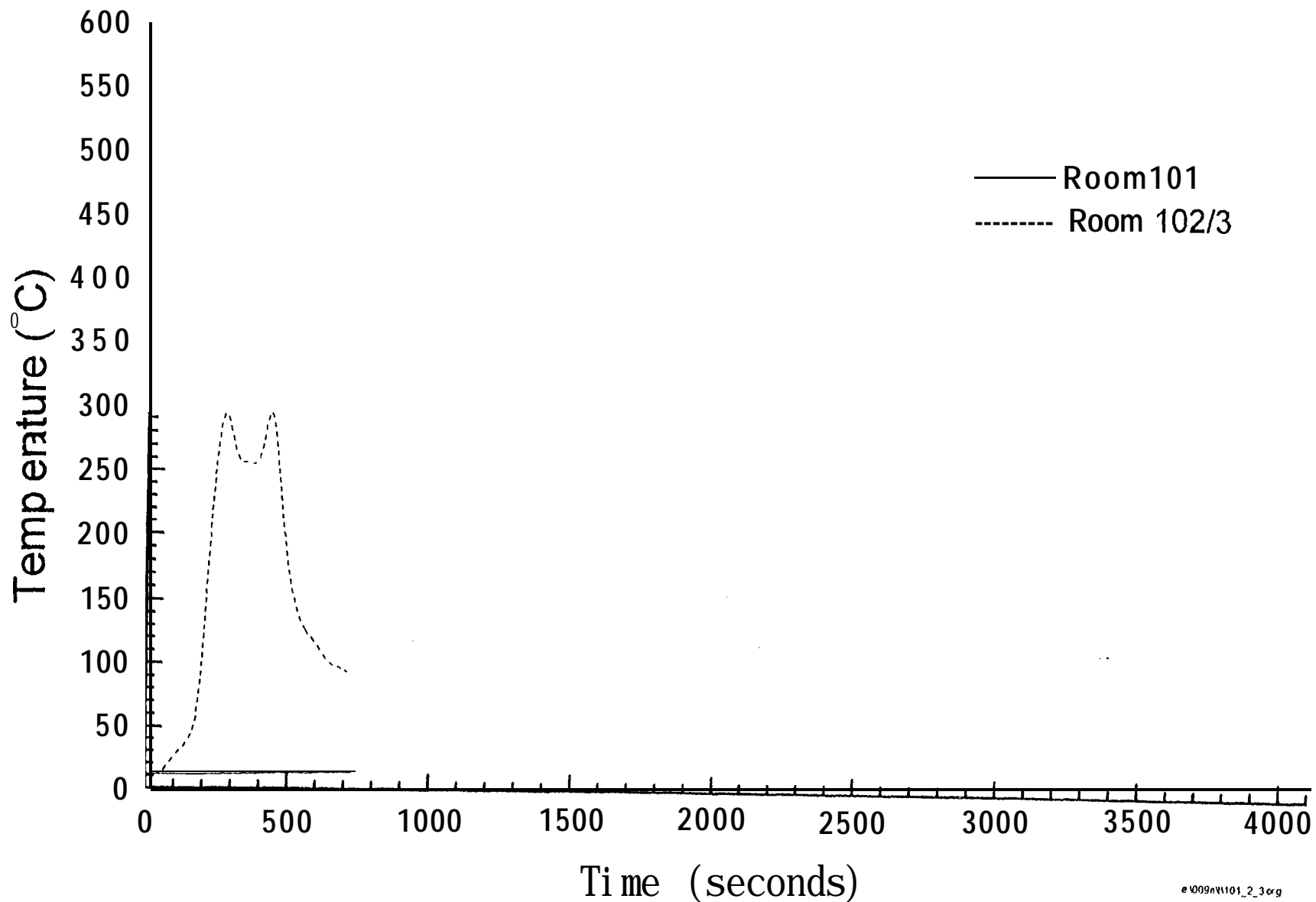

Fig. 8.2.2-3

Average room temperatures (Flaming fire in large room) - Test FML3

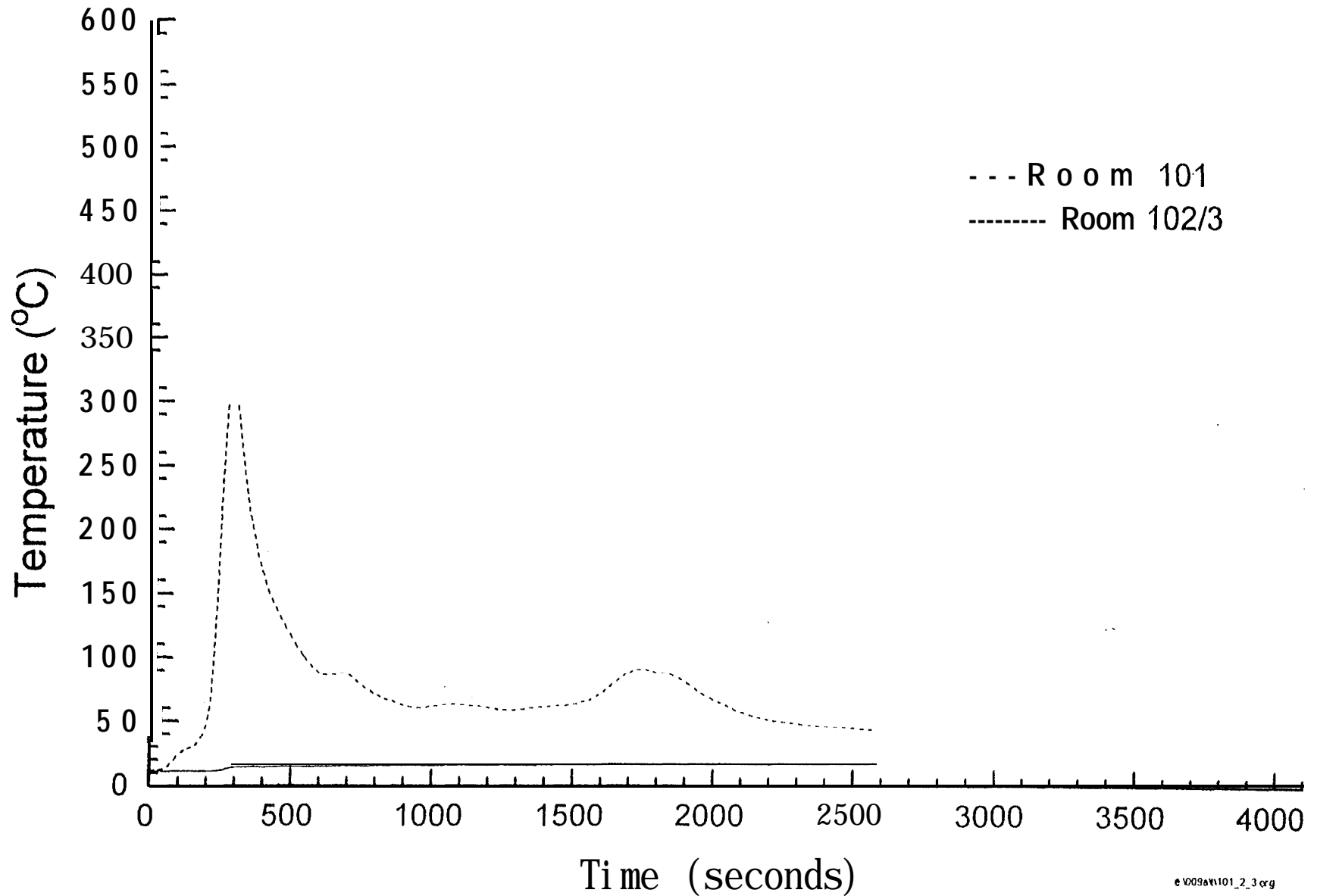

Fig. 8.2.2-4

Average room temperatures (Flaming fire in large room) - Test FML4

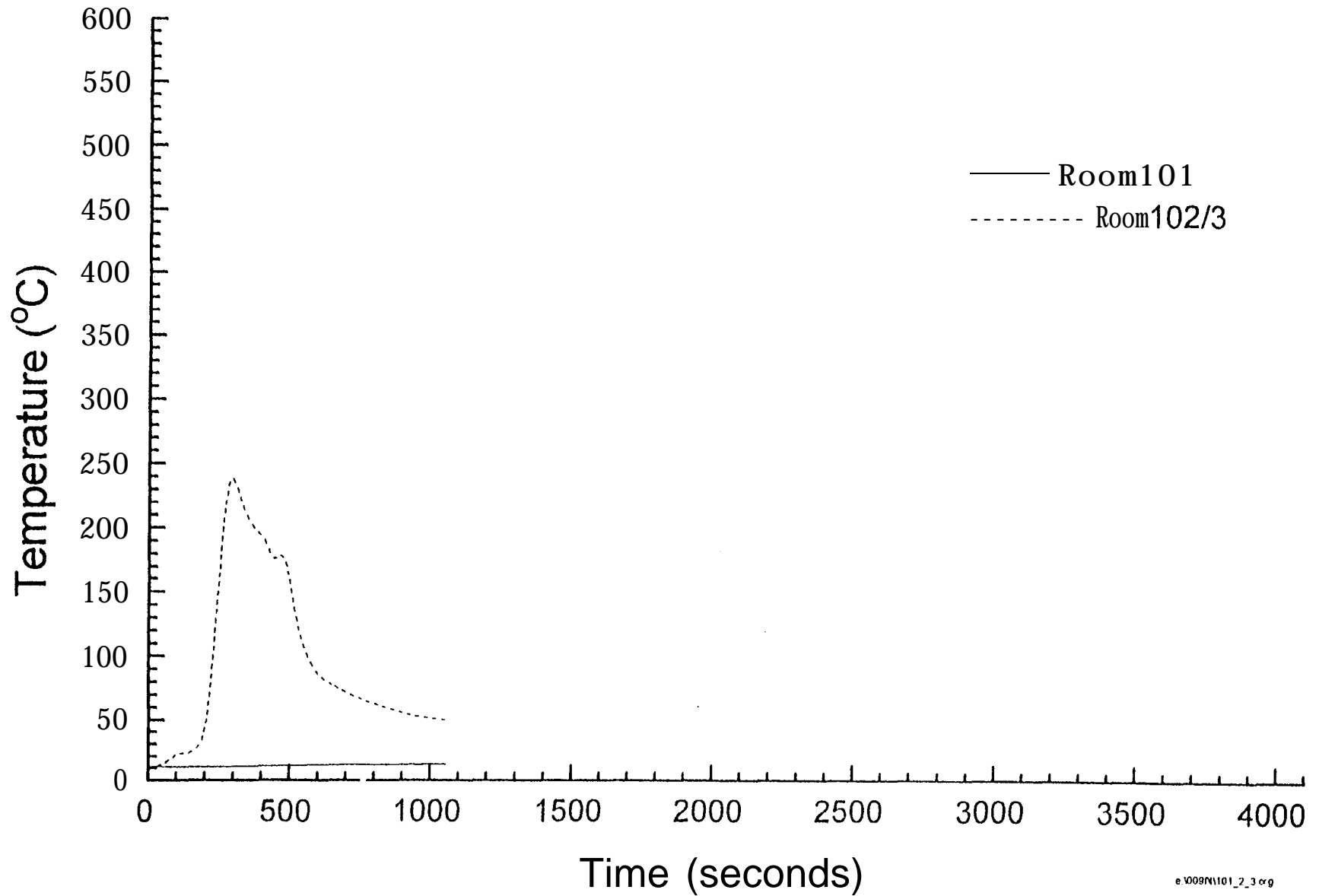

Fig. 8.2.2-5

Average room temperatures (Flaming fire in large room) - Test FML5

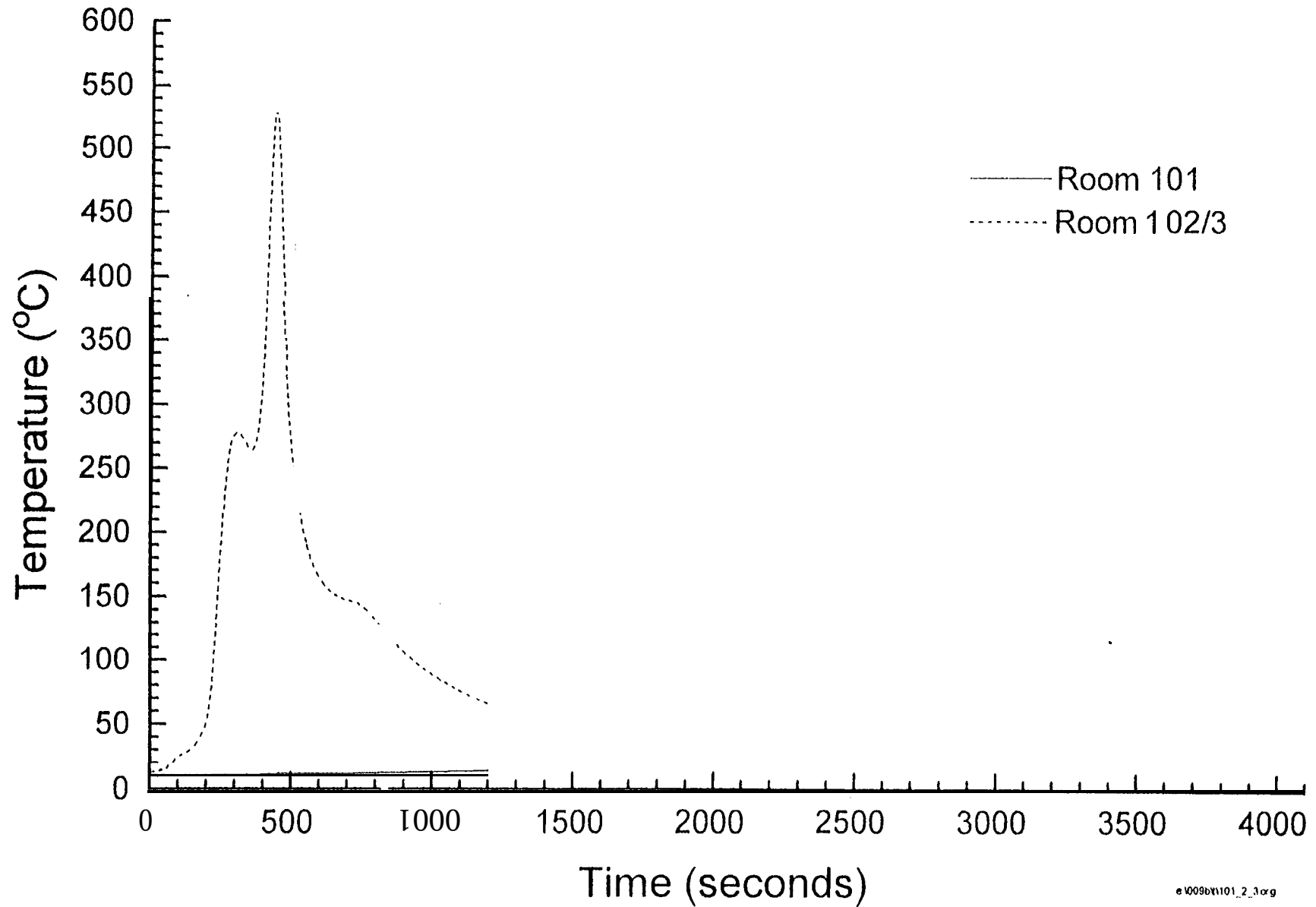

Fig. 8.2.2-6

Average room temperatures (Flaming fire in large room) - Test FML6

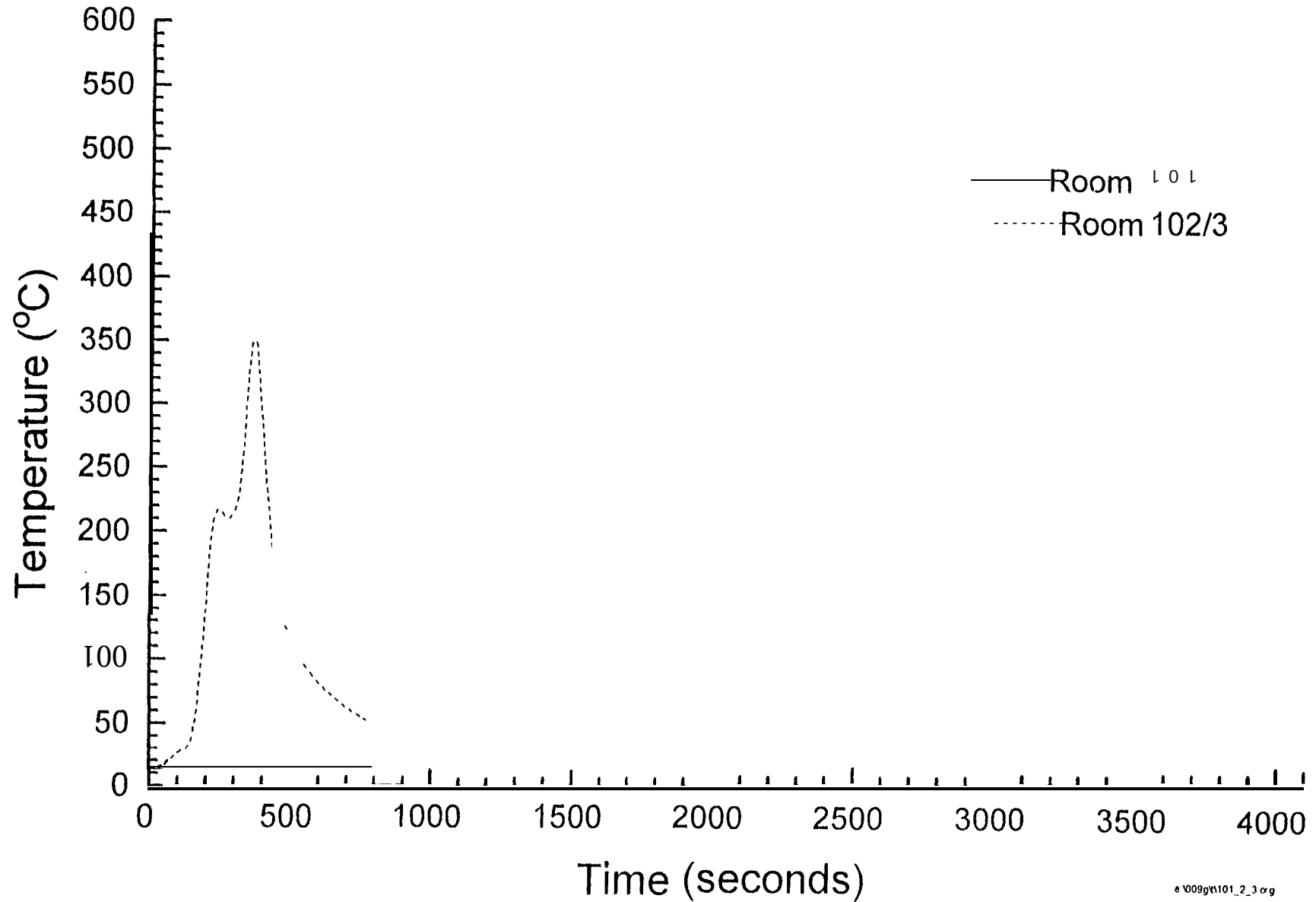

Fig. 8.2.2-7

Average room temperatures (Flaming fire in large room) - Test FML7

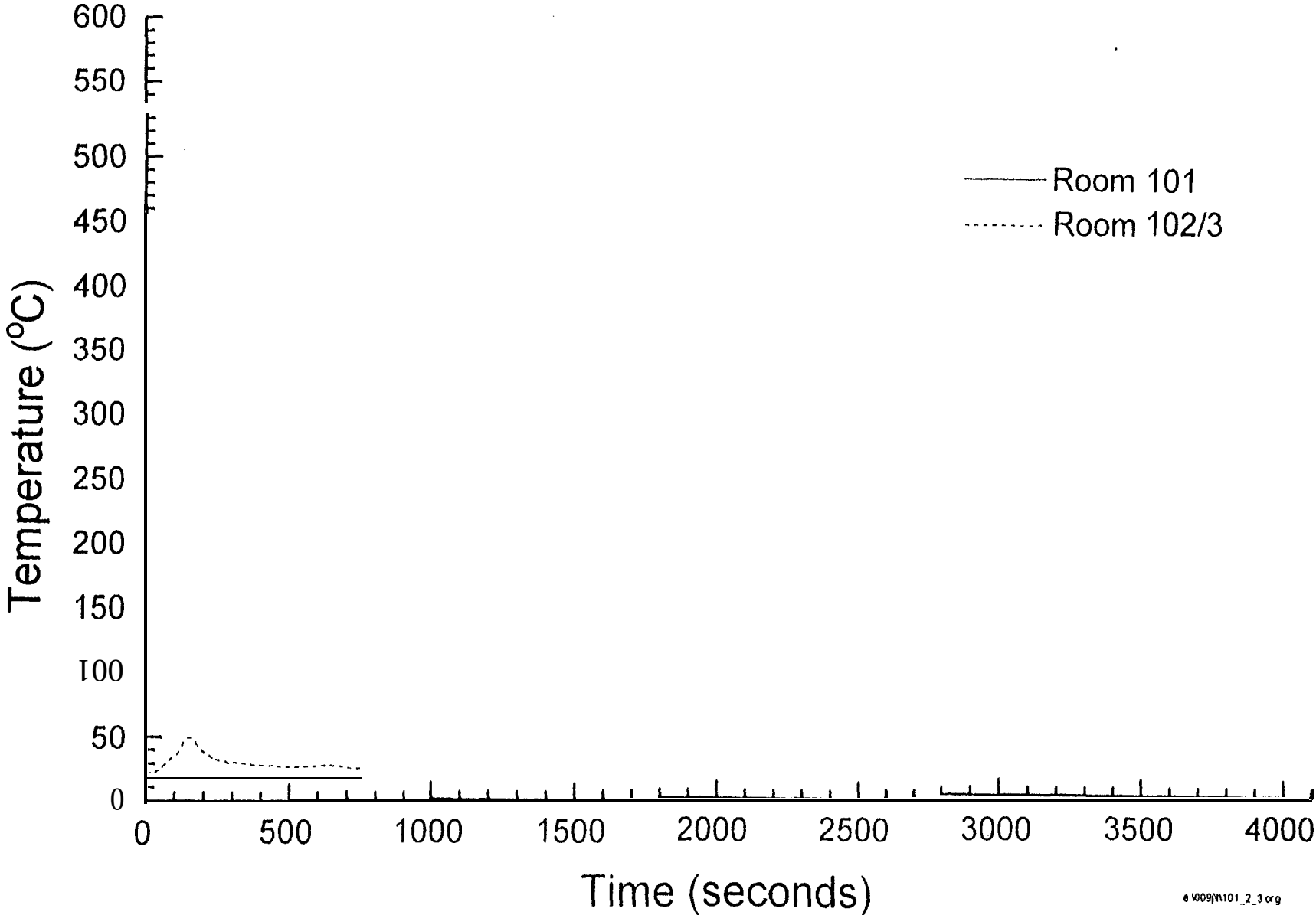

Fig. 8.2.3-1

Temperatures along corridor (Flaming fire in large room) - Test FML1

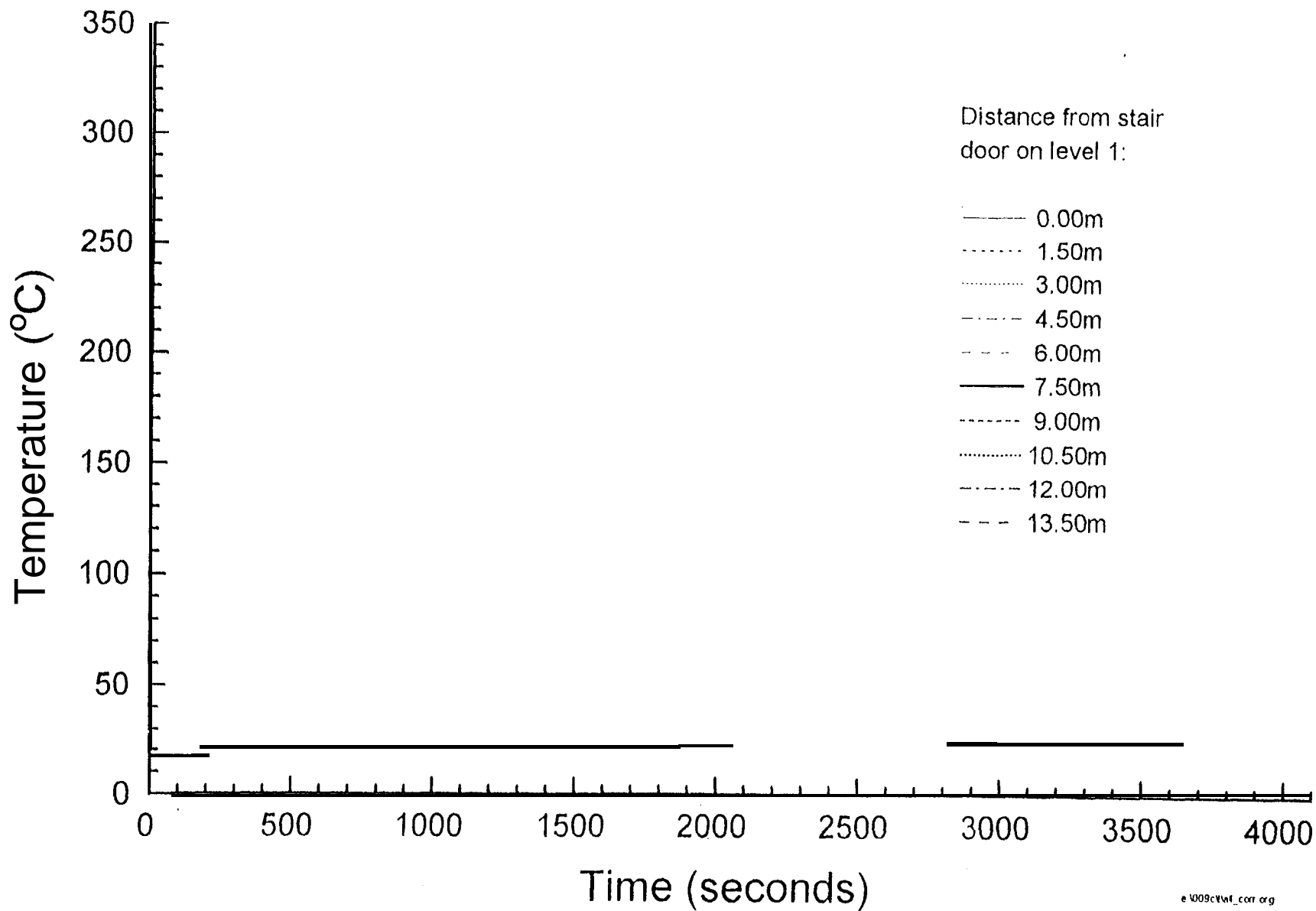

Fig. 8.2.3-2

Temperatures along corridor (Flaming fire in large room) - Test FML2

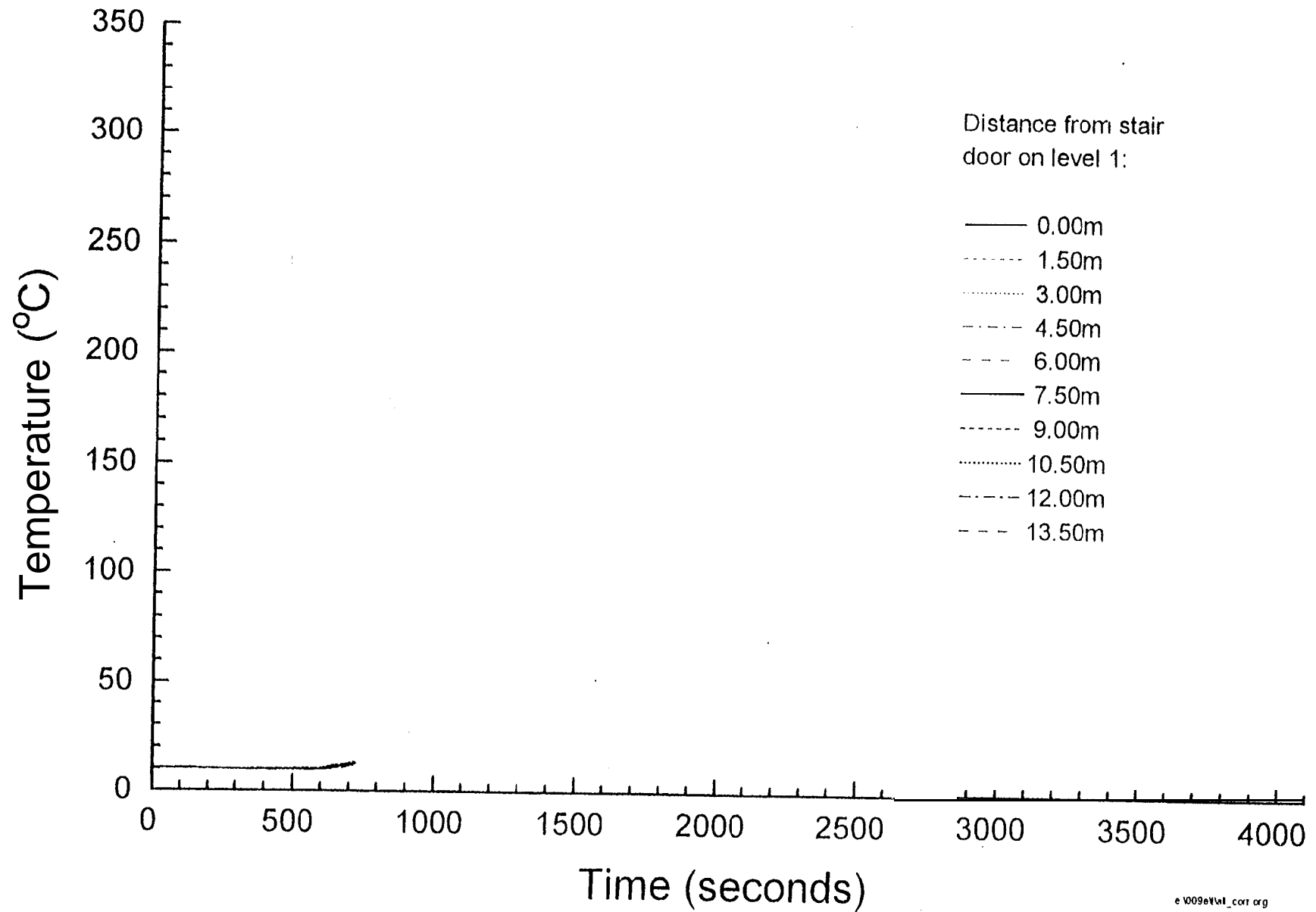

Fig. 8.2.3-3

Temperatures along corridor (Flaming fire in large room) - Test FML3

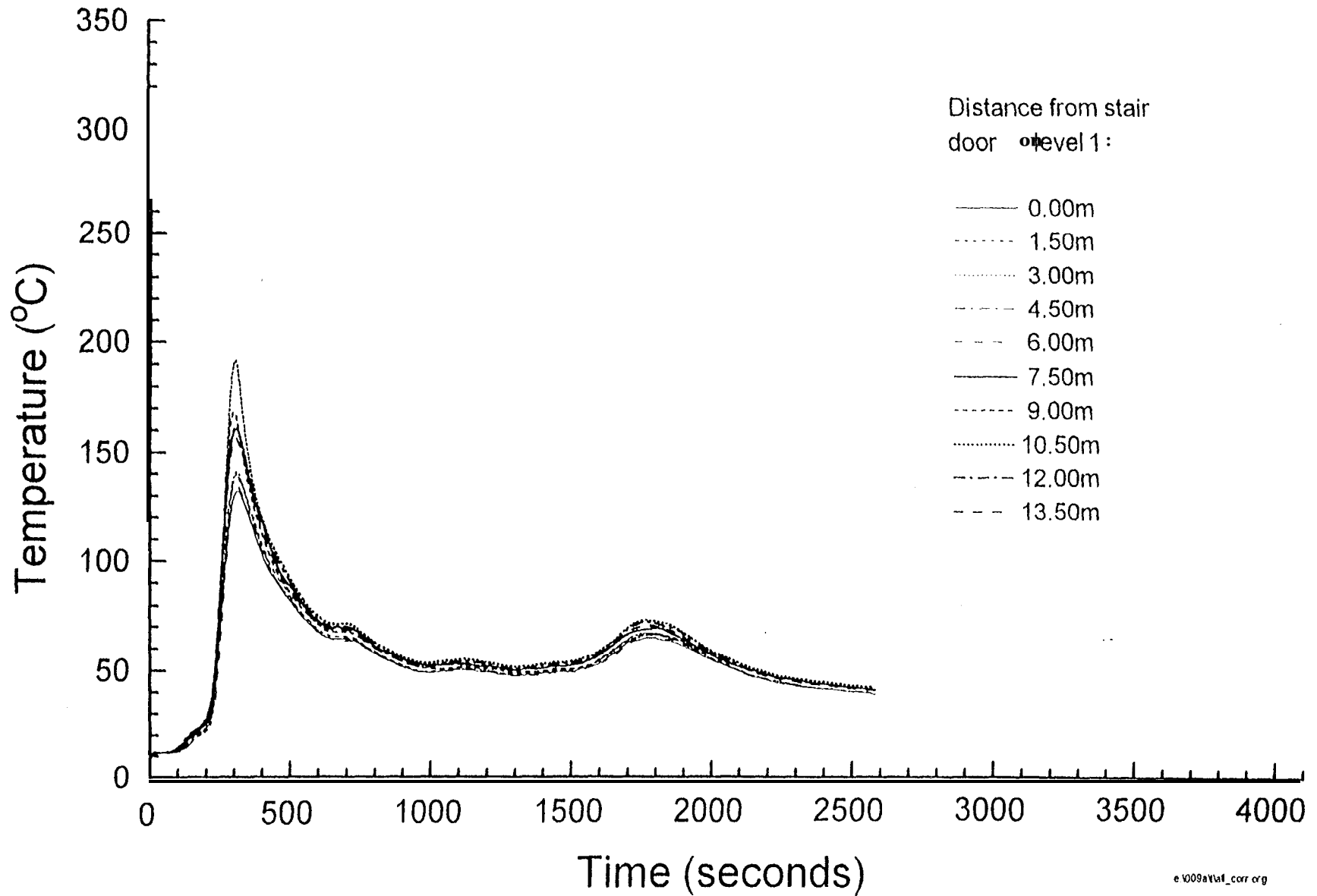

Fig. 8.2.3-4

Temperatures along corridor (Flaming fire in large room) - Test FML4

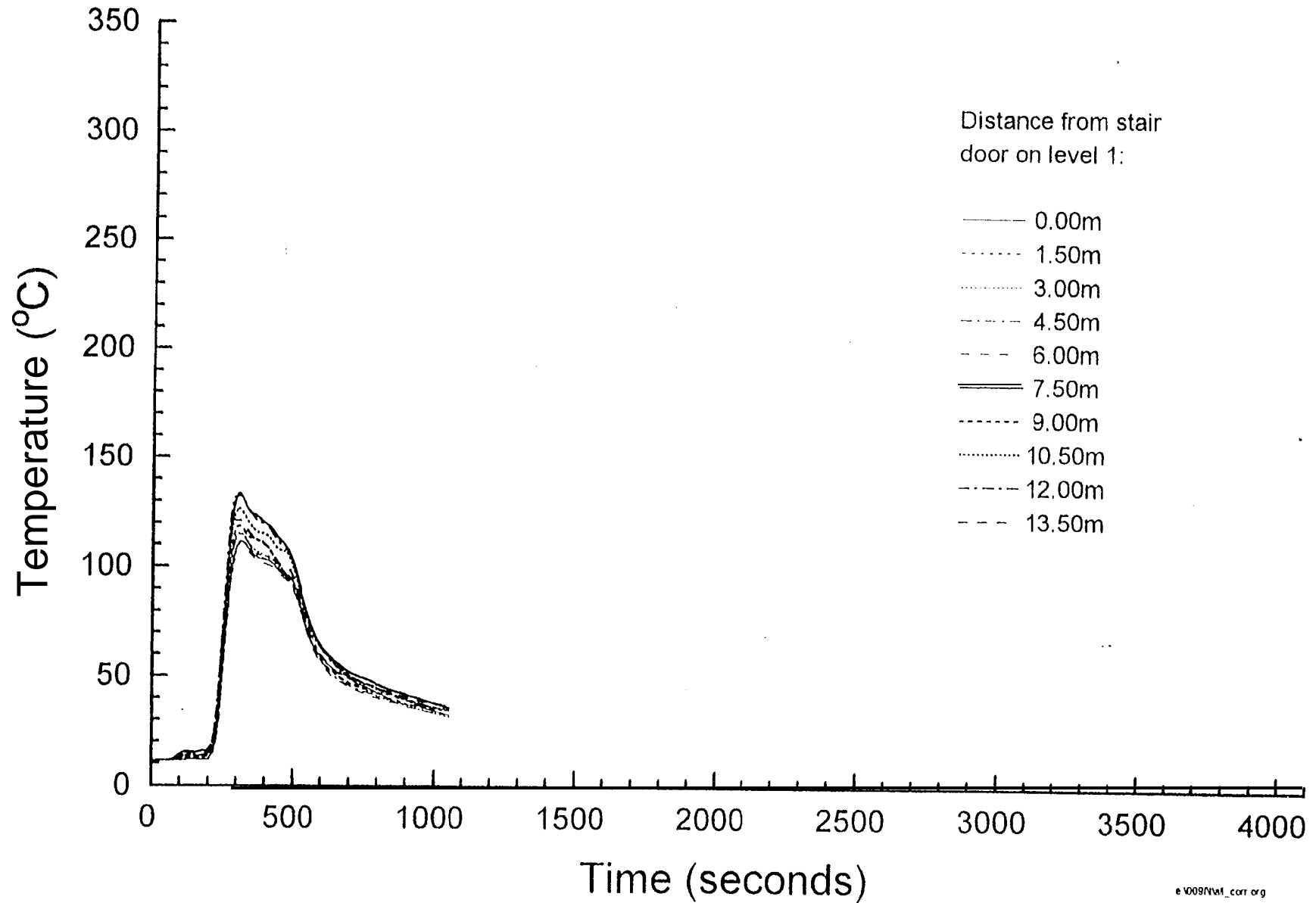

Fig. 8.2.3-5

(Flaming fire in large room) - Test FML5

Temperatures

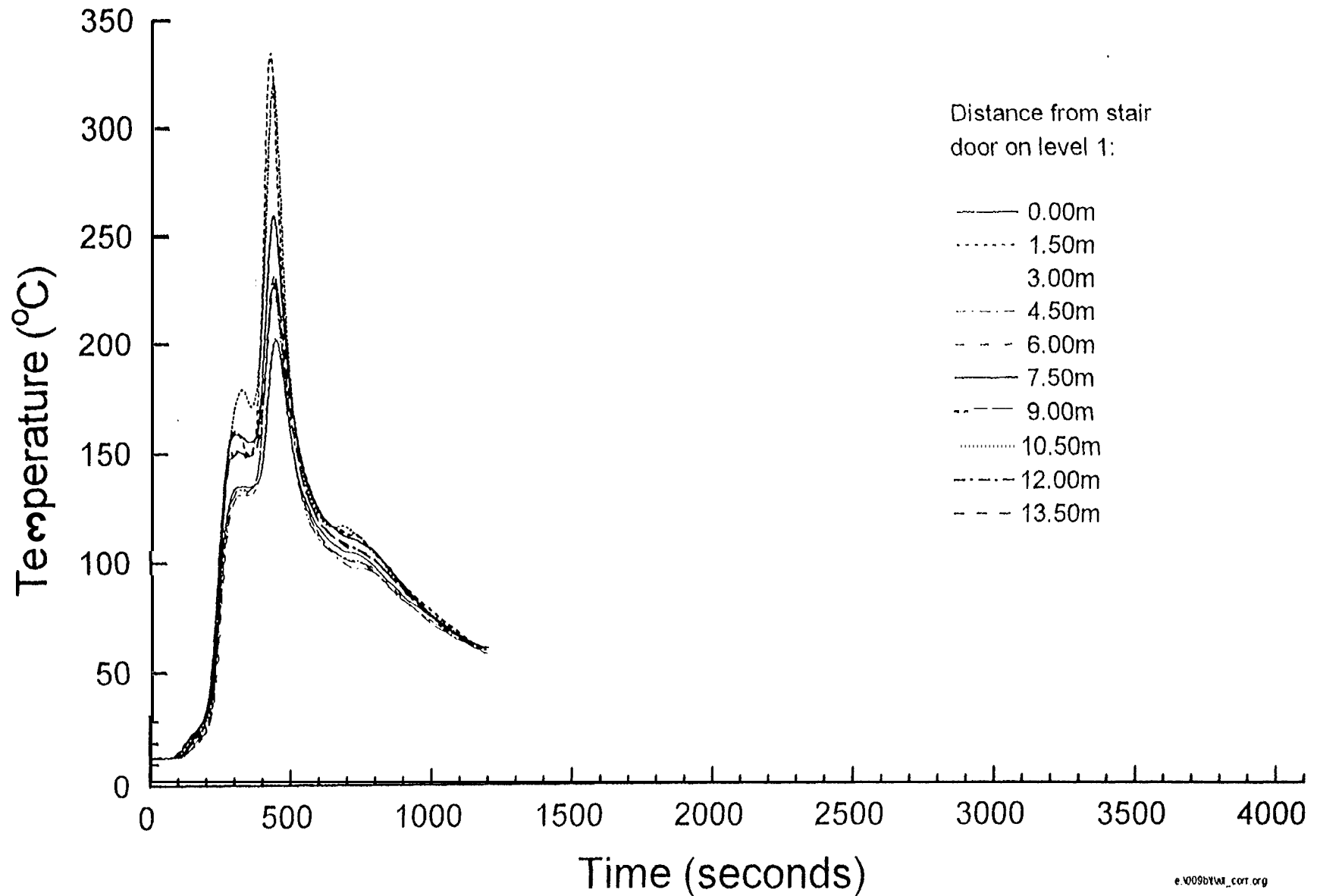

Fig. 8.2.3-6

Temperatures along corridor (Flaming fire in large room) - Test FML6

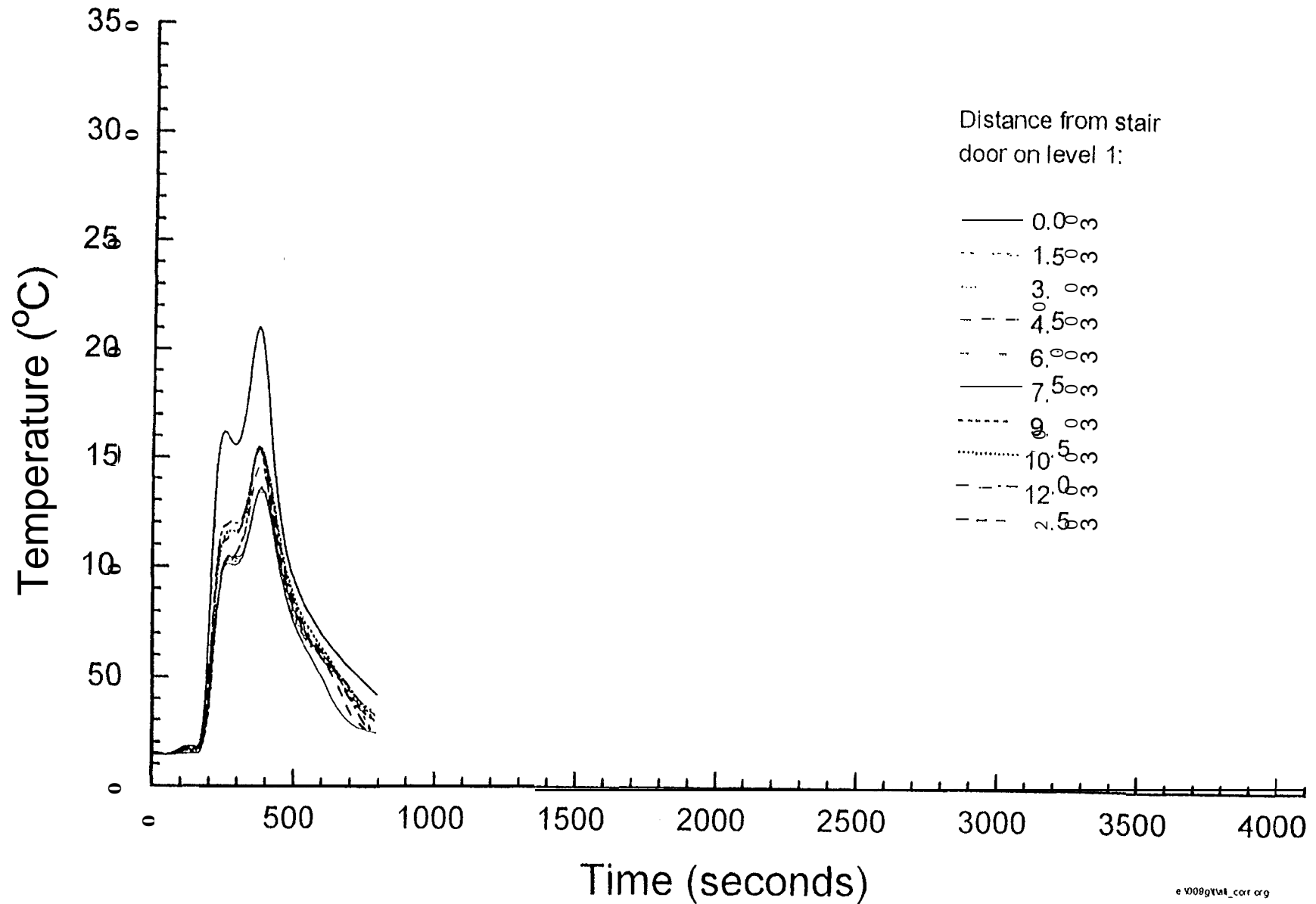

Fig. 8.2.4-I

Temperatures in stair doorway - level 3 (Flaming fire in large room)

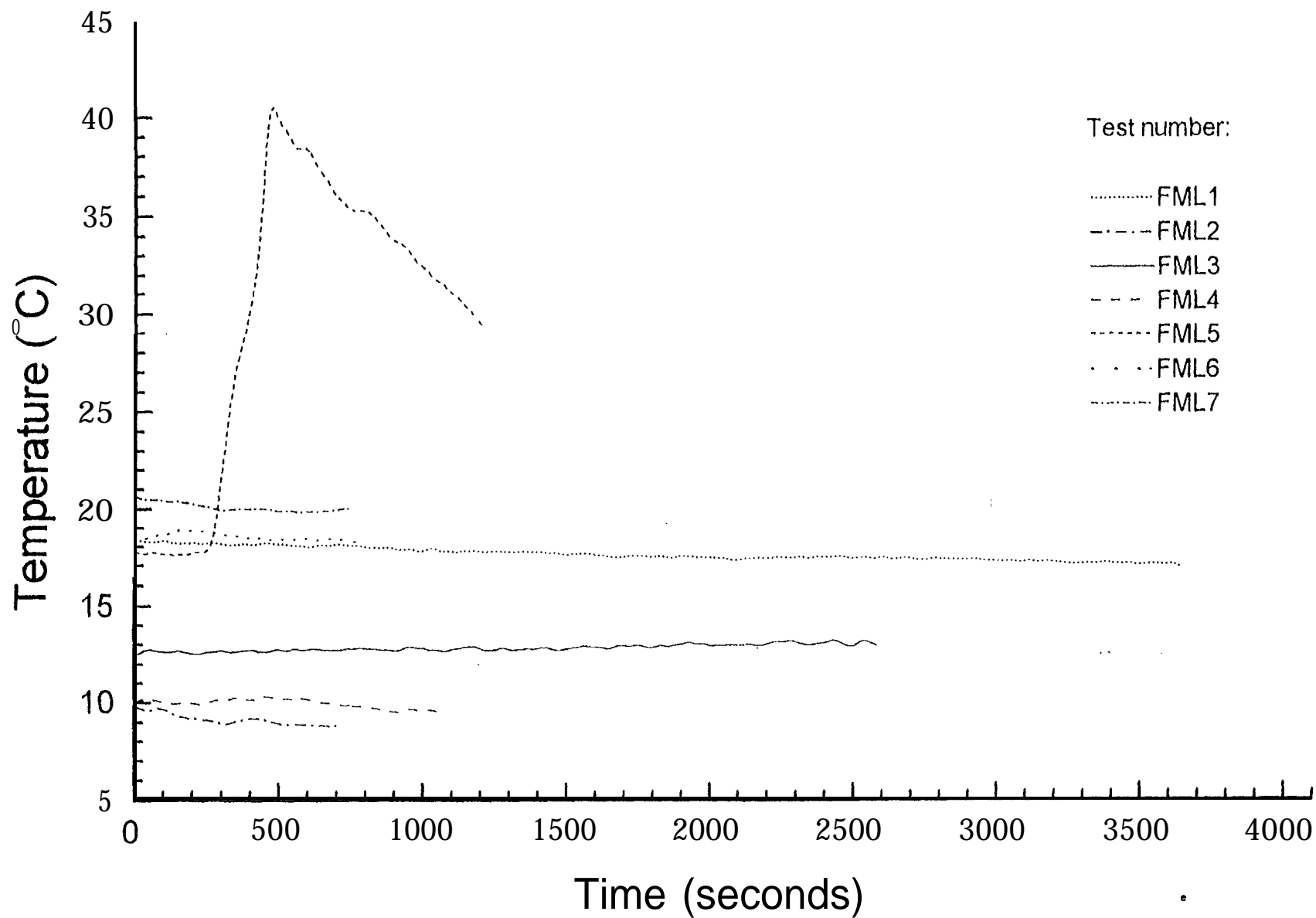

Fig. 8.2.5-

Radiative heat flux (Flaming fire in large room) - Test FML1

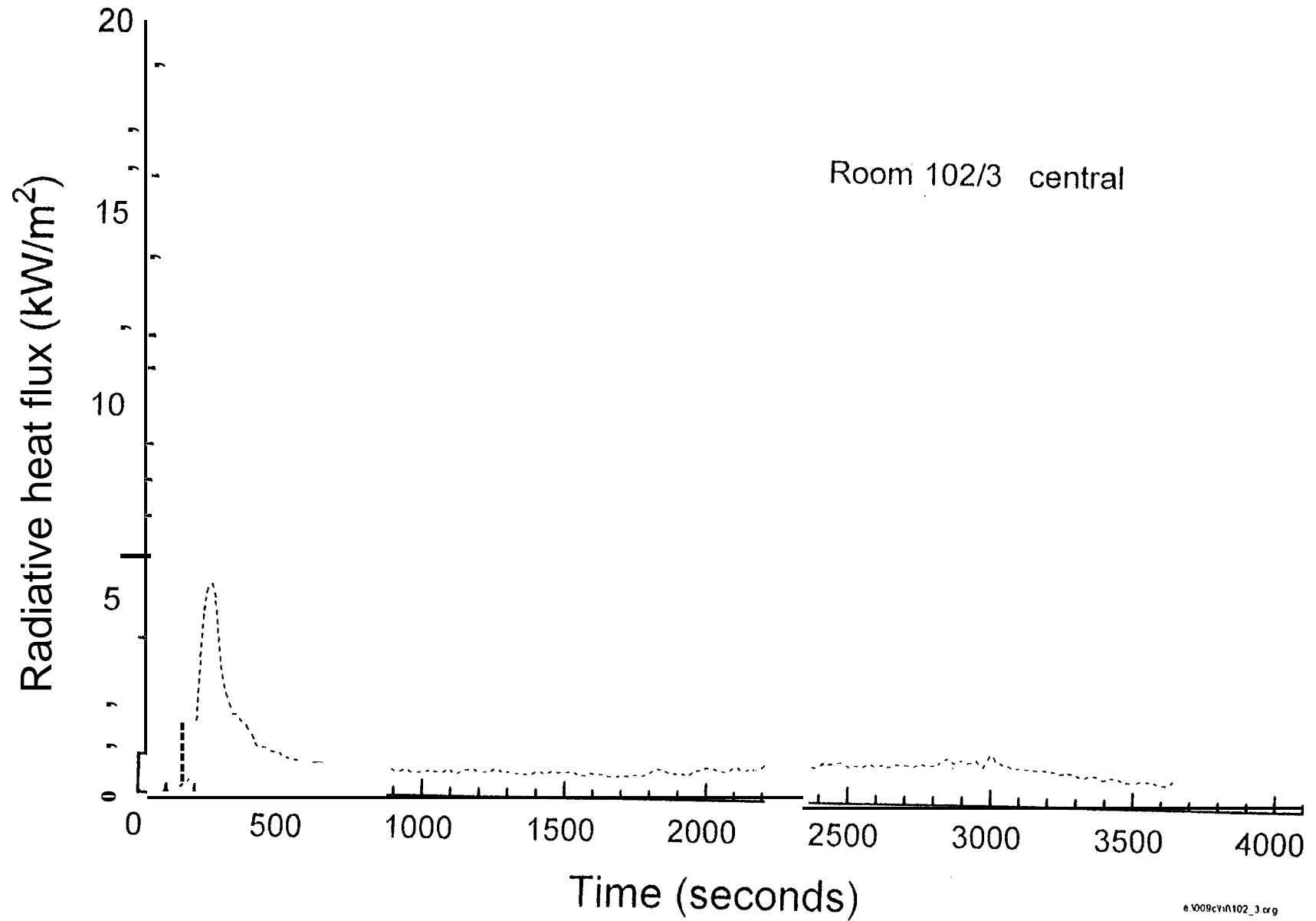

Fig. 8.2.5-2

Radiative heat flux (Flaming fire in large room) - Test FML2

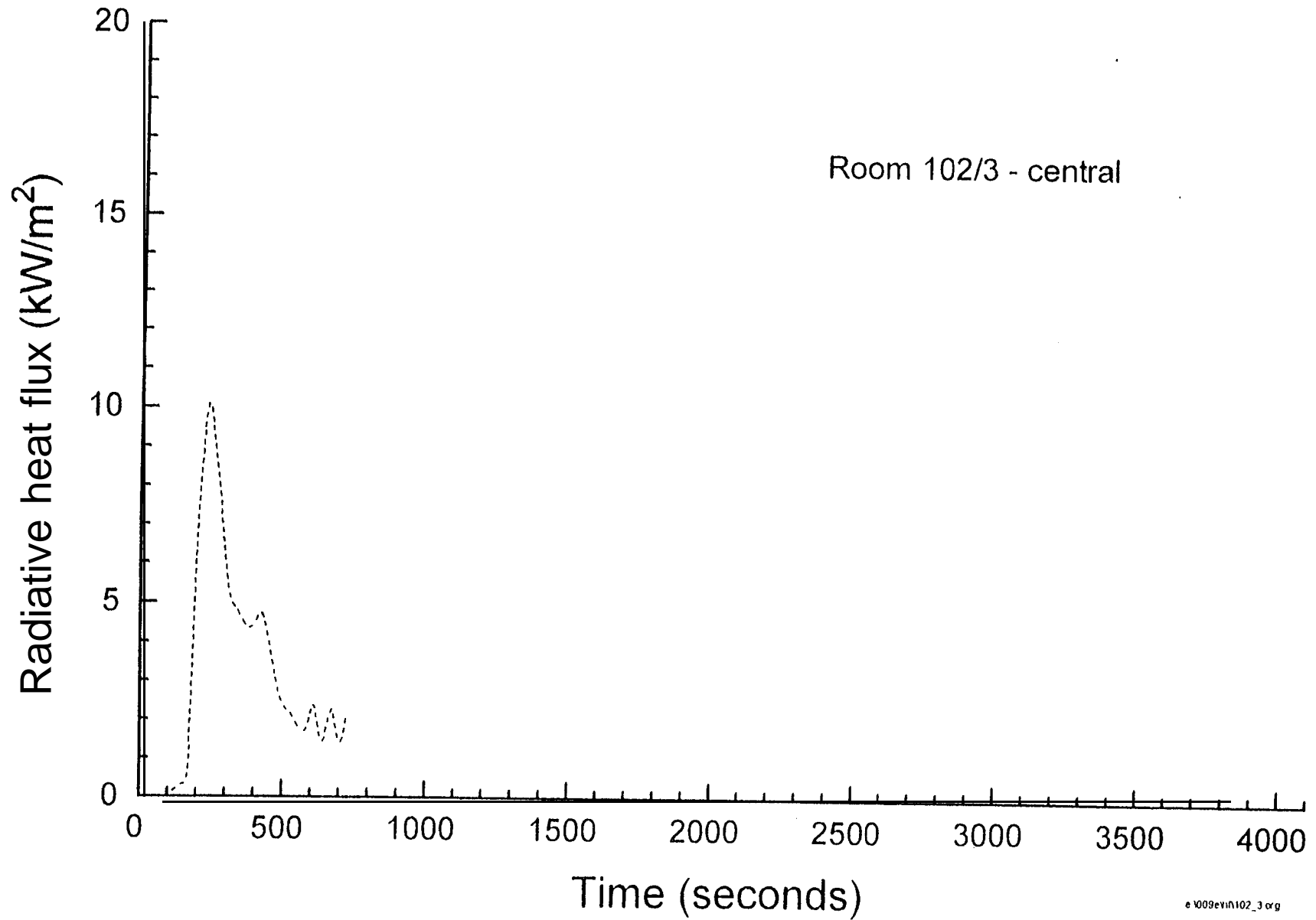

Fig. 8.2.5-3

Radiative heat flux (Flaming fire in large room) - Test FML3

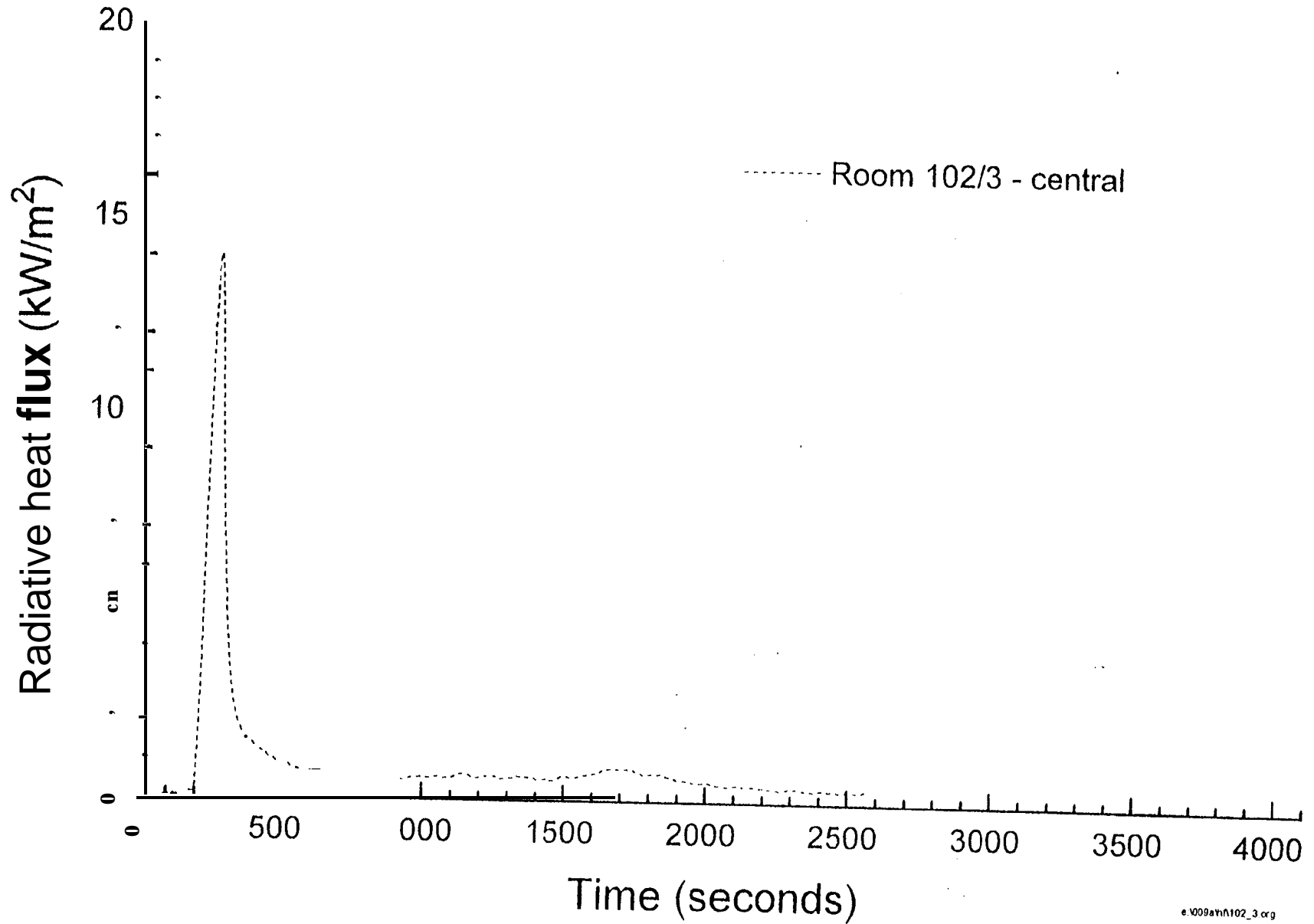

Fig. 8.2.5-4

Radiative heat flux (Flaming fire in large room) - Test FML4

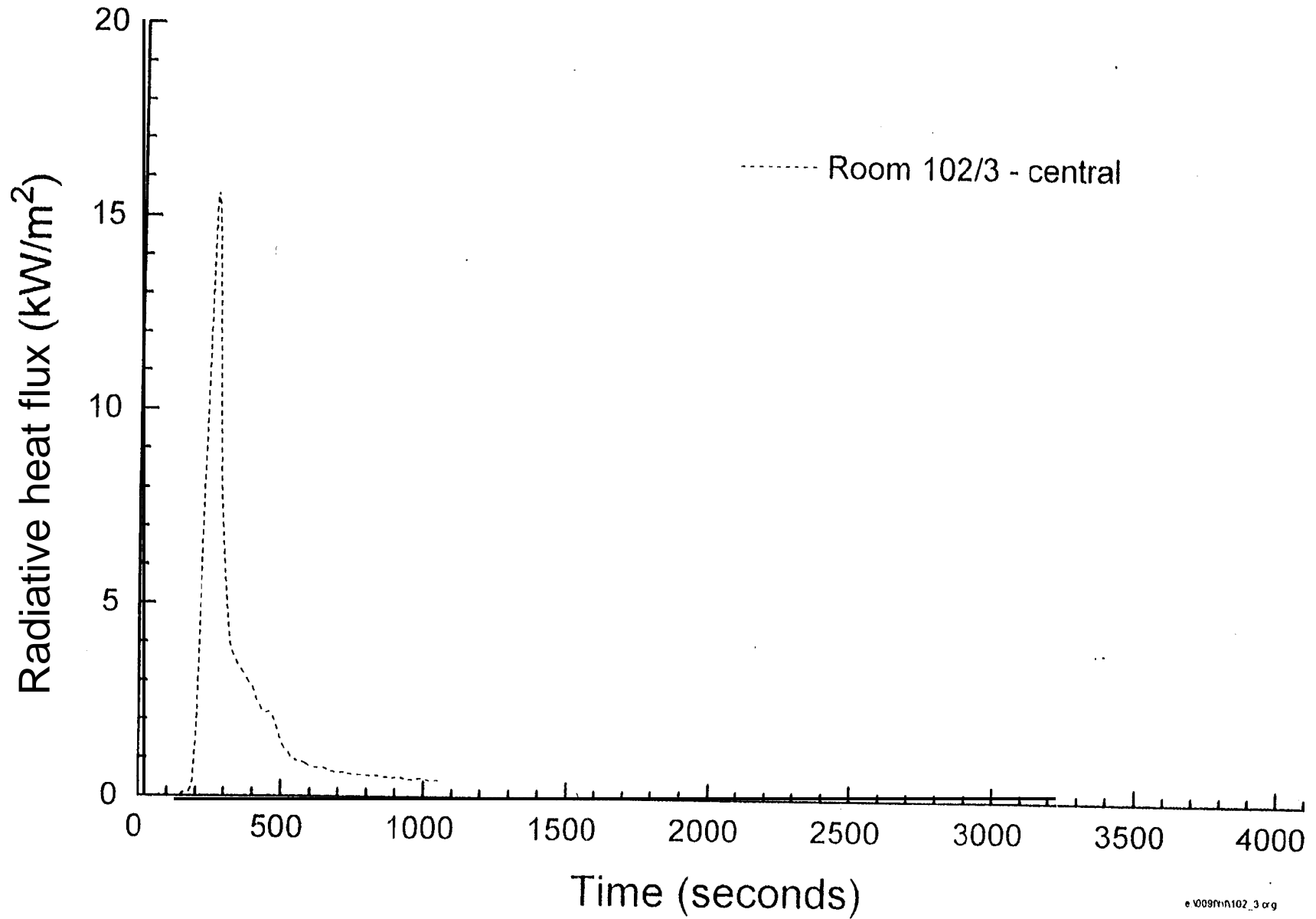

Fig. 8.2.5-5

Radiative heat flux (Flaming fire in large room) - Test FML5

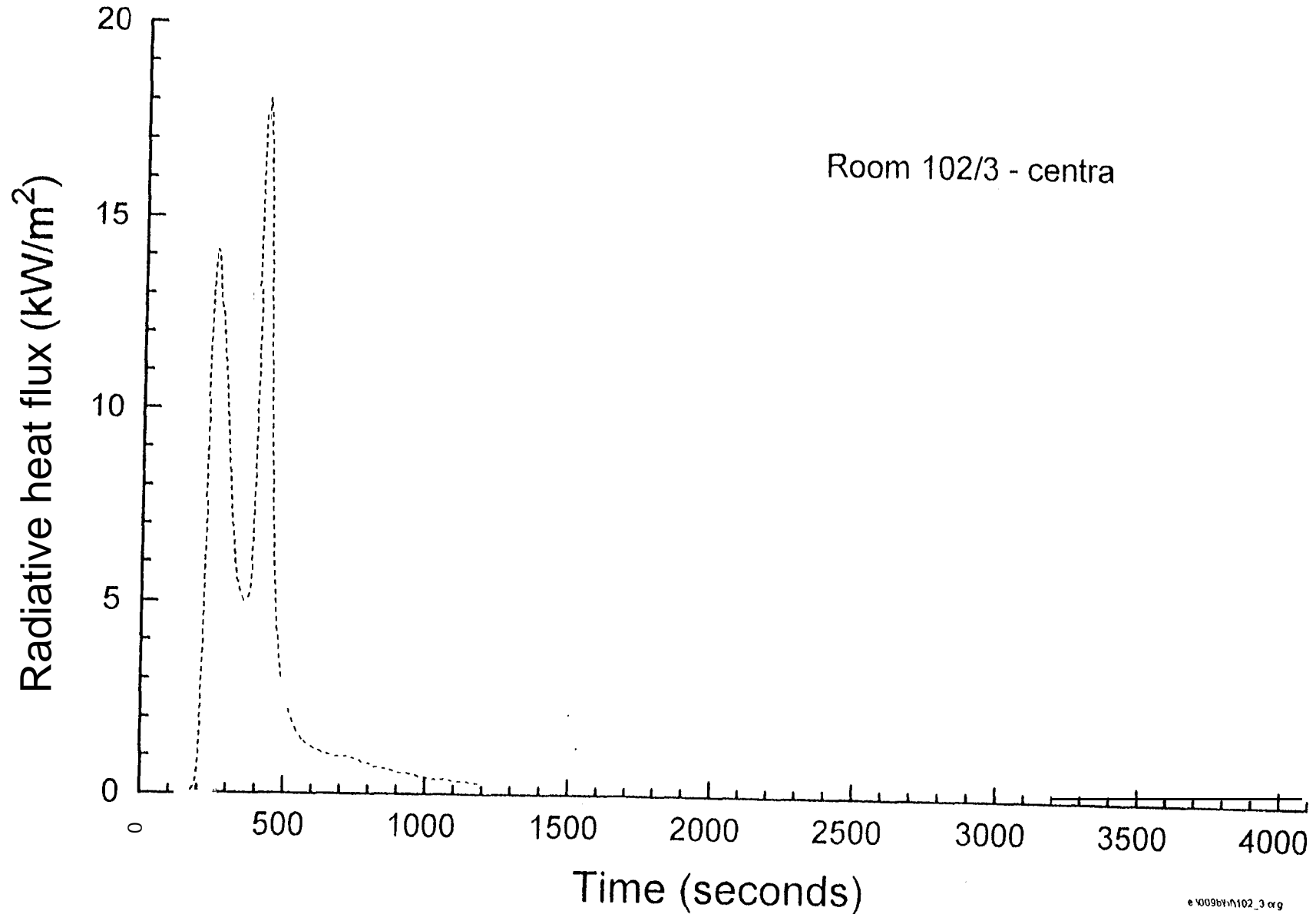

Fig. 8.2.5-6

Radiative heat flux (Flaming fire in large room) - Test FML6

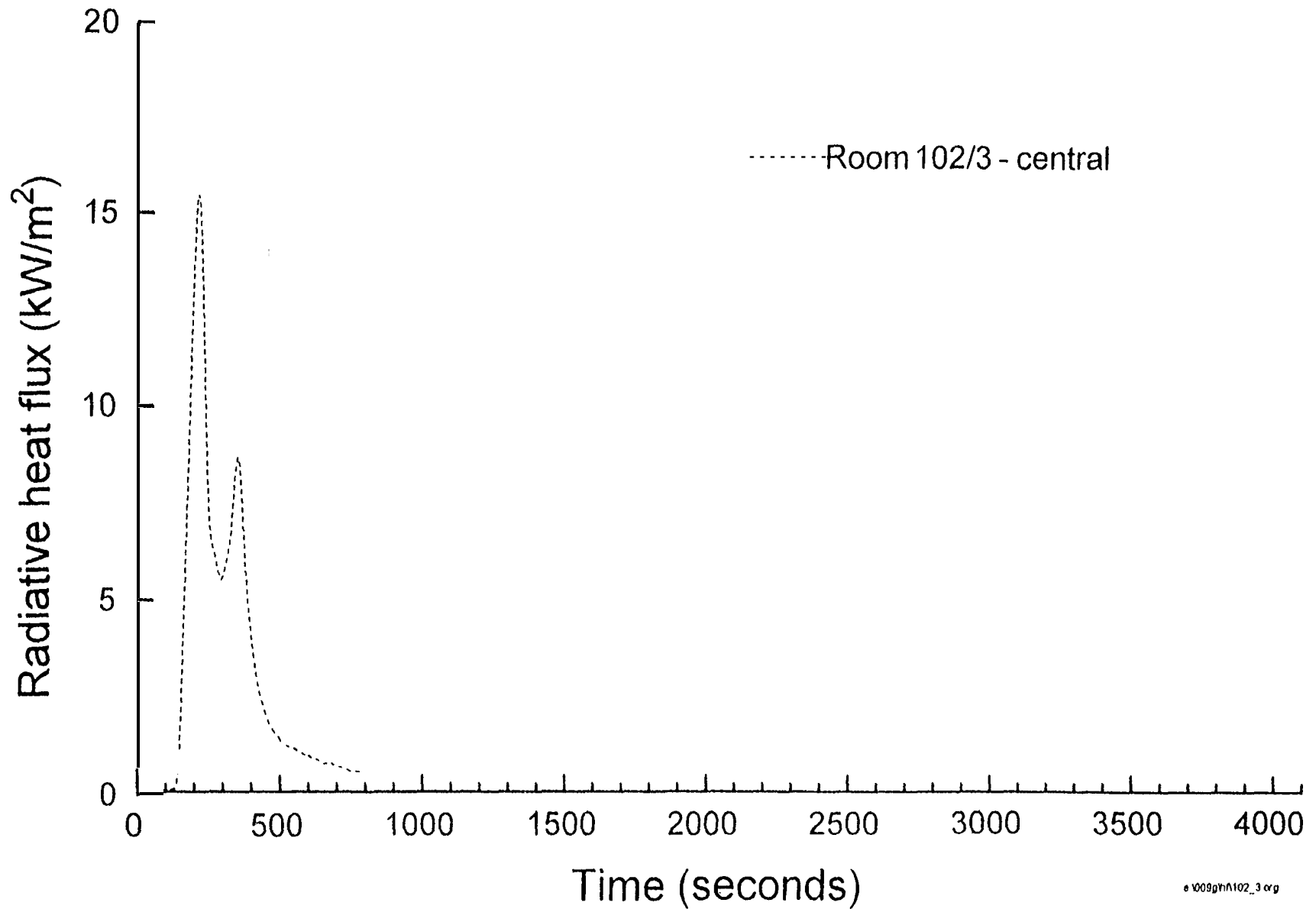

Fig. 8.2.5-7

Radiative heat flux (Flaming fire in large room) - Test FML7

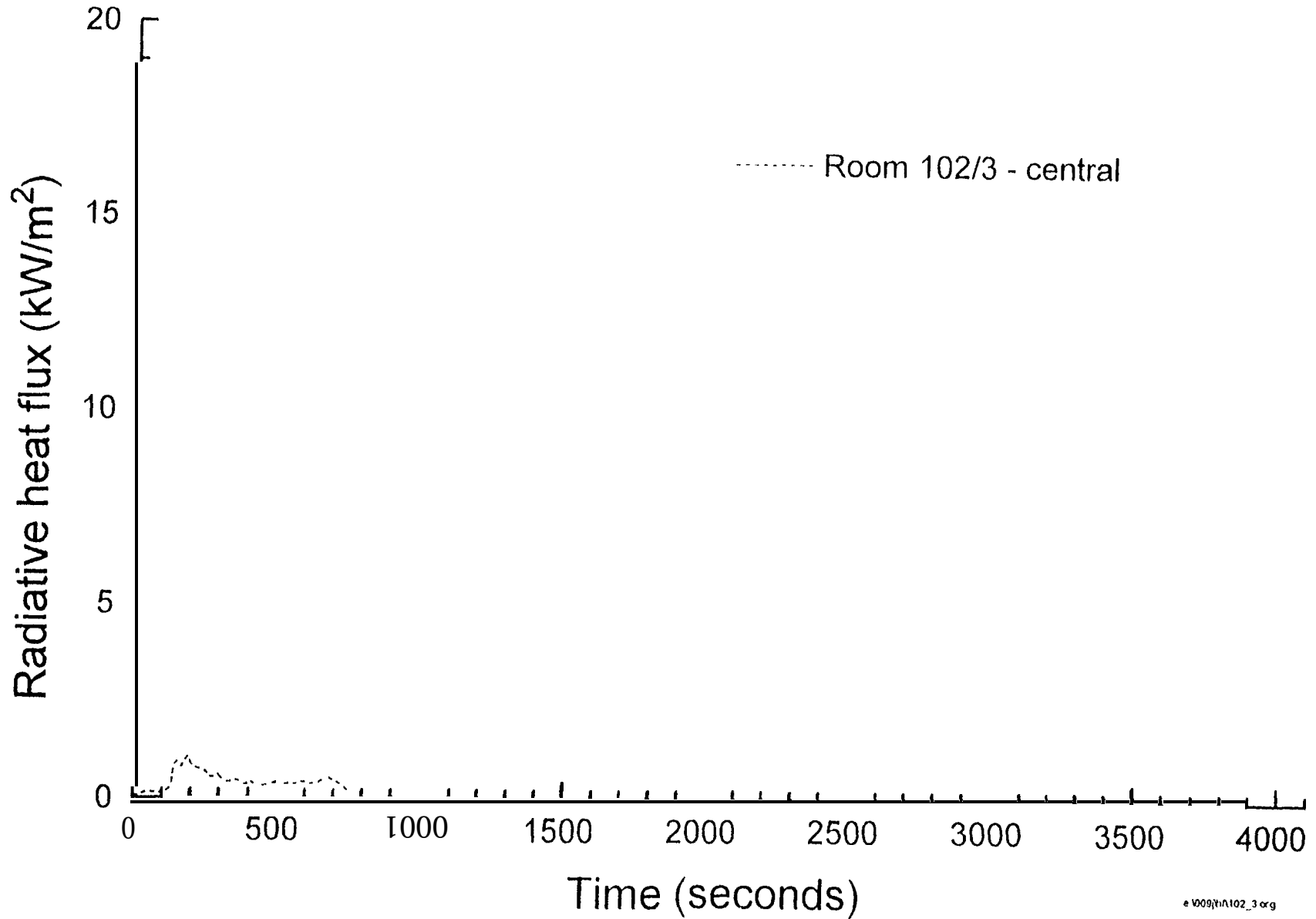

Fig. 8.2.6-1

Carbon monoxide concentration (Flaming fire in large room) - Test FML1

At 1900mm high in doorways

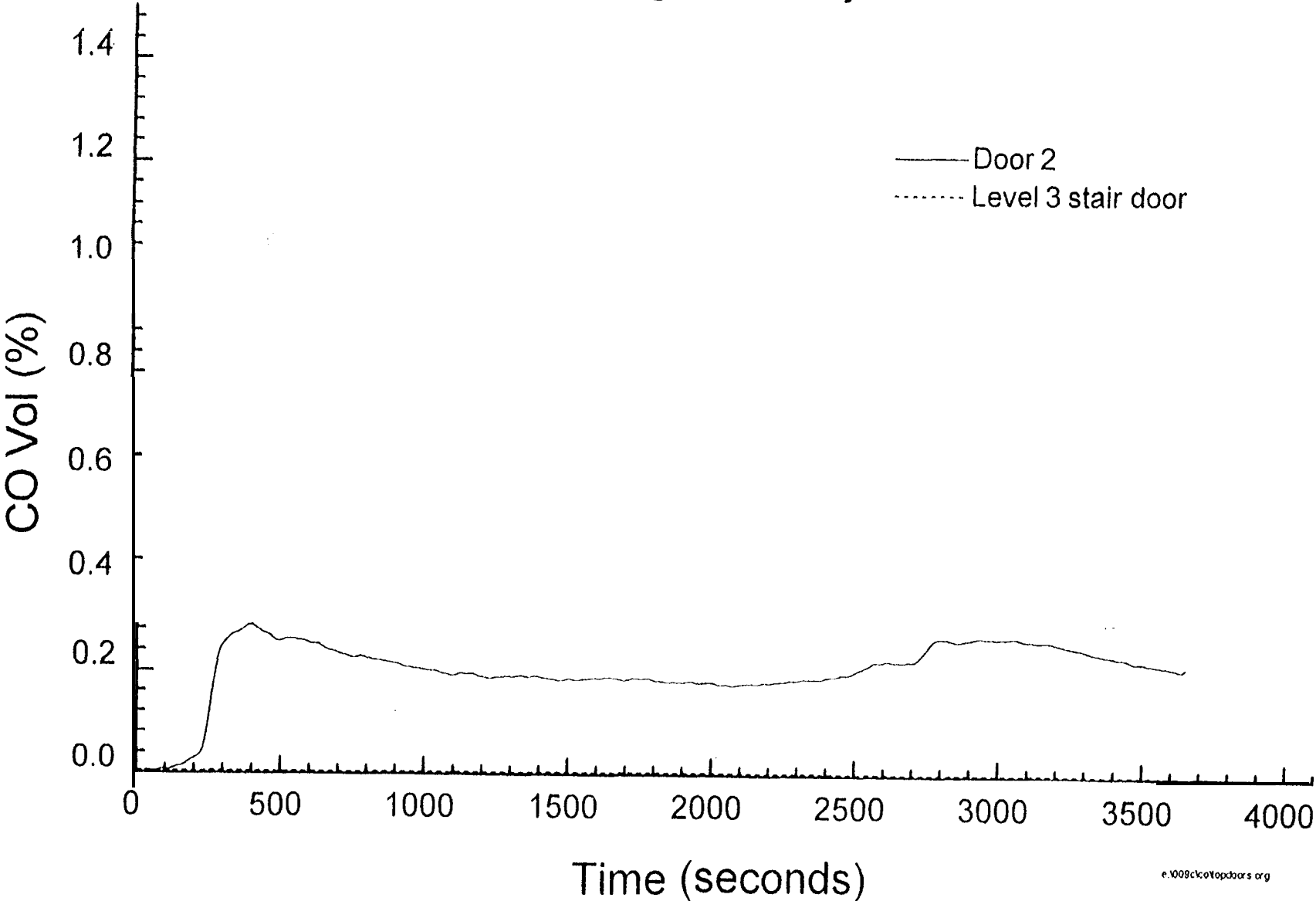

Fig. 8.2.6-2

Carbon monoxide concentration (Flaming fire in large room) - Test FML2

At 1900mm high in doorways

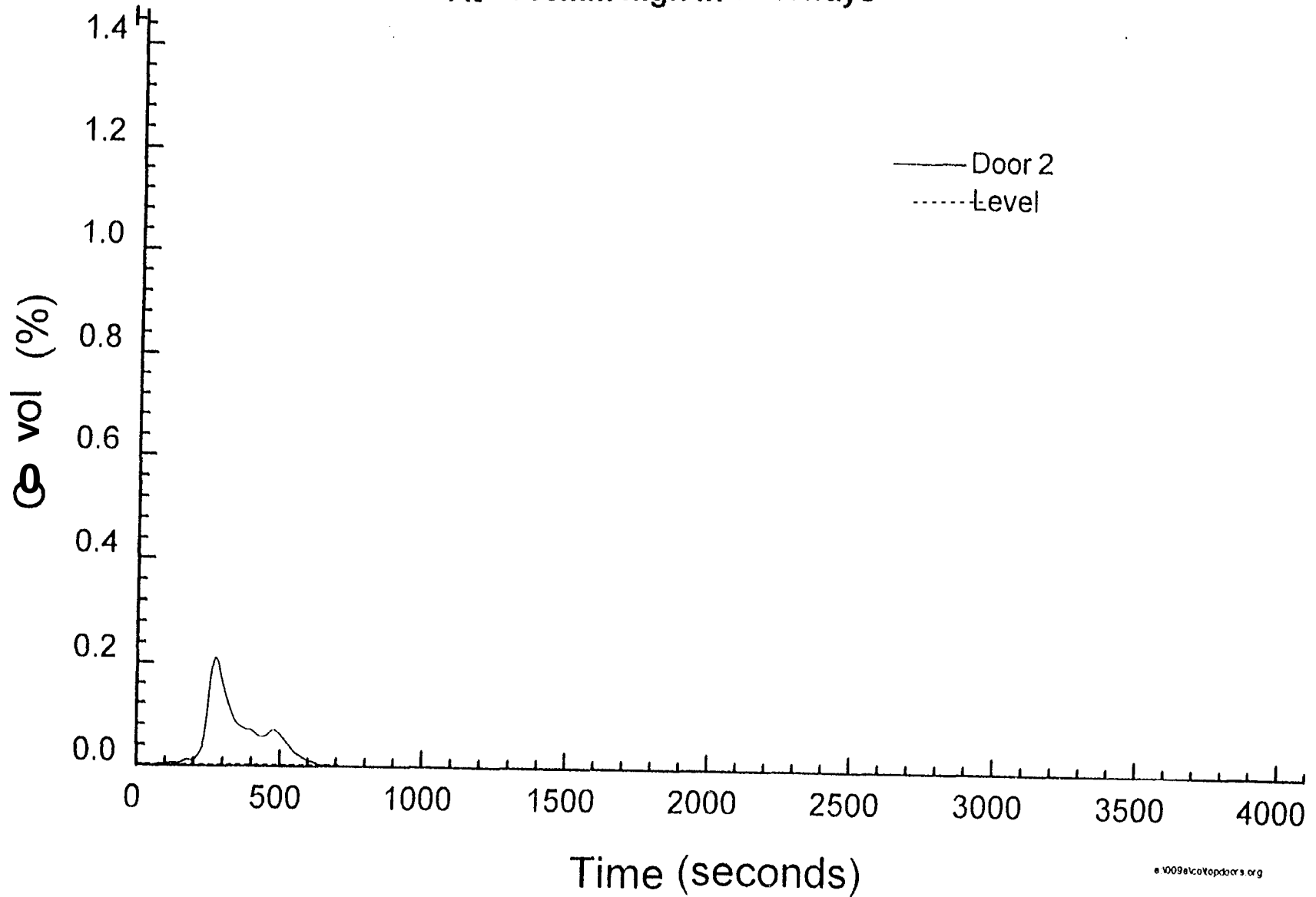

Fig. 8.2.6-3

Carbon monoxide concentration (Flaming fire in large room) - Test FML3

At 1900mm doorways

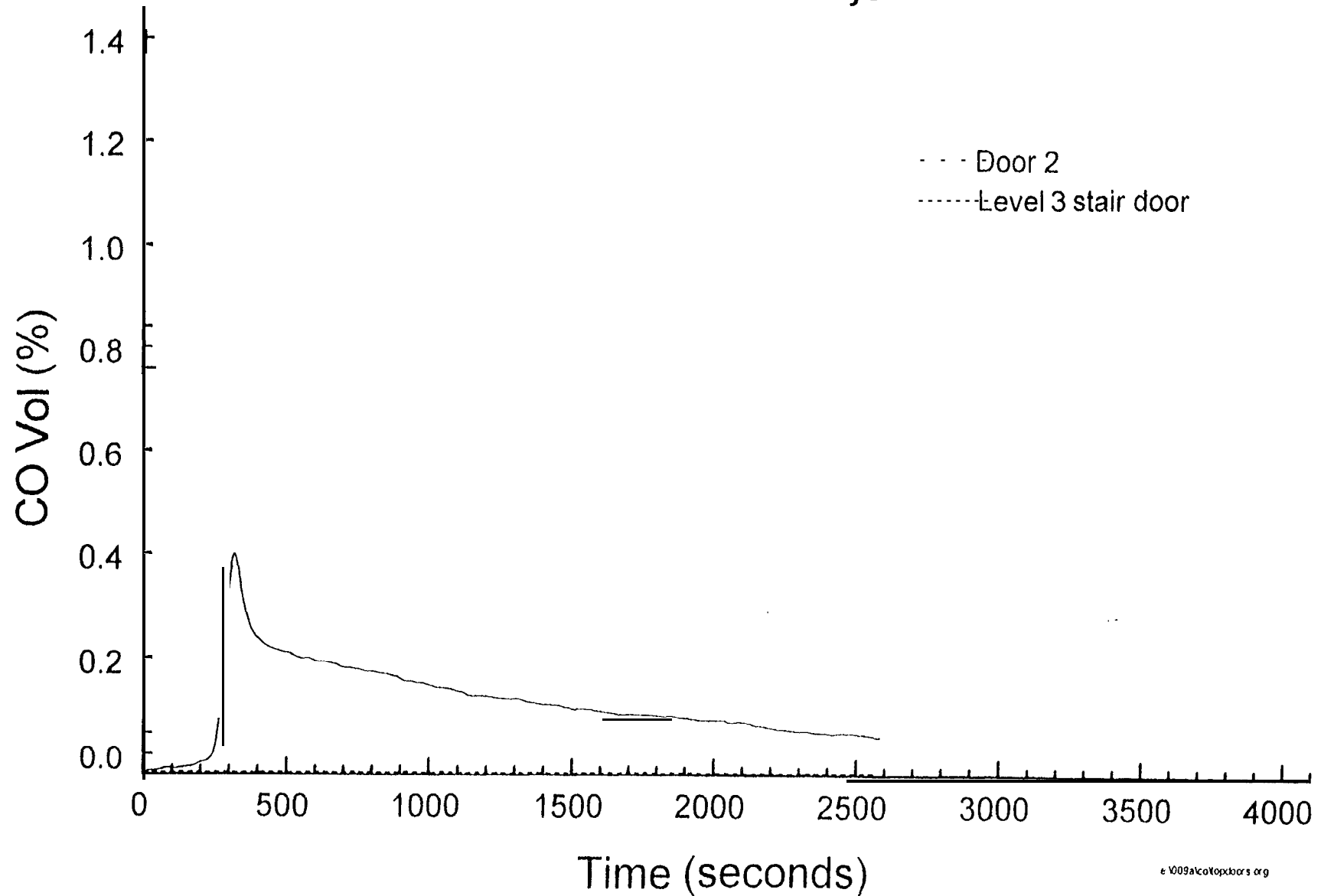

Fig. 8.2.6-4
concentration (Flaming fire in large room) - Test FML4
At 1900mm high in doorways

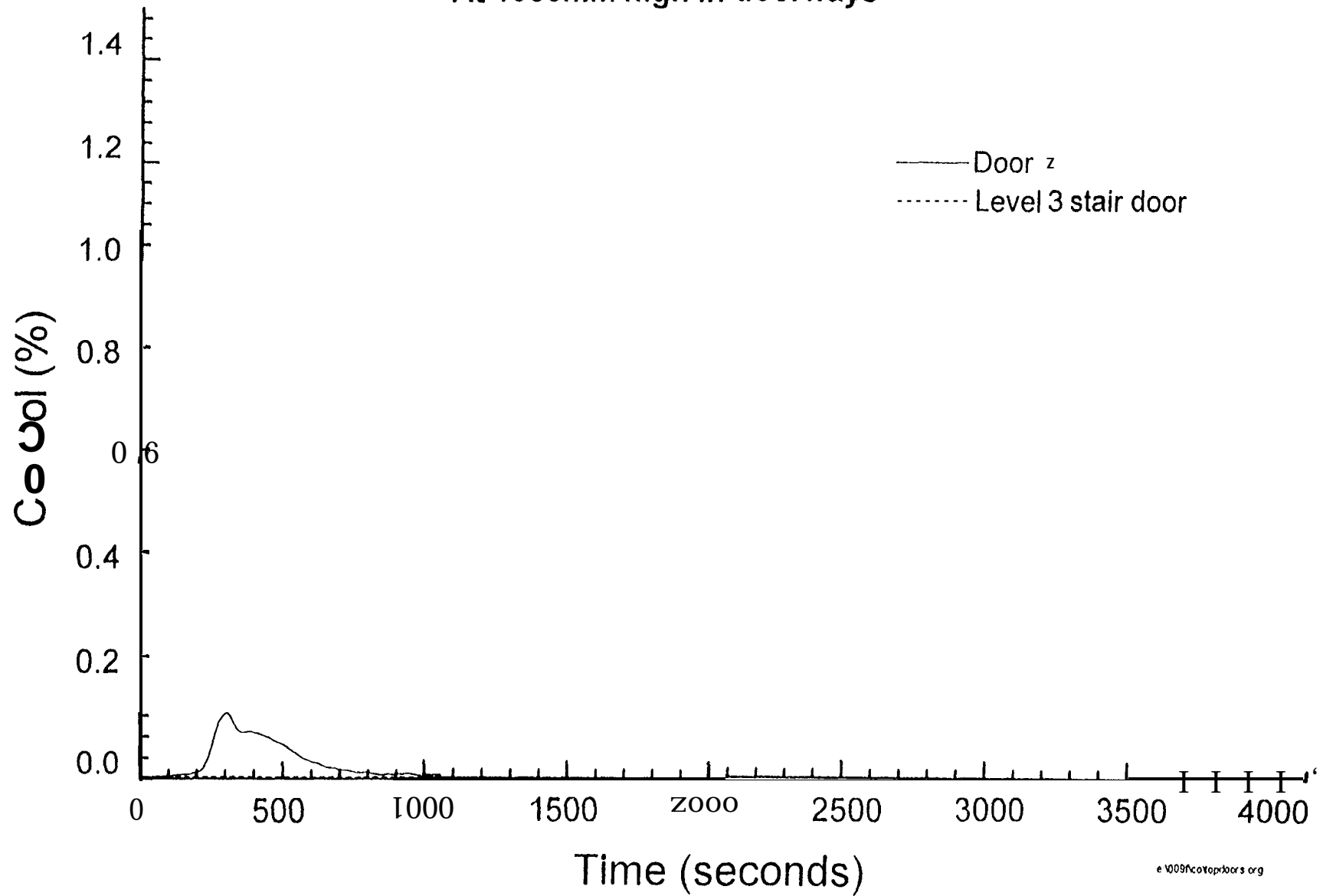

Fig. 8.2.6-5

Carbon monoxide concentration (Flaming fire in large room) - Test ML5

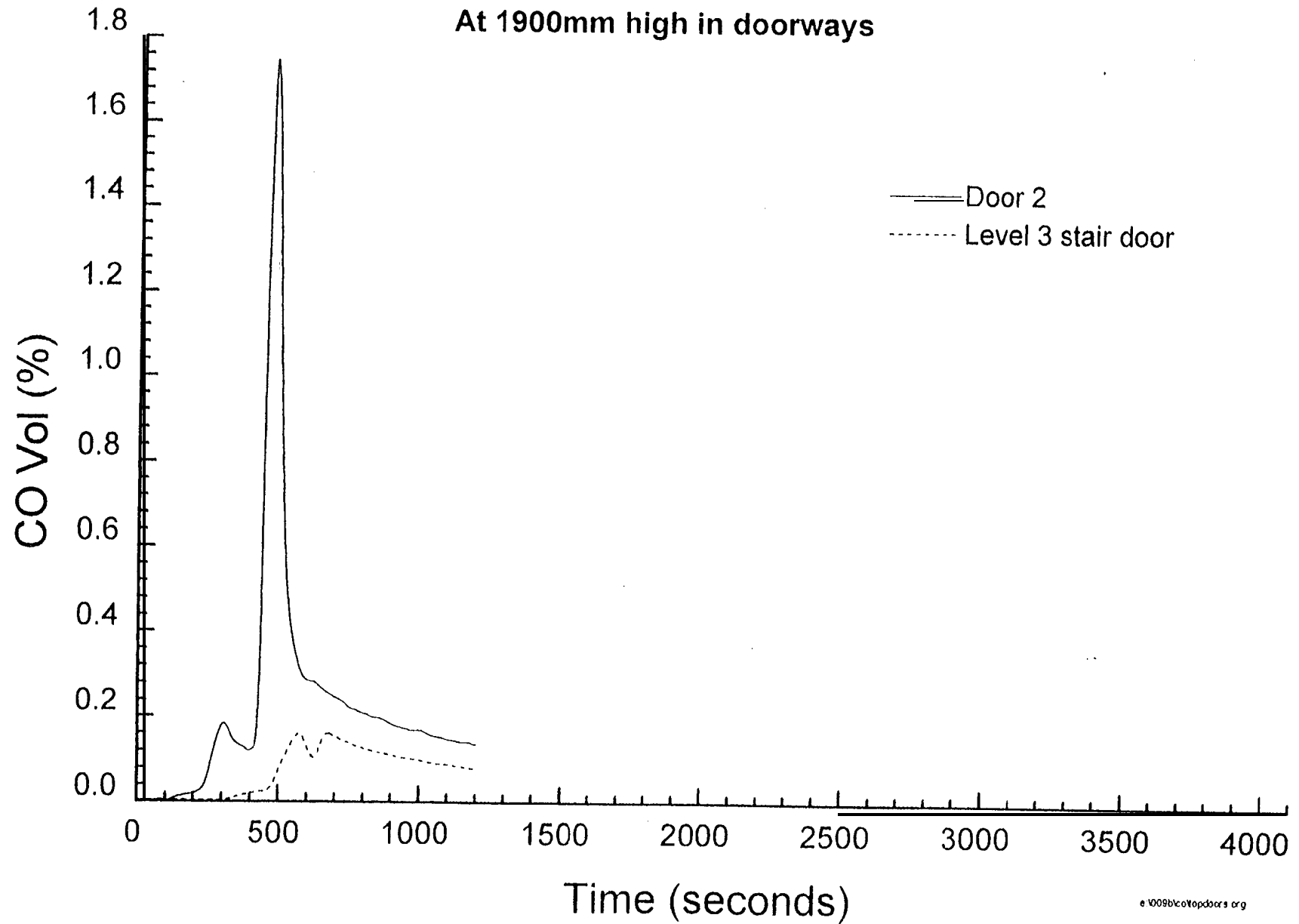

Fig. 8.2.6-6

Carbon monoxide concentration (flaming fire in large room) - Test FML6

At 1900mm high in doorways

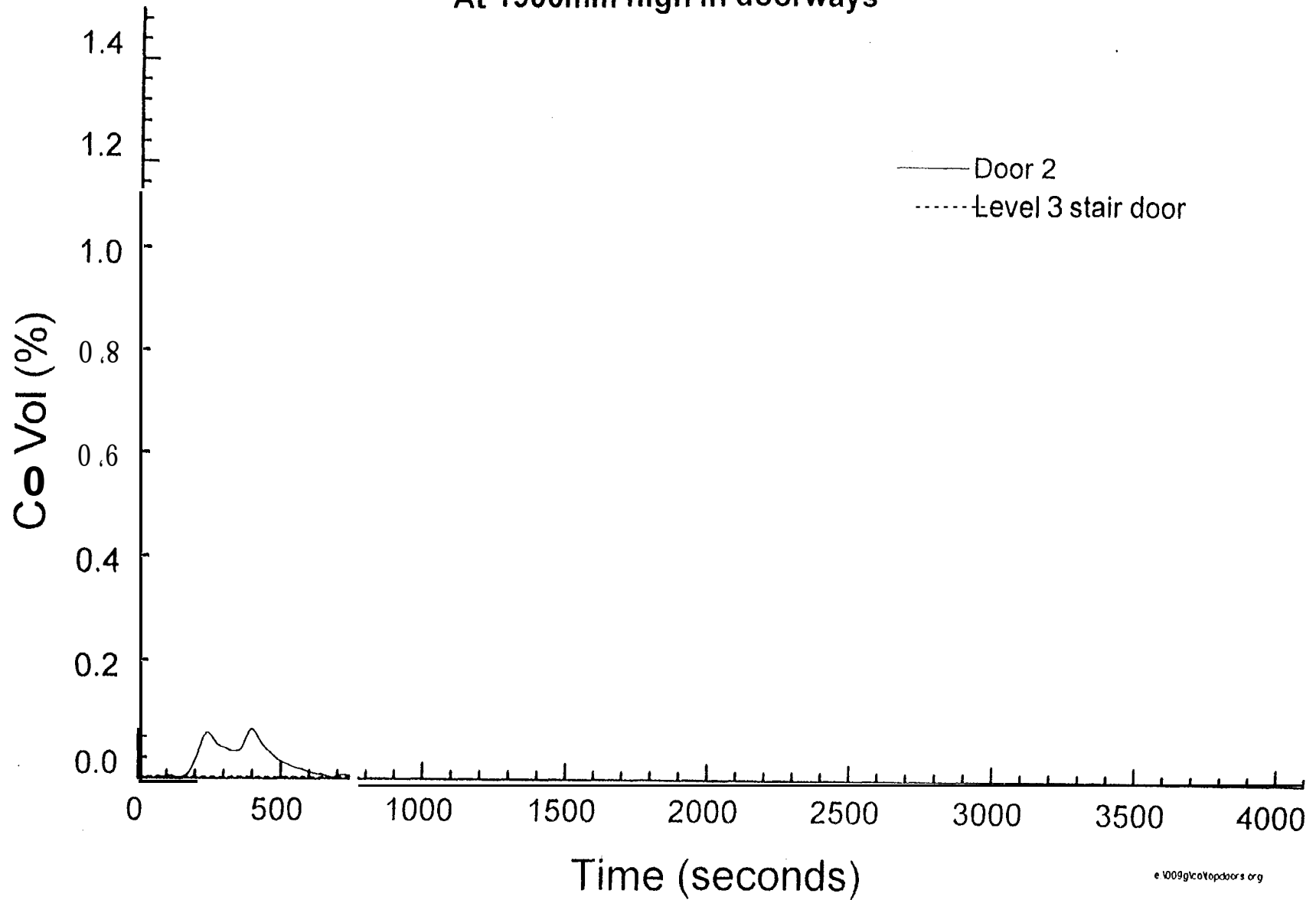

Fig. 8.2.6-7

Carbon monoxide concentration (flaming fire in large room) - Test [ML7

At 1900mm high in doorways

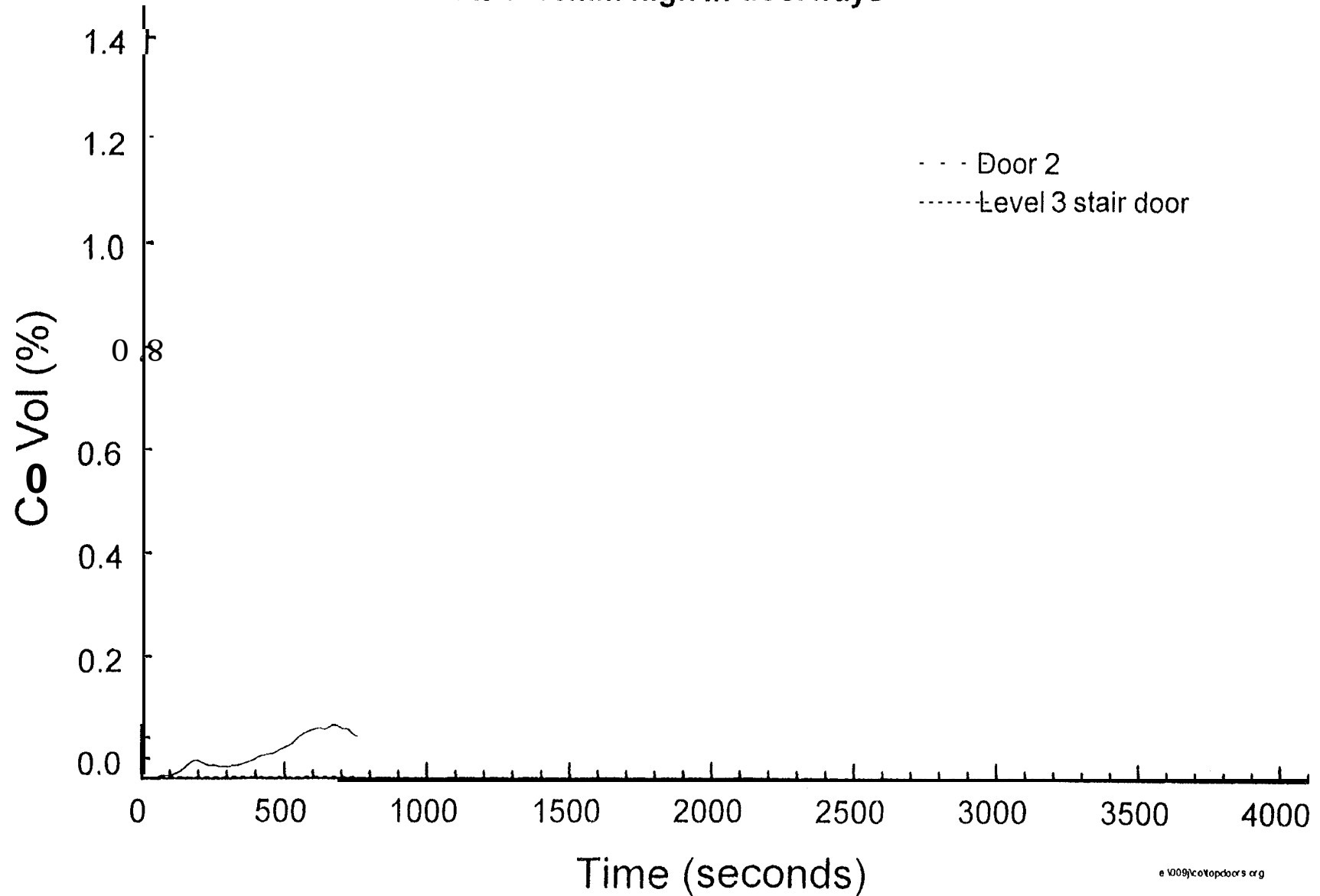

Fig. 8.2.7-1
Oxygen concentration (Flaming fire in large room) - Test FML1

Average of 3 points in room 102

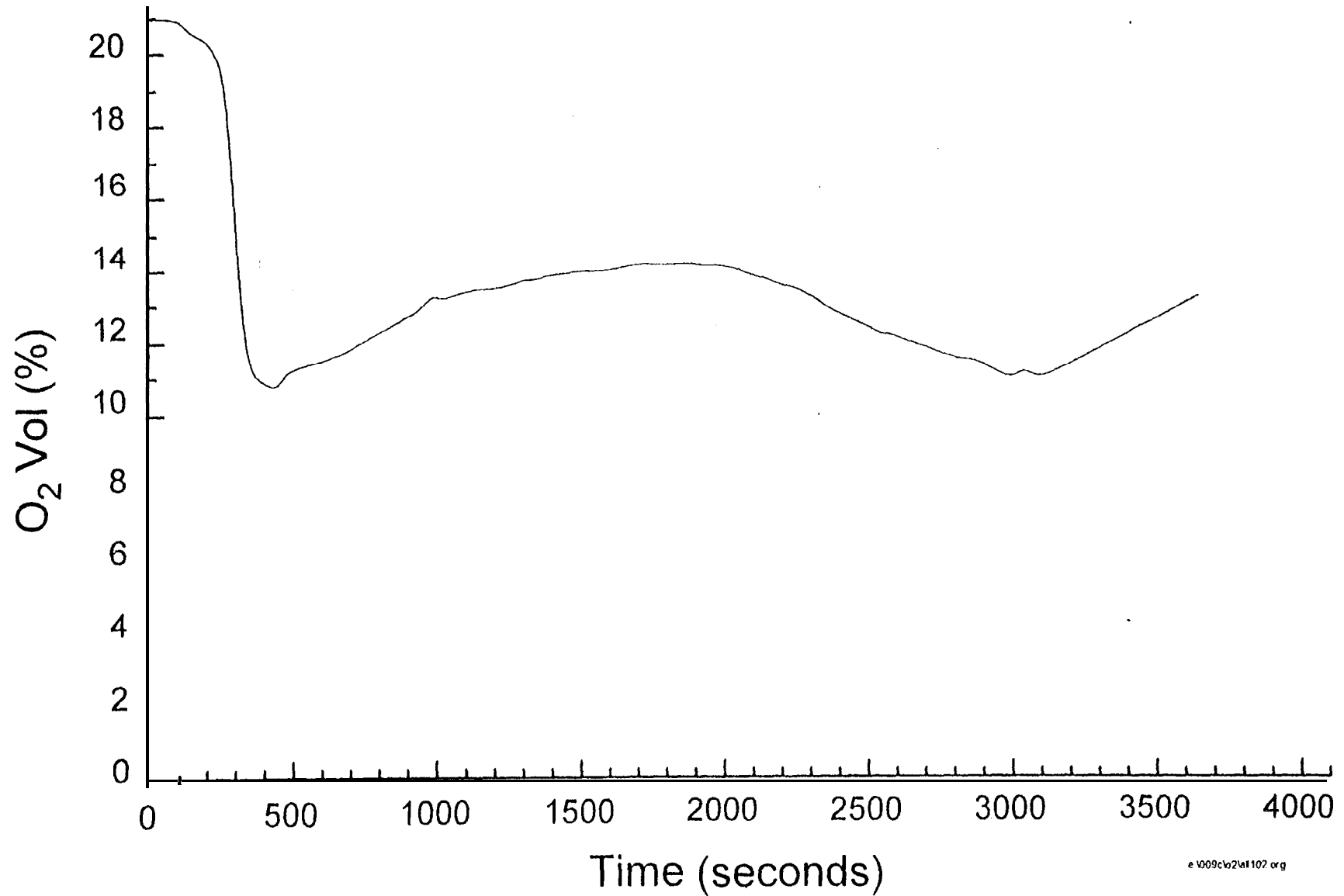

Fig. 8.2.7-2

Oxygen concentration (Flaming fire in large room) - Test FML2

Average of 3 points in room 102

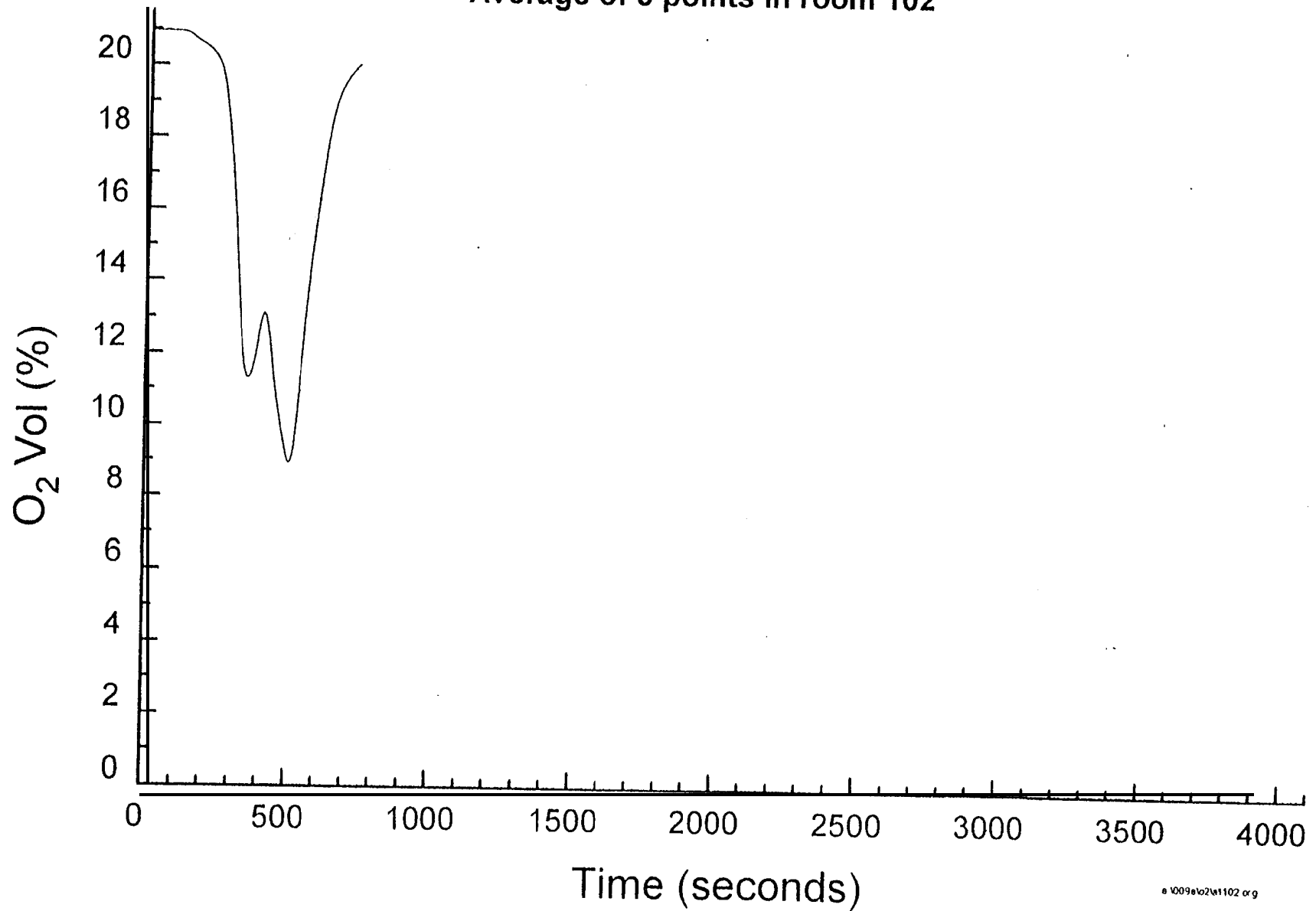

Fig. 8.2.7-3

Oxygen concentration (Flaming fire in large room) - Test FML3

Average of 3 points in room 102

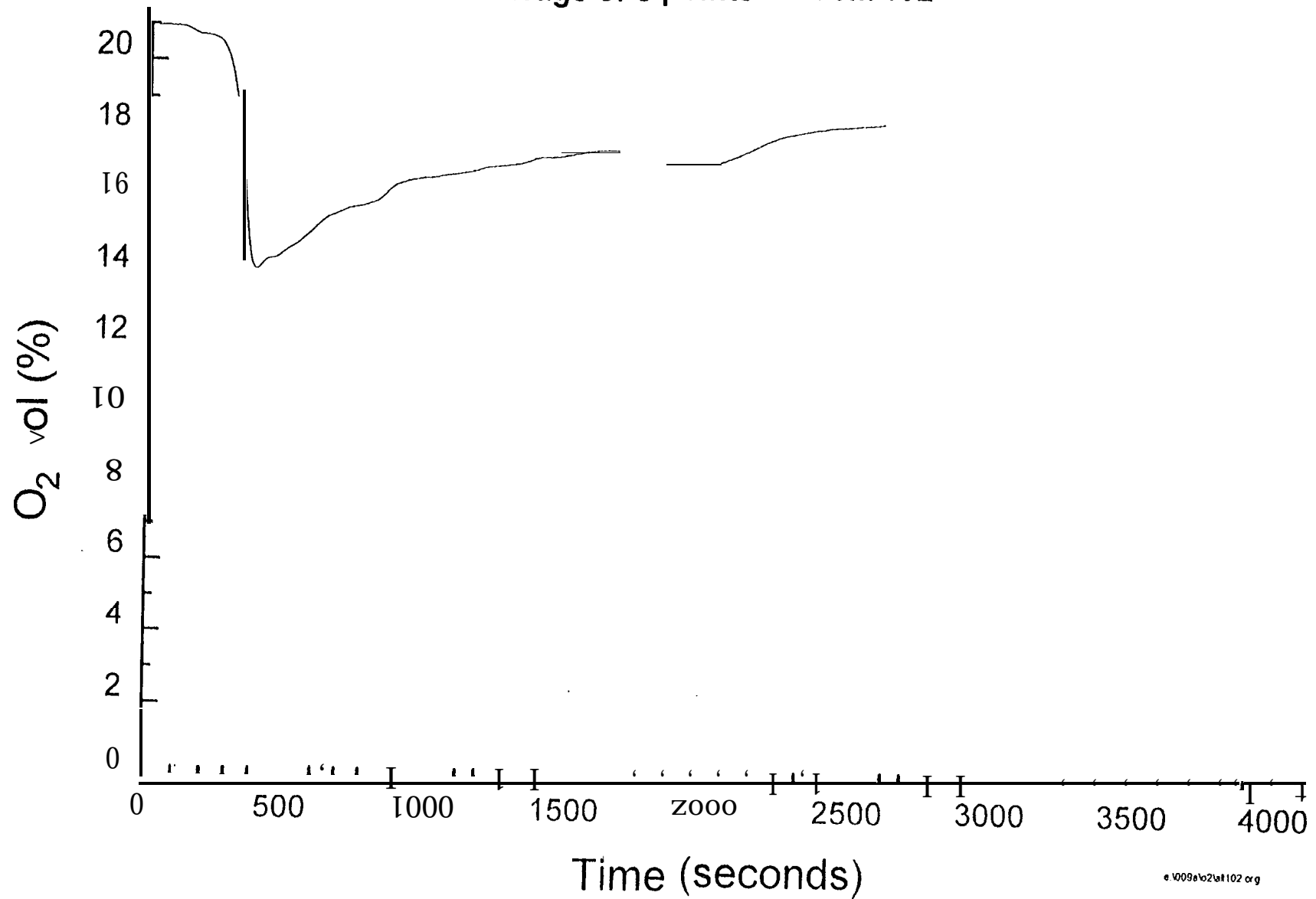

Fig. 8.2.7-4

Oxygen concentration (Flaming fire in large room) - Test FML4

Average of 3 points in room 102

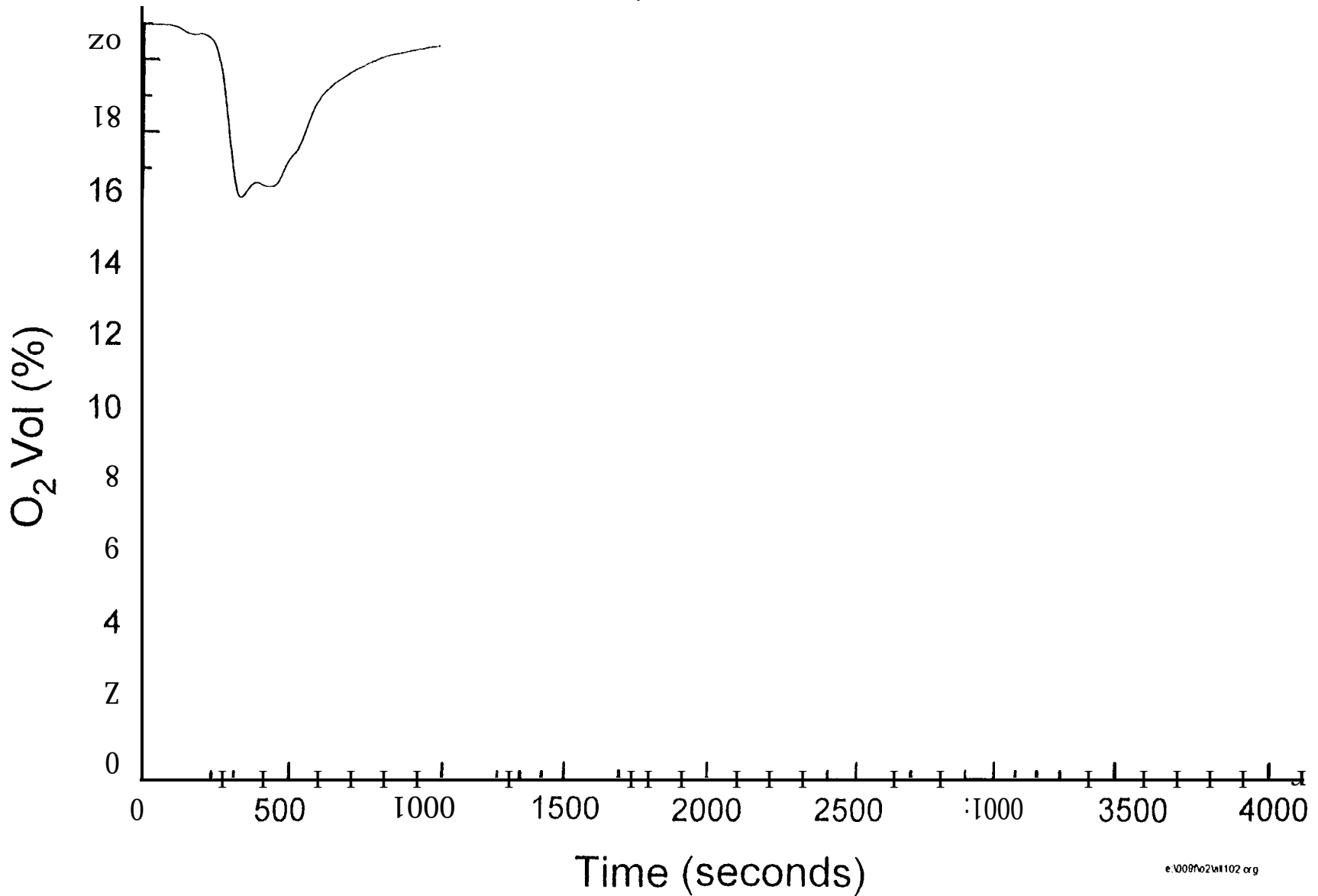

Fig. 8.2.7-5

Oxygen concentration (Flaming fire in large room) - Test FML5

Average of 3 points in room 102

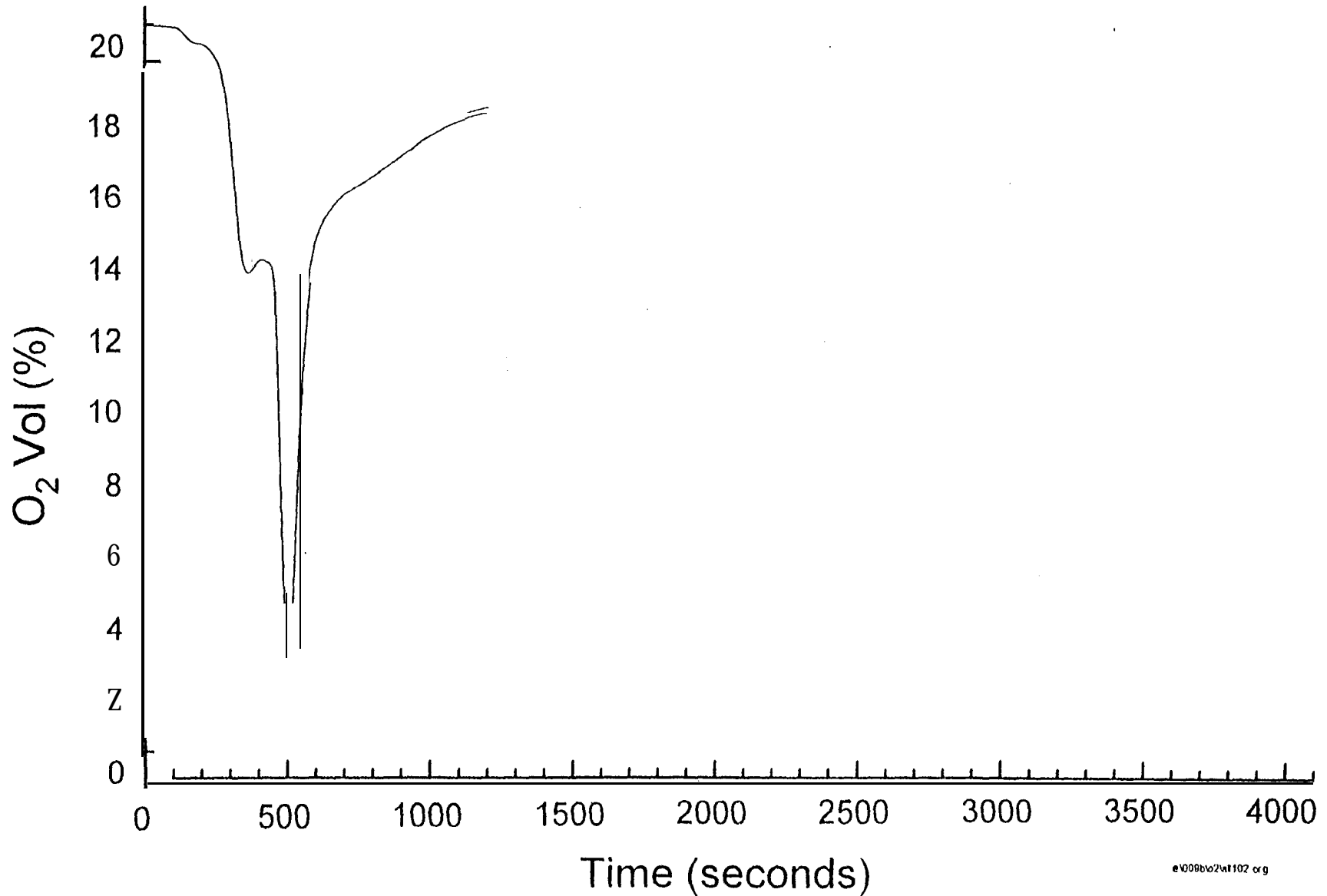

Fig. 8.2.7-6

large room) - Test FML6

Average points in room 102

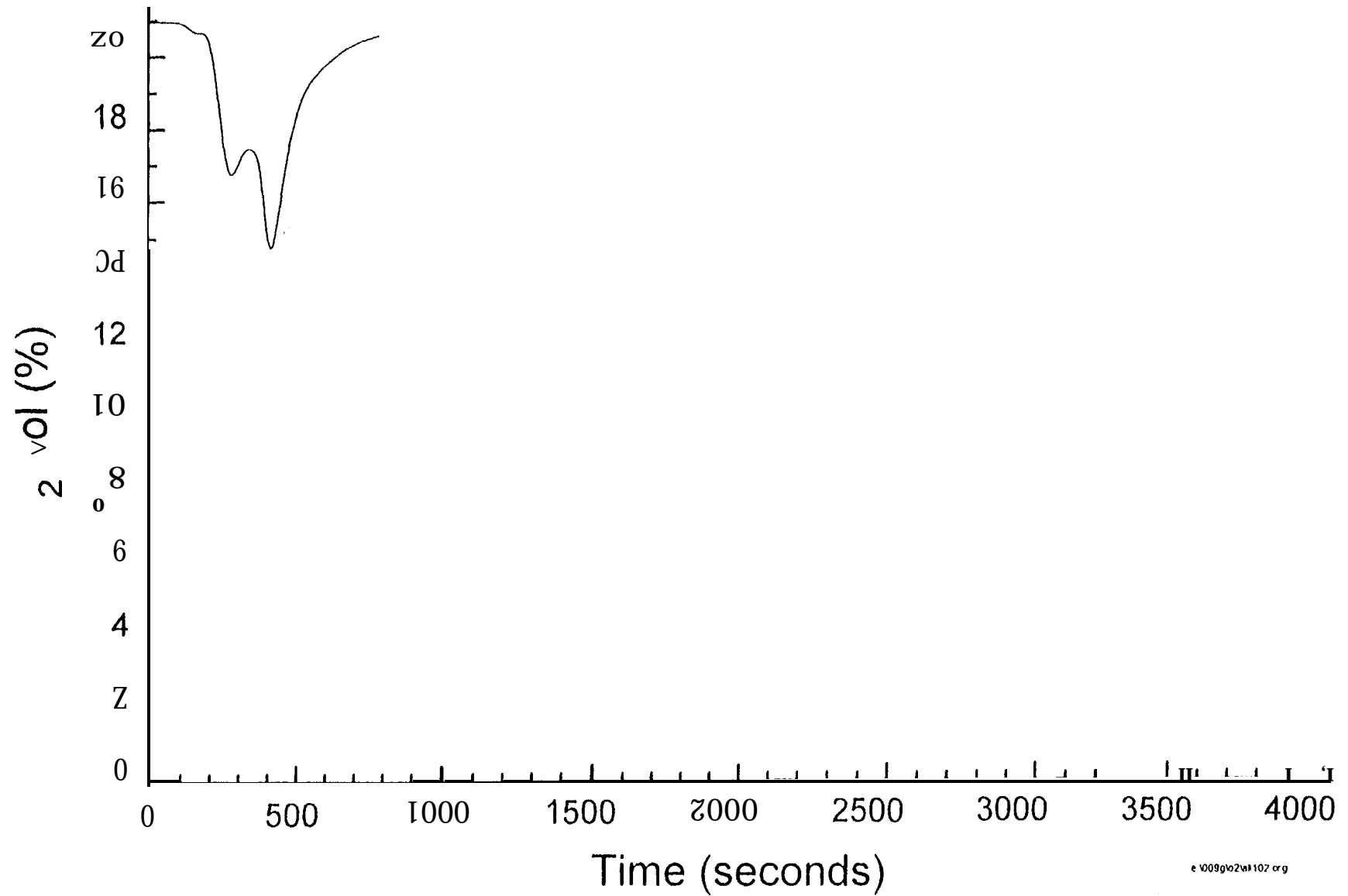

Fig. 8.2.7-7

Oxygen concentration (Flaming fire in large room) - Test FML7

Average of 3 points in room 102

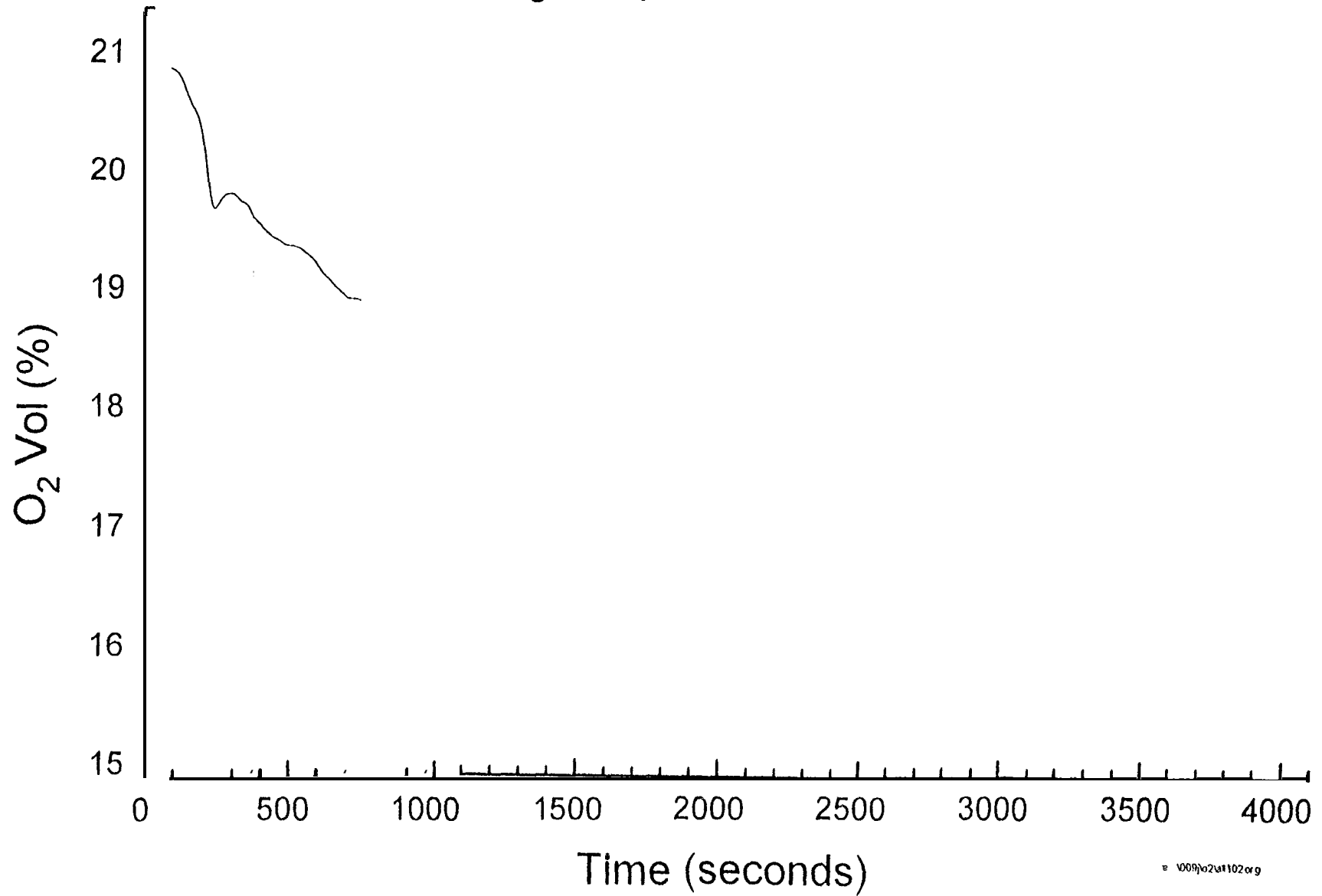

Fig. 8.2.7-8

Carbon

Oxygen concentrations - Test FML1

(Flaming

At various heights in door 2

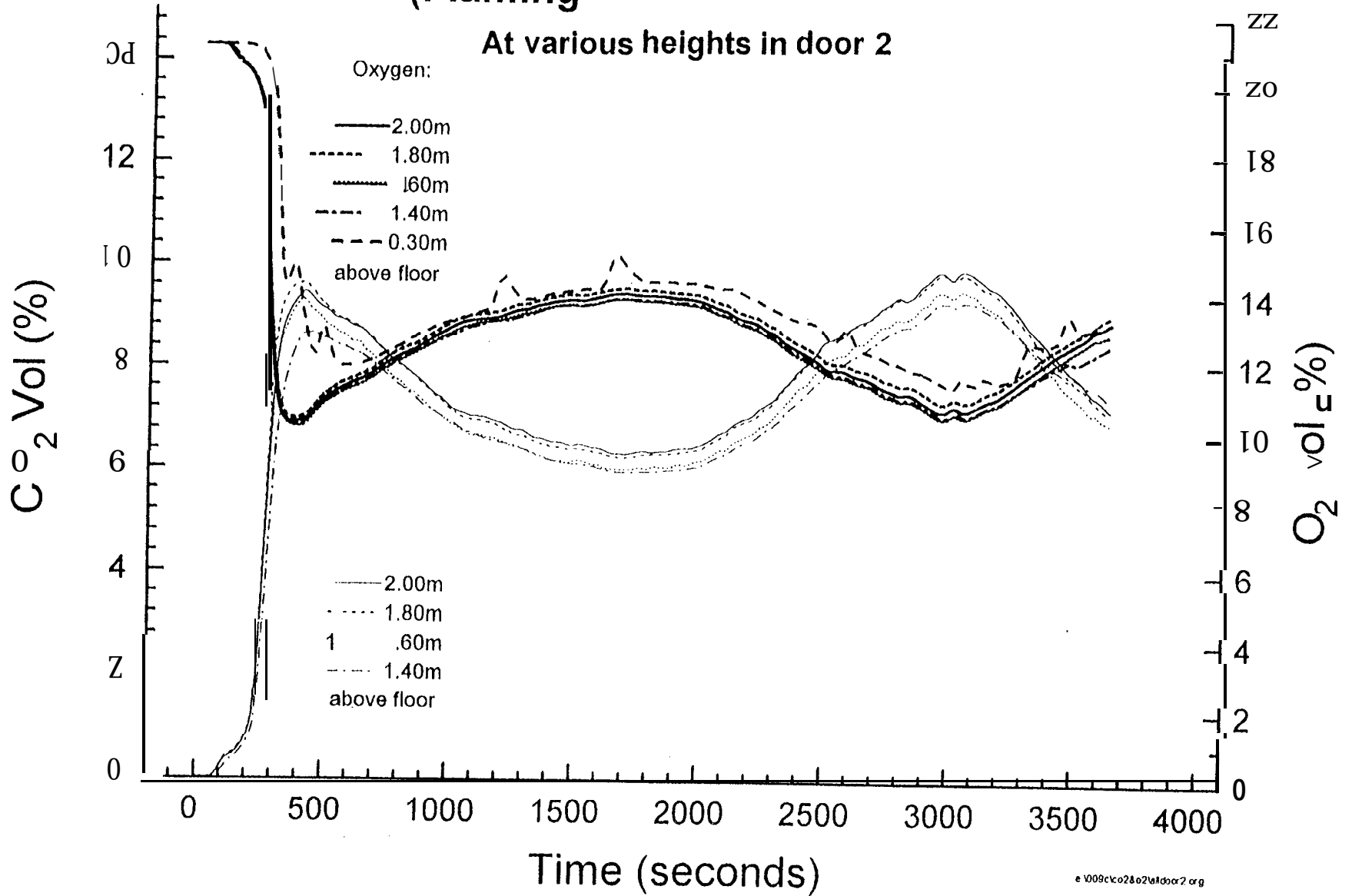

Fig. 8.2.7-9

Carbon Dioxide and Oxygen concentrations - Test cML2
(Flaming fire in large room)

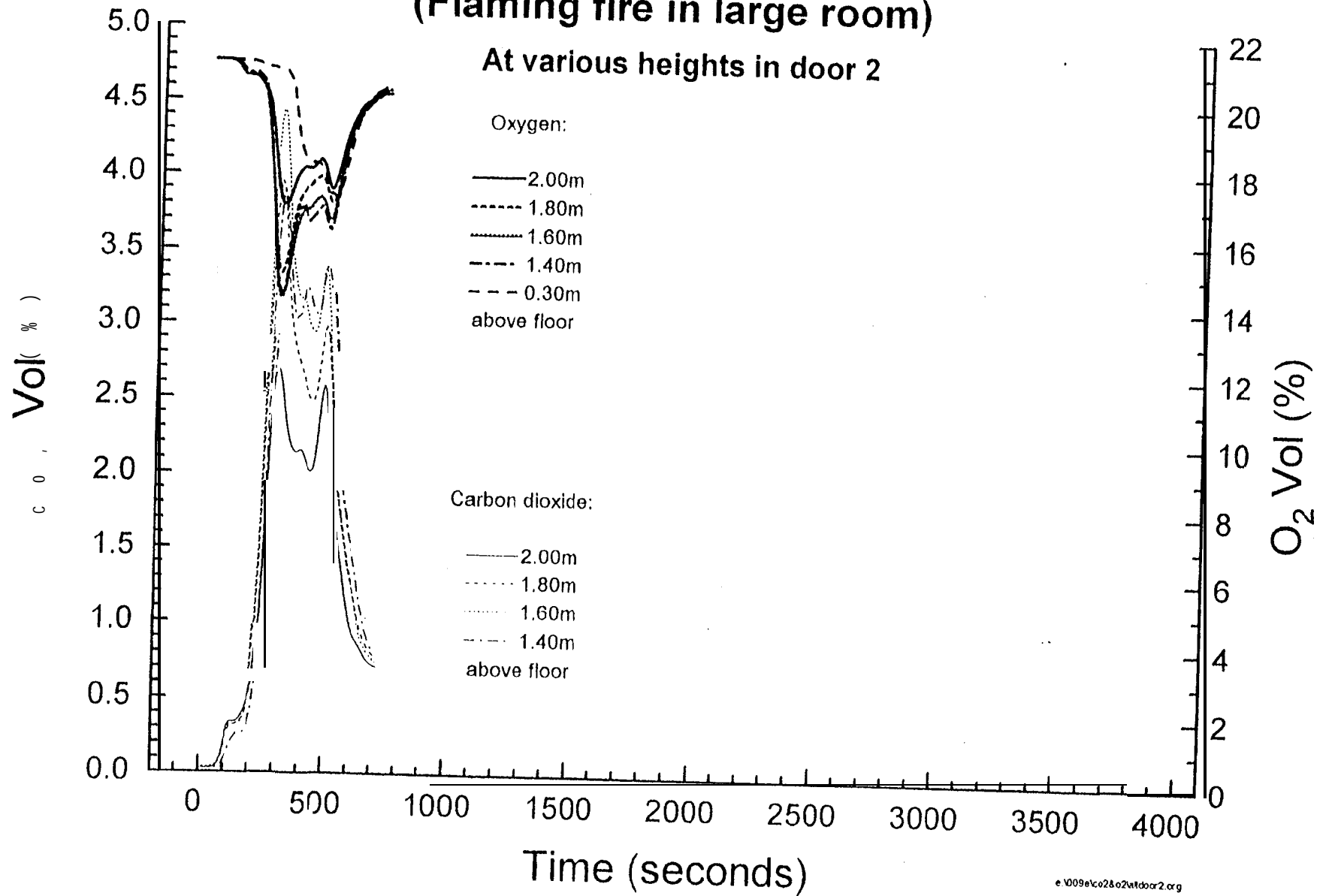

Fig. 8.2.7-10
Carbon dioxide and Oxygen concentrations - Test FML3
(Flaming fire in large room)

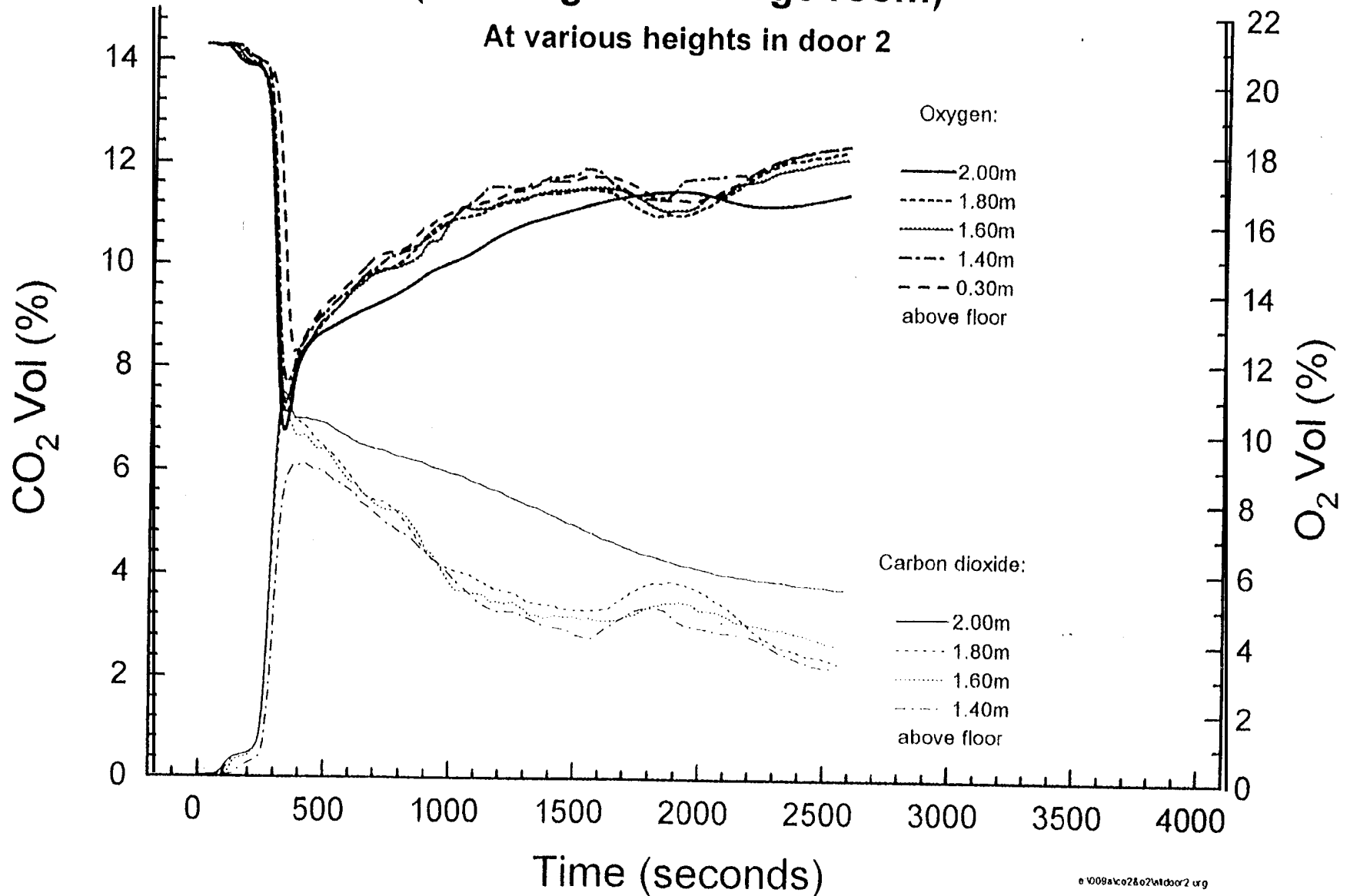

Fig. 8.2.7-11

Carbon dioxide and Oxygen concentrations - Test ML4
(Flaming fire in large room)

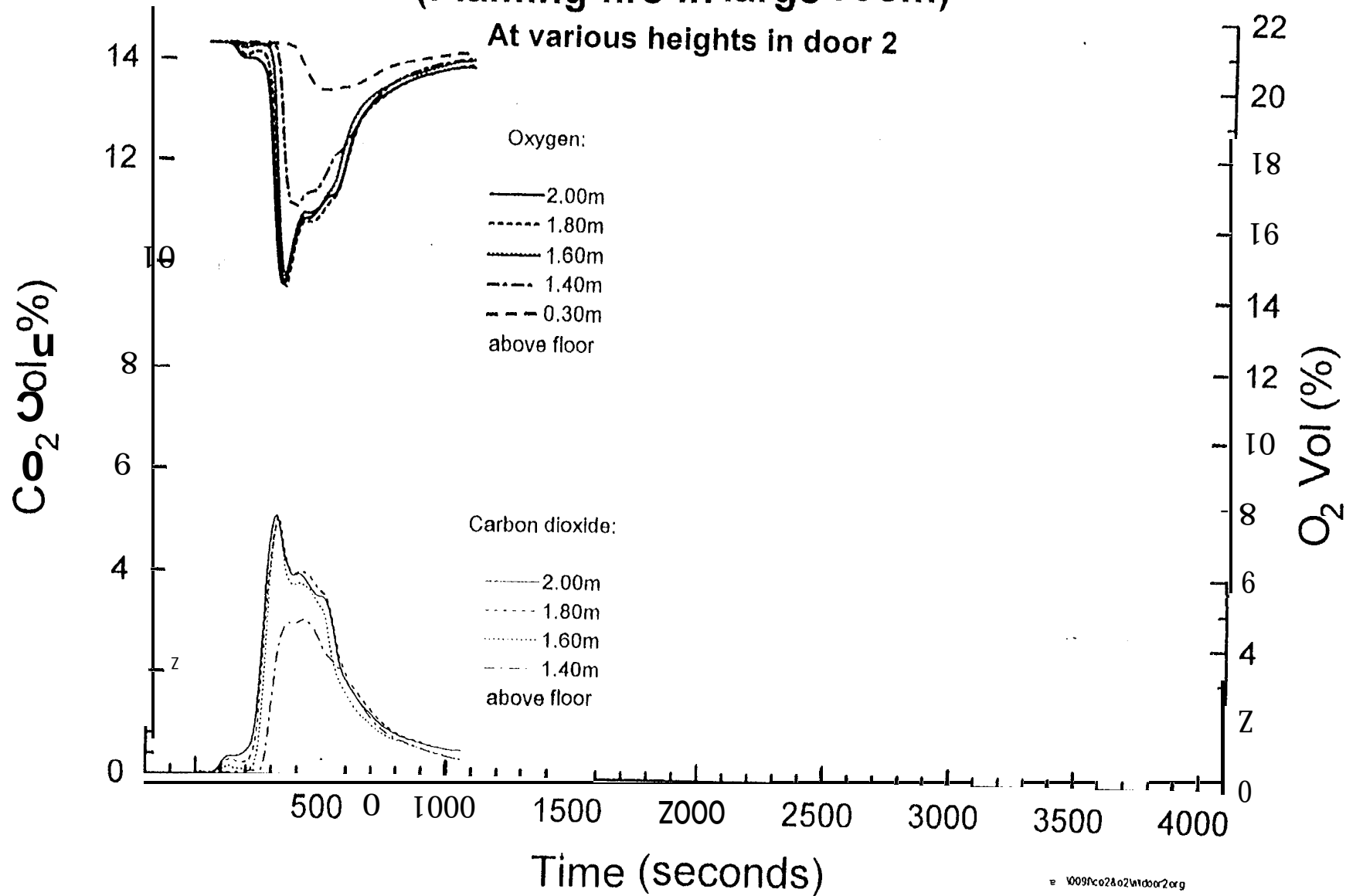

Fig. 8.2.7-1 2
and Oxygen concentrations - Test ML5
(Flaming fire in larger room)

At various heights in door 2

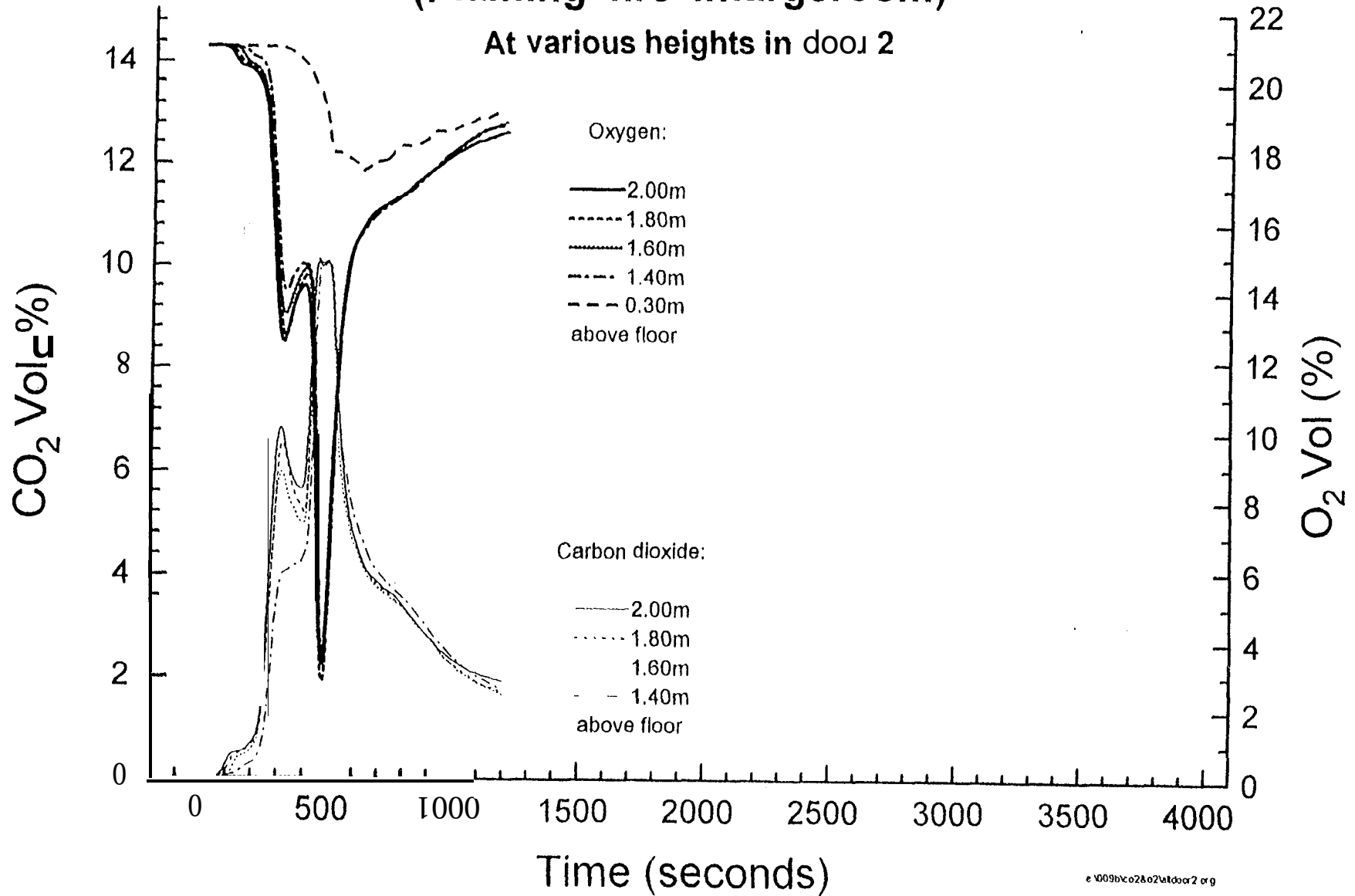

Fig. 8.2.7-1 3

Oxygen concentrations - Test FML6
(Flaming fire in large room)

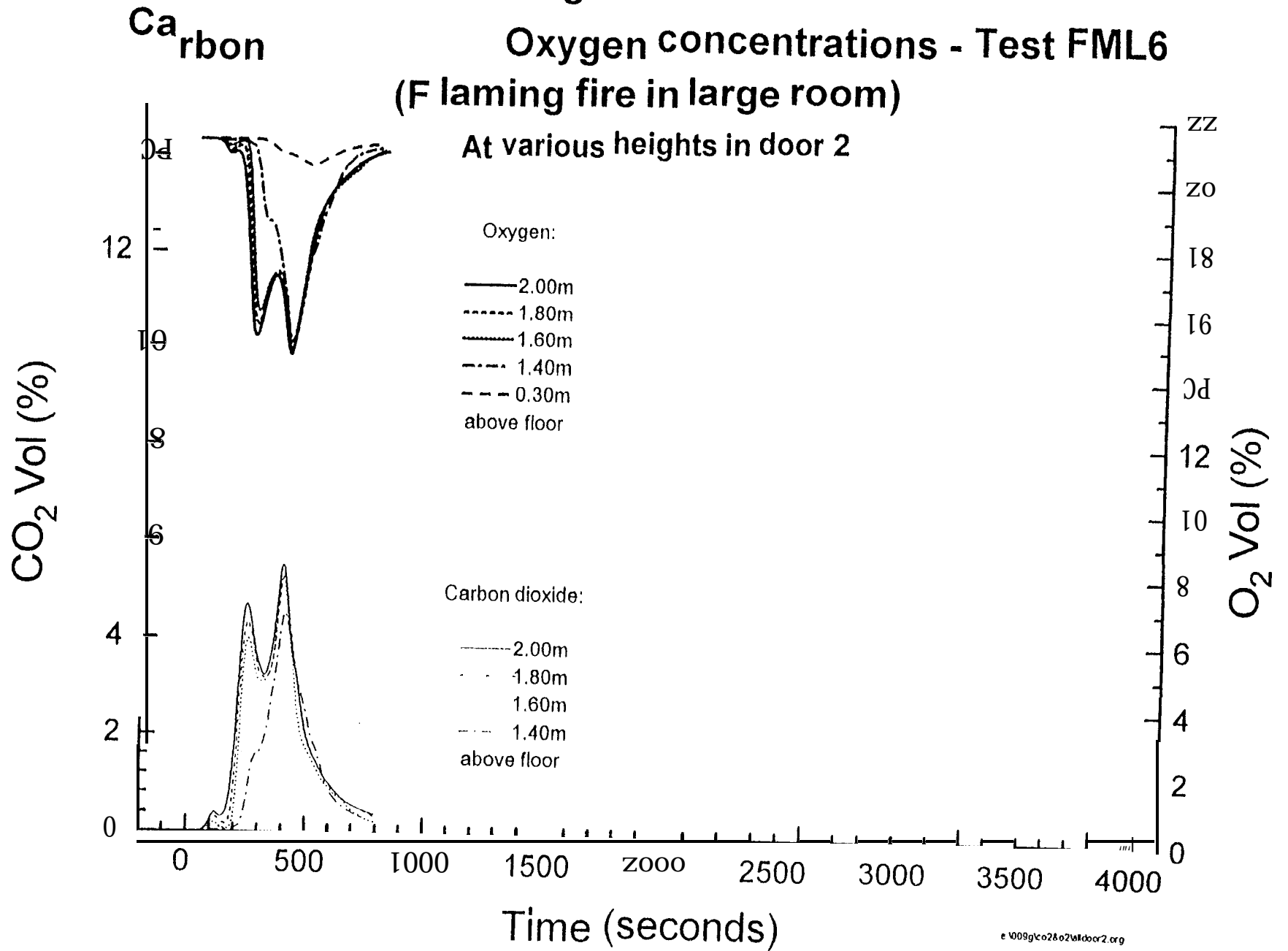

Fig. 8.2.7-1 4

Carbon

Oxygen concentrations - Test FML7

(Flaming fire in large room)

At various heights in door 2

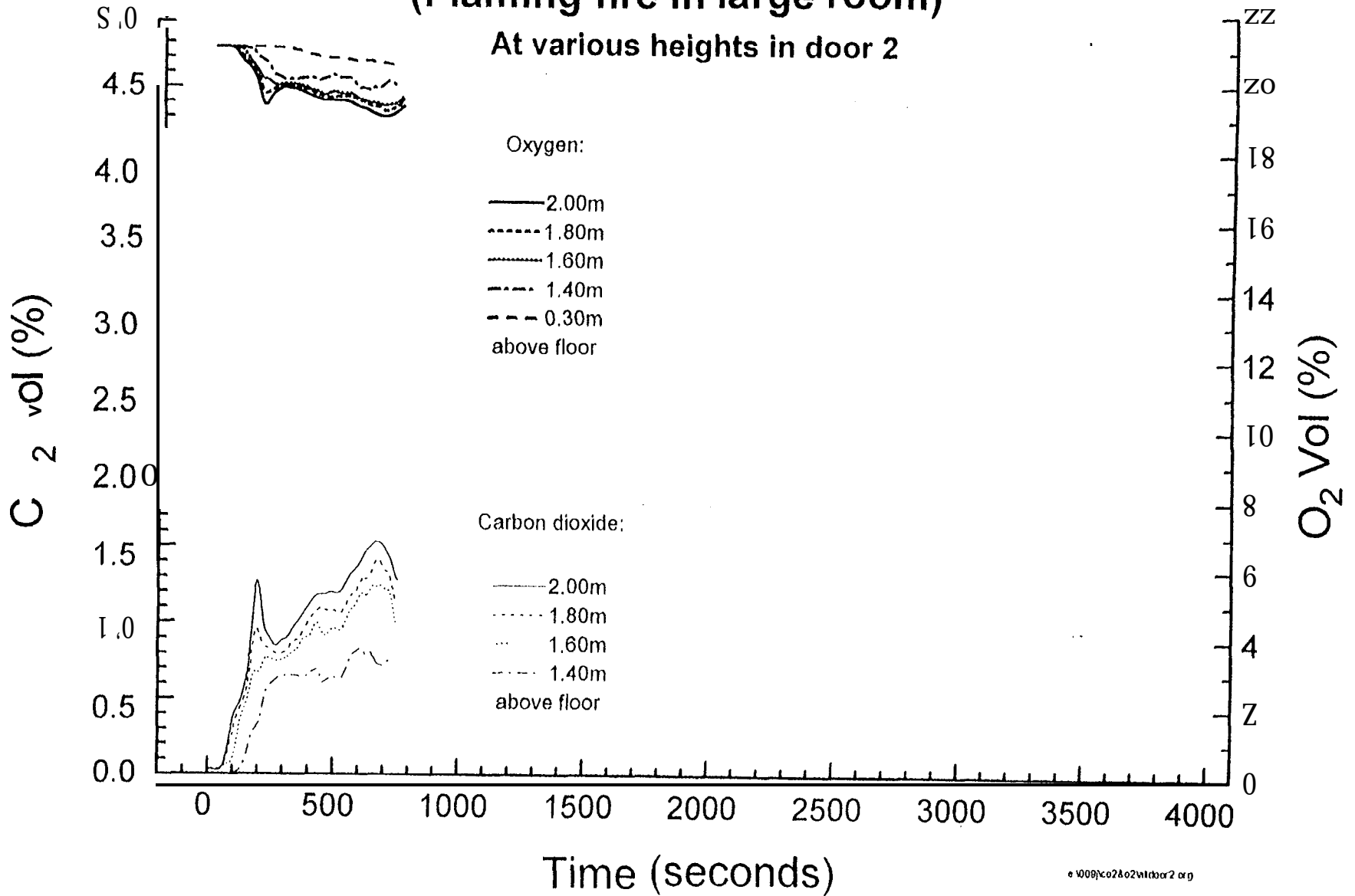

Fig. 8.2.8-1
Smoke obscuration - Test FML1
(flaming fire in large room)

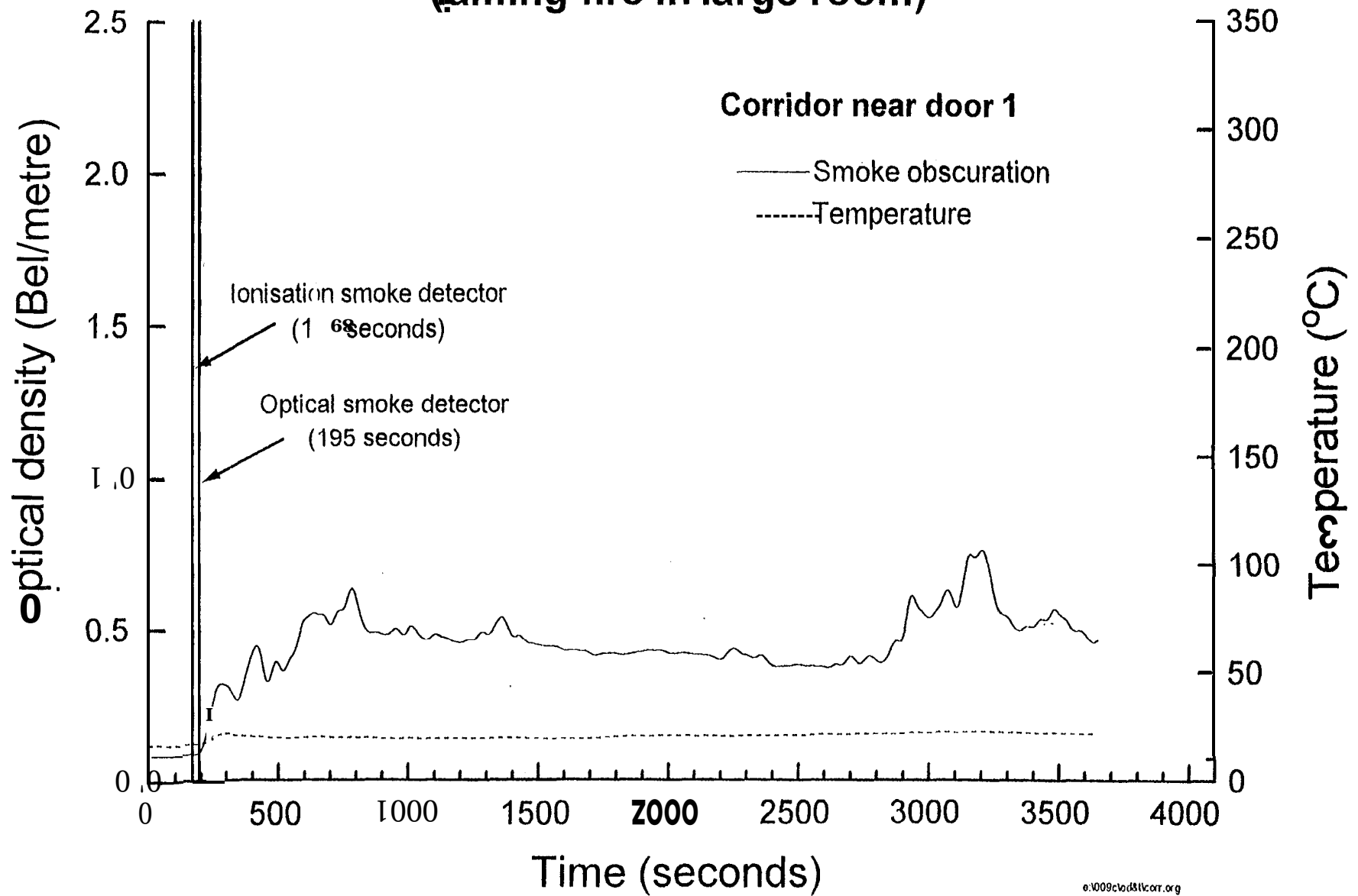

Fig. 8.2.8-2
endtemperature - Test FML2
(Flaming fire in large room)

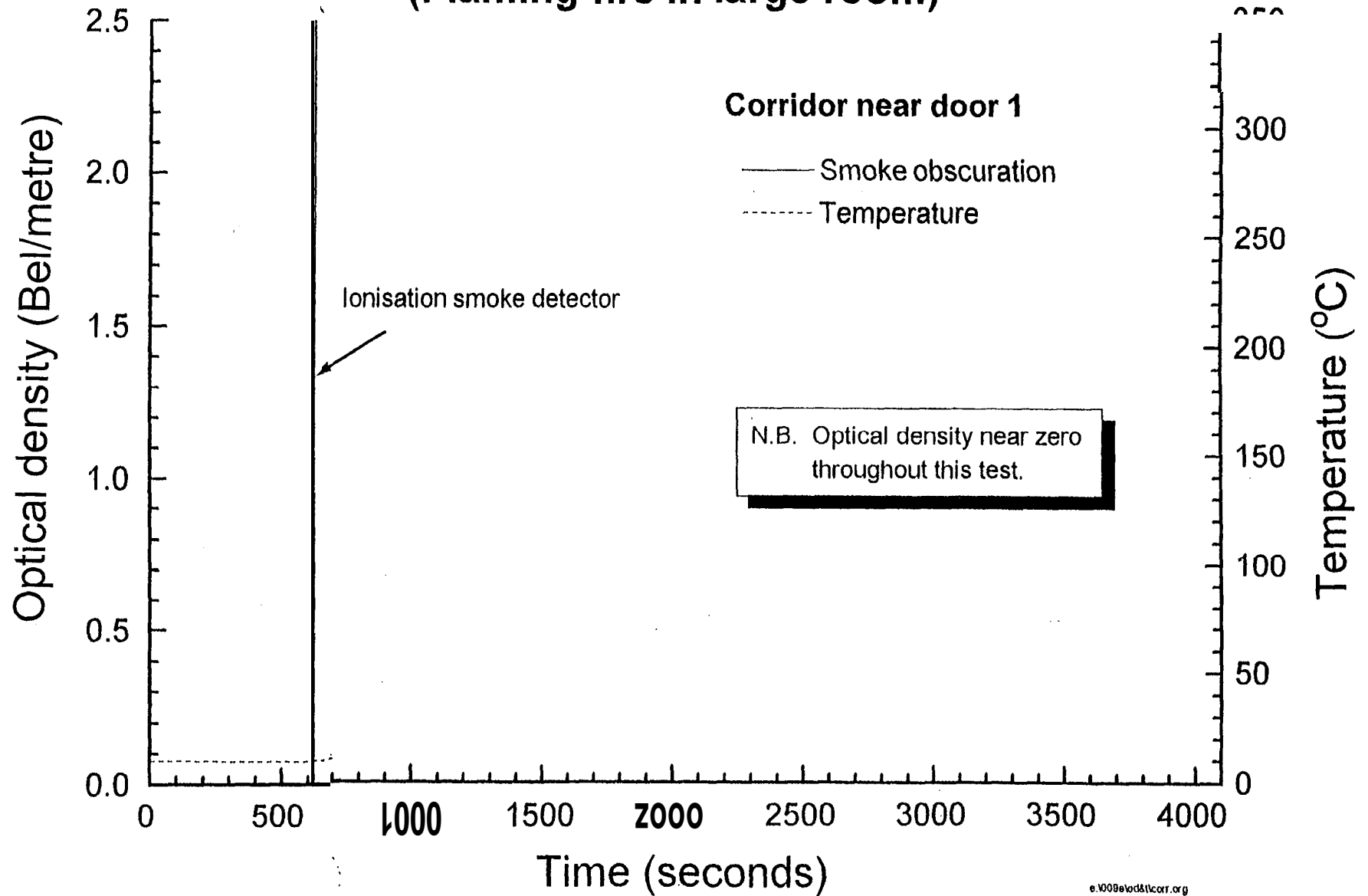

Fig. 8.2.8-3
Smoke obscuration and temperature - Test FML3
(Flaming fire in large room)

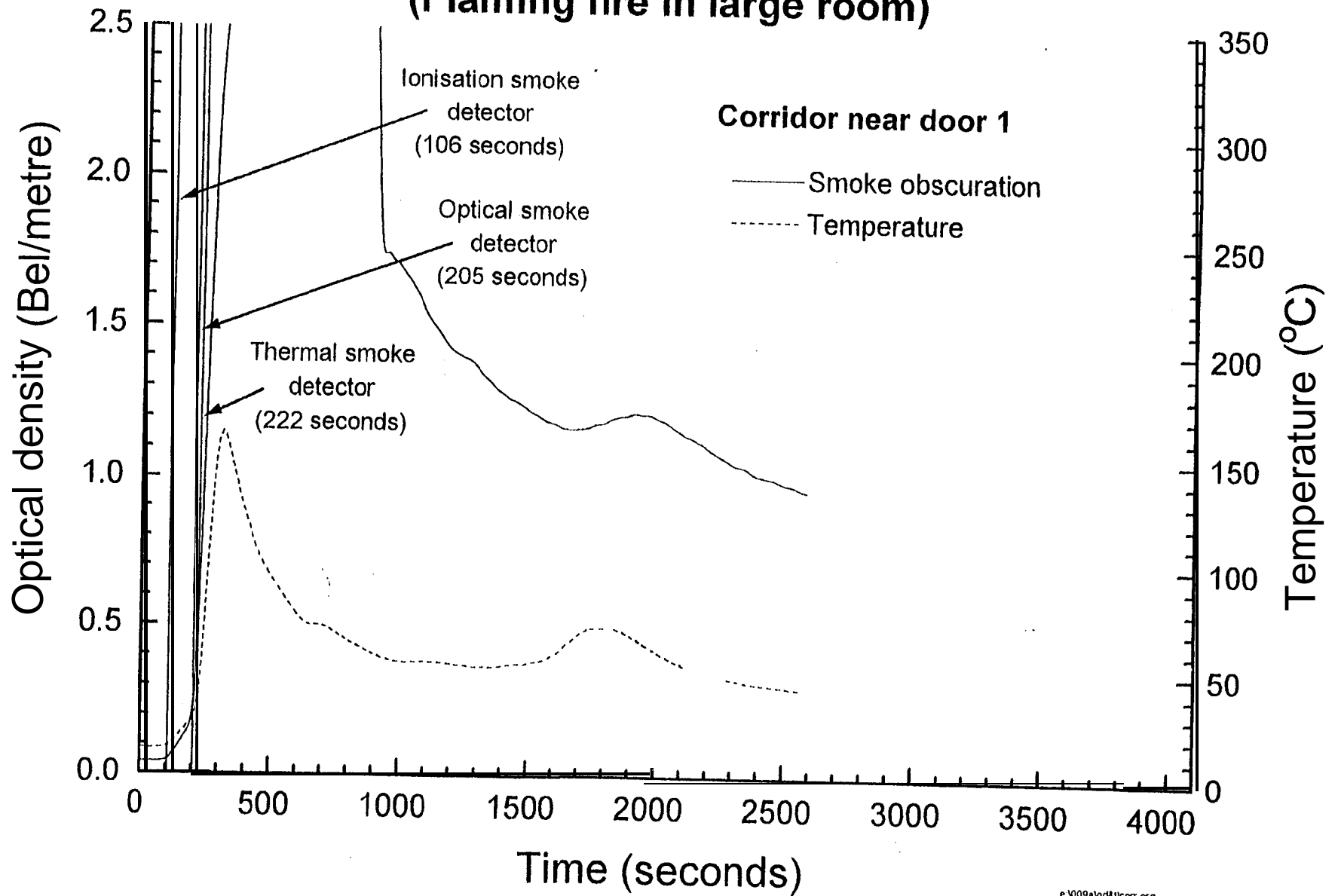

Fig. 8.2.8-4
Smoke obscuration and temperature - Test FM .4
(Flaming fire in large room)

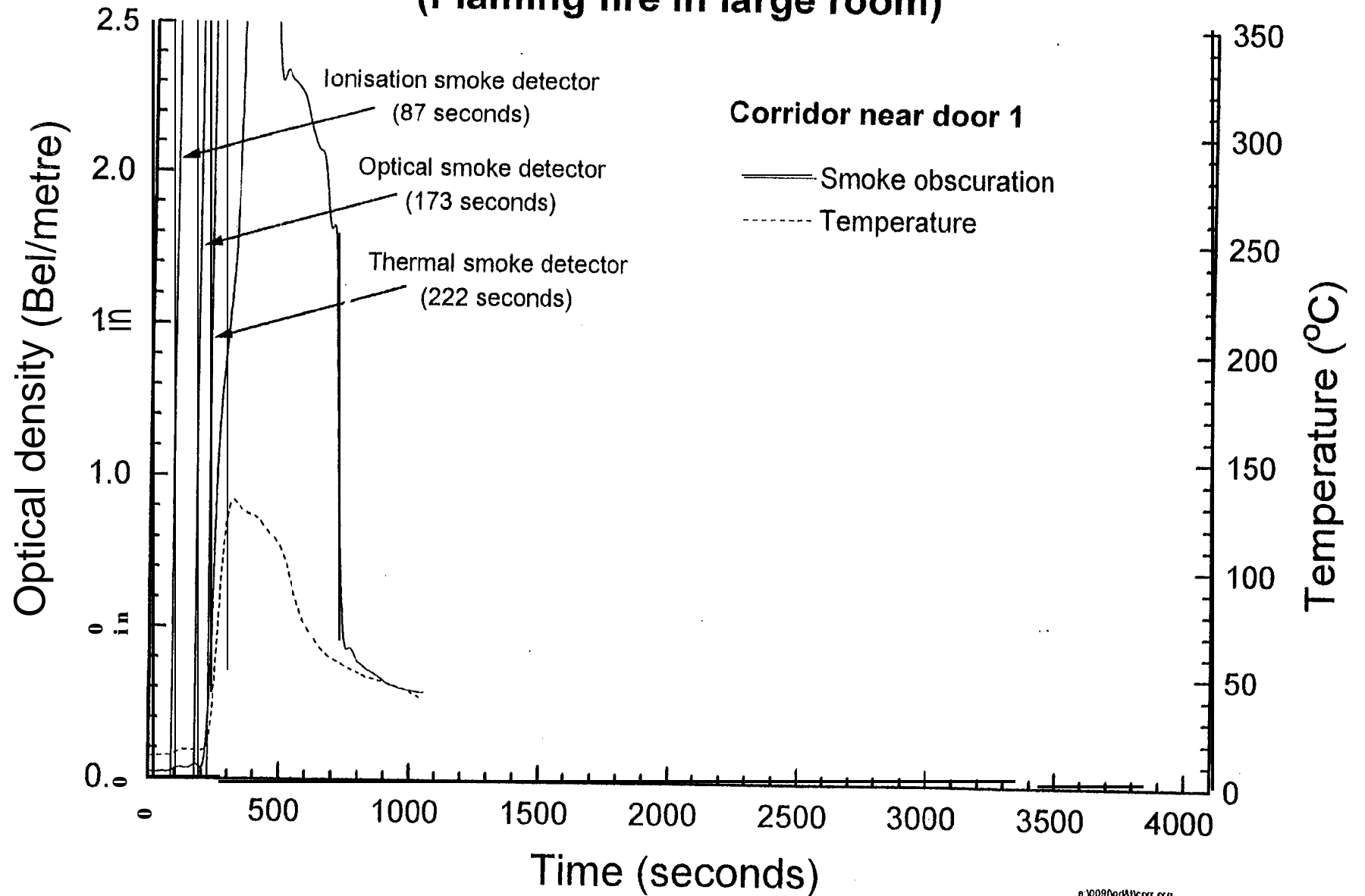

Fig. 8.2.8-5
Smoke obscuration and temperature - Test FML5
(Flaming fire in large room)

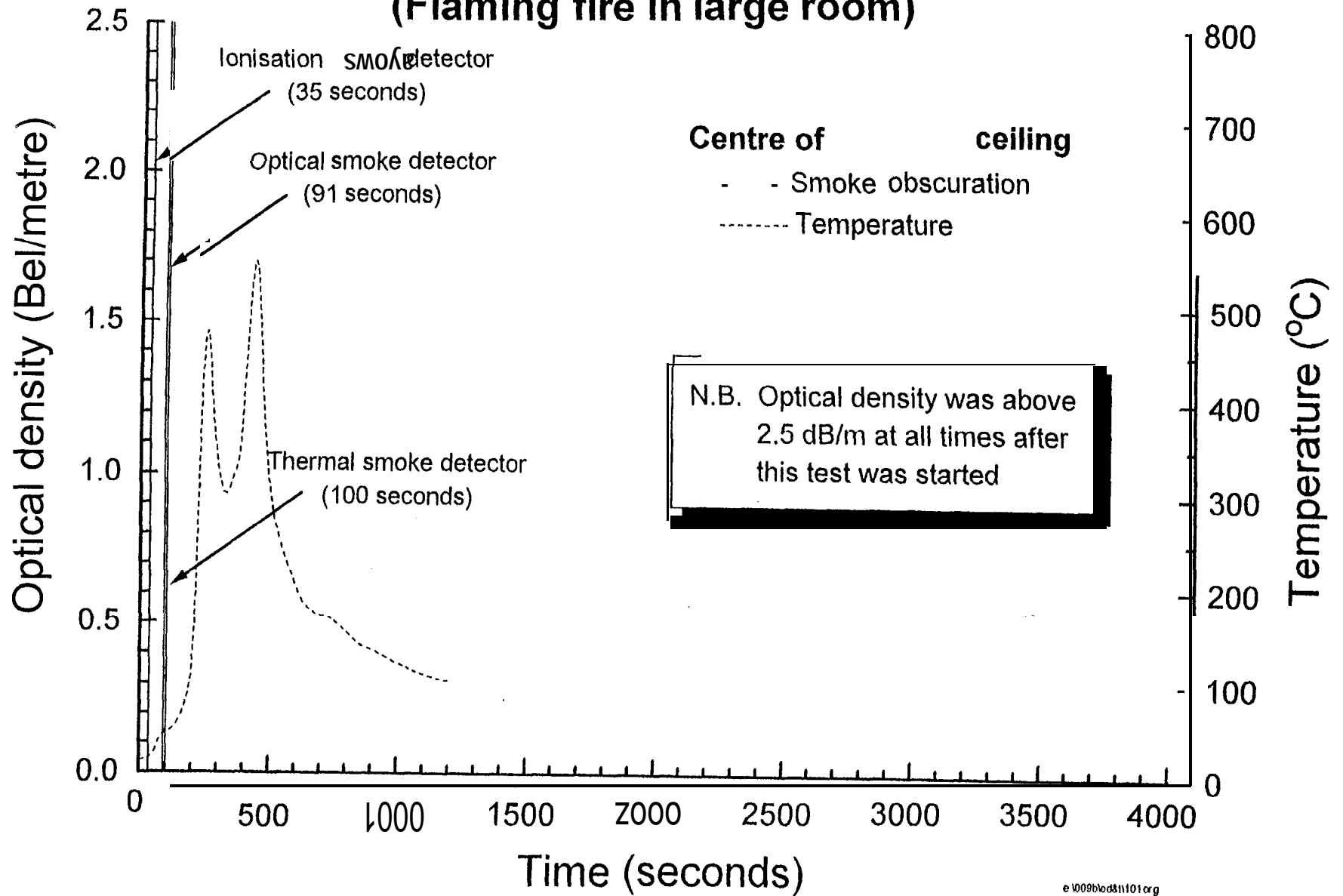

Fig. 8.2.8-6
Smoke obscuration and temperature - Test FML6
(Flaming fire in large room)

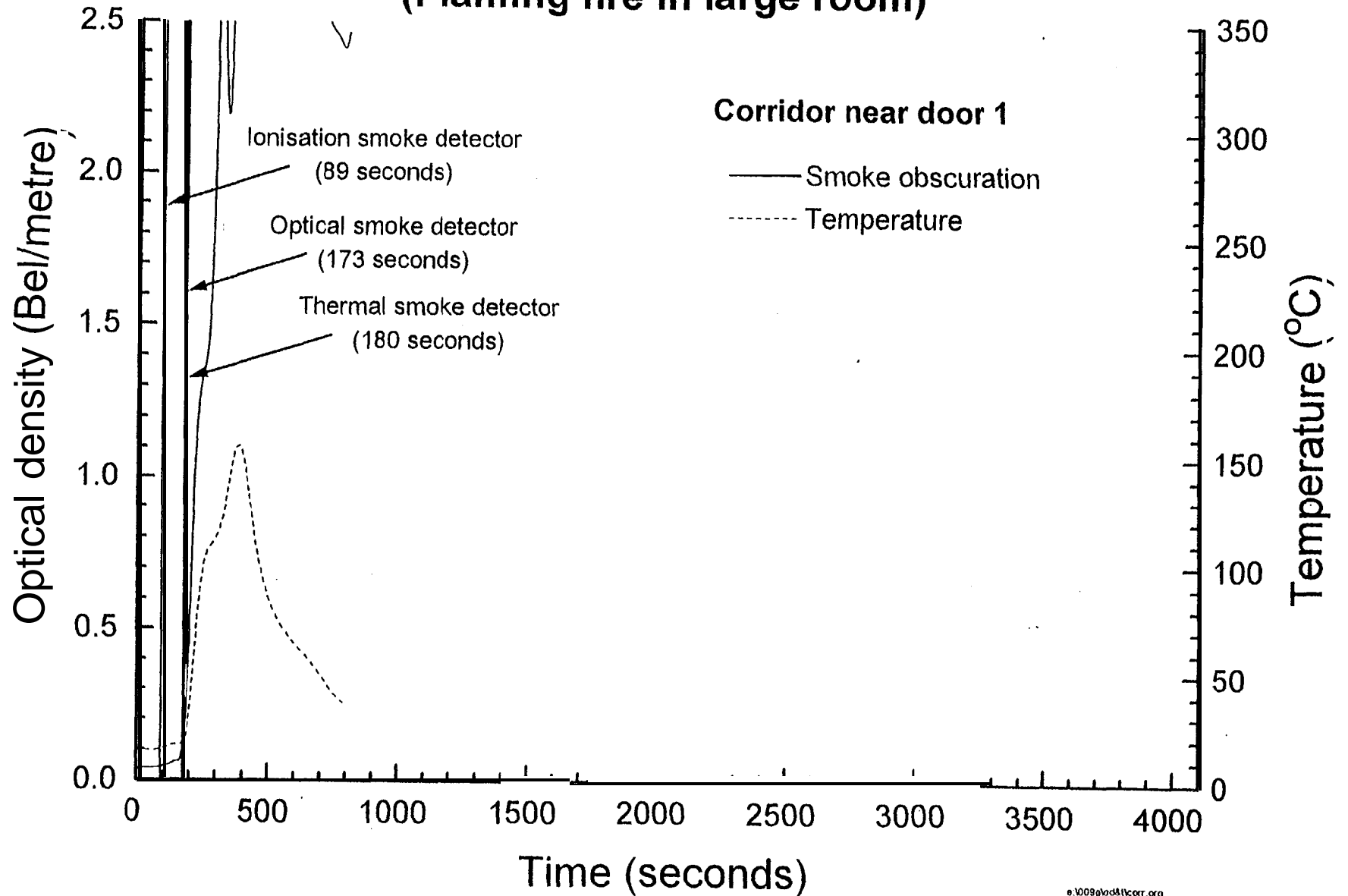

Fig. 8.2.8-7
Smoke obscuration and temperature - Test FML7
(Flaming fire in large room)

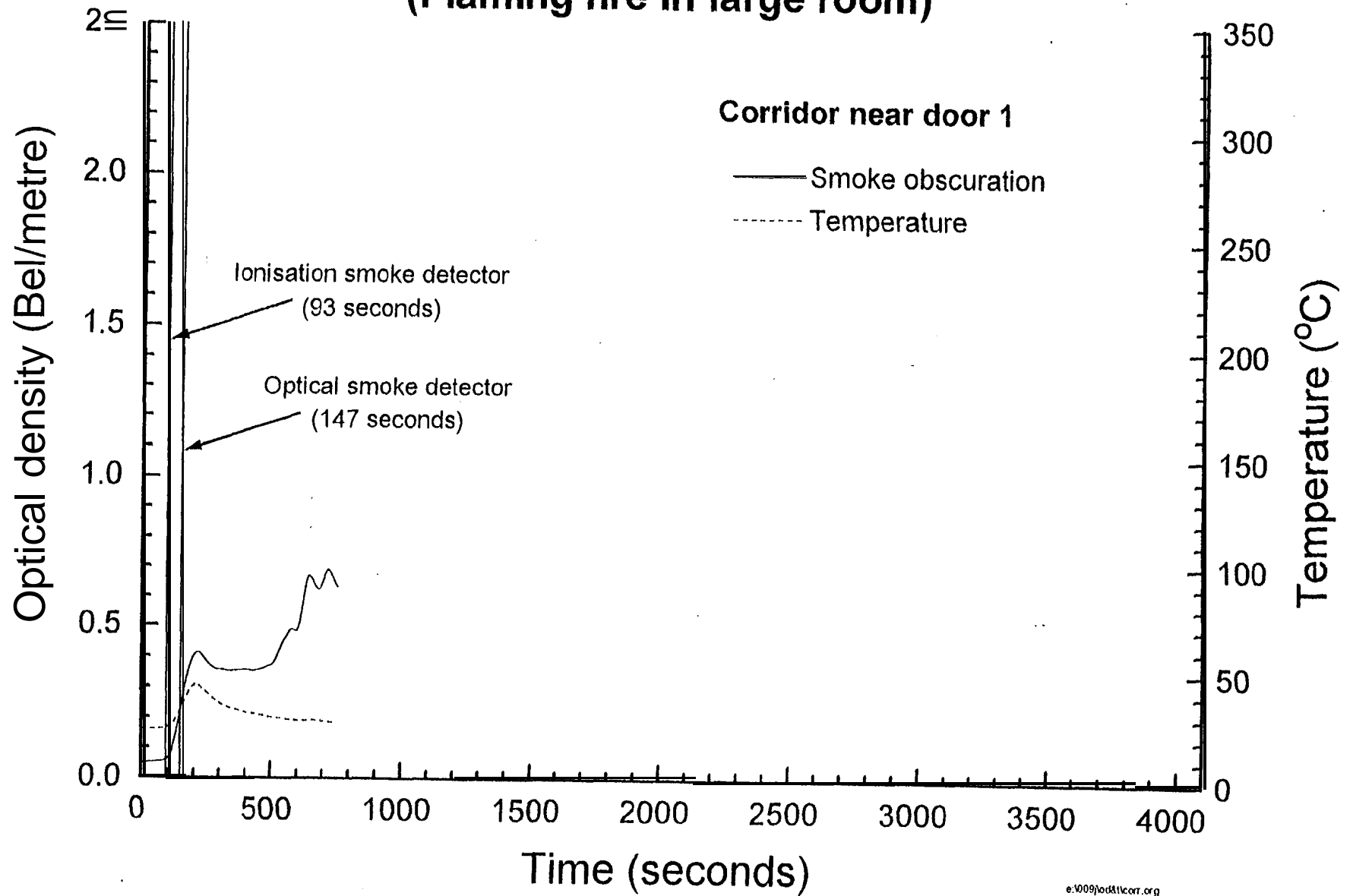

Fig. 8.2.8-8
Smoke obscuration and temperature - Test FML4
(Flaming fire in large room)

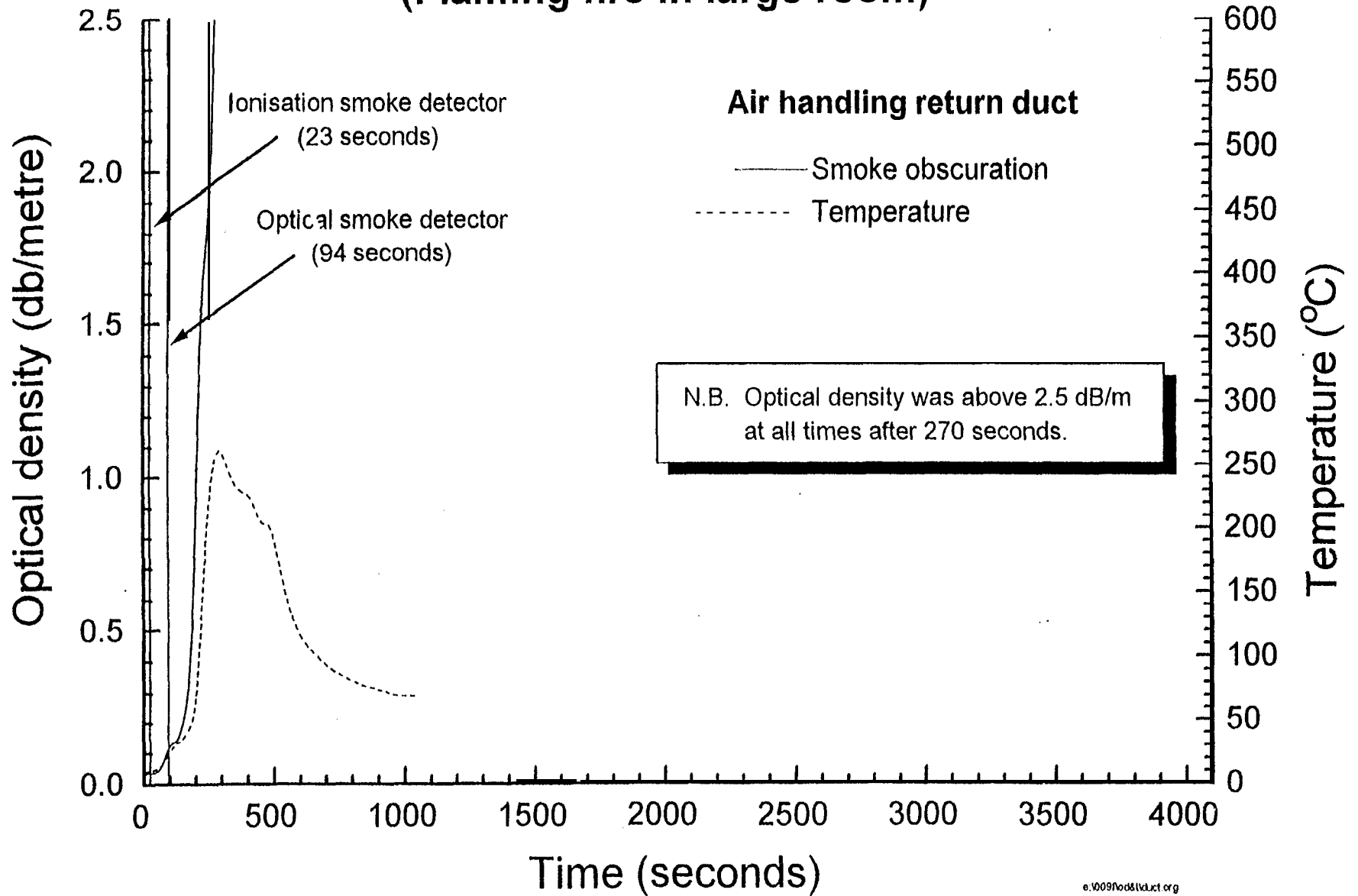

Fig. 8.2.10-1

Air velocity (Flaming fire in large room) - Test FML6

Through door 9

